



ROHM GROUP Short Form Catalog





[Viewing the catalog]

■ **New** indicates new product.

■ ☆ indicates product under development.

■ Classification by the color

- ROHM  Display with this color
- LAPIS Semiconductor  The text displays
LAPIS Semiconductor Product
- Kionix  The text displays Kionix, Inc. Product

———— Company group ————

ROHM GROUP
LAPIS SEMICONDUCTOR
LAPIS Semiconductor Co., Ltd. <http://www.lapis-semi.com/en/>

LAPIS Semiconductor excels in a number of technologies, including wireless communication, low power consumption, digital-analog mixed signals, low power microcontrollers and memory design, and provides logic LSIs, memory LSIs, display driver LSIs, and foundry services.

Products LAPIS Semiconductor is the leading supplier for the Personal & Mobile Applications.

■ Low Power Microcontrollers Remarkably low power consumption contributes to significant energy savings.	■ Display Drivers Extensive lineup from TVs to cars
■ Wireless Communications LSIs Greater comfort and convenience through wireless technology	■ Memory LSIs Reliable, stable, long-term supply































 **Kionix, Inc.** <http://www.kionix.com/>

Kionix, Inc. is a global MEMS inertial sensor manufacturer. Kionix offers high-performance, low-power accelerometers, gyroscopes, and 6-axis combination sensors plus comprehensive software libraries that support a full range of sensor combinations, operating systems and hardware platforms.

Products Incorporates MEMS technology in order to provide market-leading sensors.

■ Accelerometers Offer Industry-Leading Stability and Performance.	■ Gyroscopes Designed to strike a balance between current consumption and noise performance with excellent bias stability over temperature.
■ 6-Axis Combo Parts Offer unparalleled performance.	

INDEX

ICs	 Memory	<i>Includes LAPIS Semiconductor products</i>	See page A1	A
	 Amplifiers & Linear		See page A9	A
	 Clocks & Timers		See page A19	A
	 Switch & IPD & Multiplexer & Logic		See page A21	A
	 Data Converter		See page A25	A
	 Interface		See page A27	A
	 Power Management	<i>Includes LAPIS Semiconductor products</i>	See page A31	A
	 Motor / Actuator Drivers		See page A67	A
	 LED Drivers		See page A79	A
	 Display Drivers	<i>Includes LAPIS Semiconductor products</i>	See page A83	A
	 Sensors & MEMS	<i>Includes LAPIS Semiconductor products Includes Kionix products</i>	See page A87	A
	 Communication LSI	<i>Includes LAPIS Semiconductor products</i>	See page A91	A
	 Audio & Video	<i>Includes LAPIS Semiconductor products</i>	See page A95	A
	 Speech Synthesis LSI	<i>Includes LAPIS Semiconductor products</i>	See page A105	A
	 Microcontroller	<i>Includes LAPIS Semiconductor products</i>	See page A109	A
	 IC Packages	<i>Includes LAPIS Semiconductor products</i>	See page A123	A
Power Devices	 SiC Power Devices		See page B1	B
	 IGBT		See page B9	B
	 Intelligent Power Module		See page B13	B
Discrete Devices	 Transistors		See page C1	C
	 Diodes		See page C59	C
Passive Devices	 Resistors		See page D1	D
	 Tantalum Capacitors		See page D21	D
Opto Devices	 LEDs		See page E1	E
	 LED Displays		See page E17	E
	 Laser Diodes		See page E21	E
	 Optical Sensors		See page E27	E
Modules	 Power Supply Modules		See page F1	F
	 Wireless Modules	<i>Includes LAPIS Semiconductor products</i>	See page F5	F
	 Thermal Printheads		See page F9	F
Part No. List			See page G1	G



Automotive Block Diagram

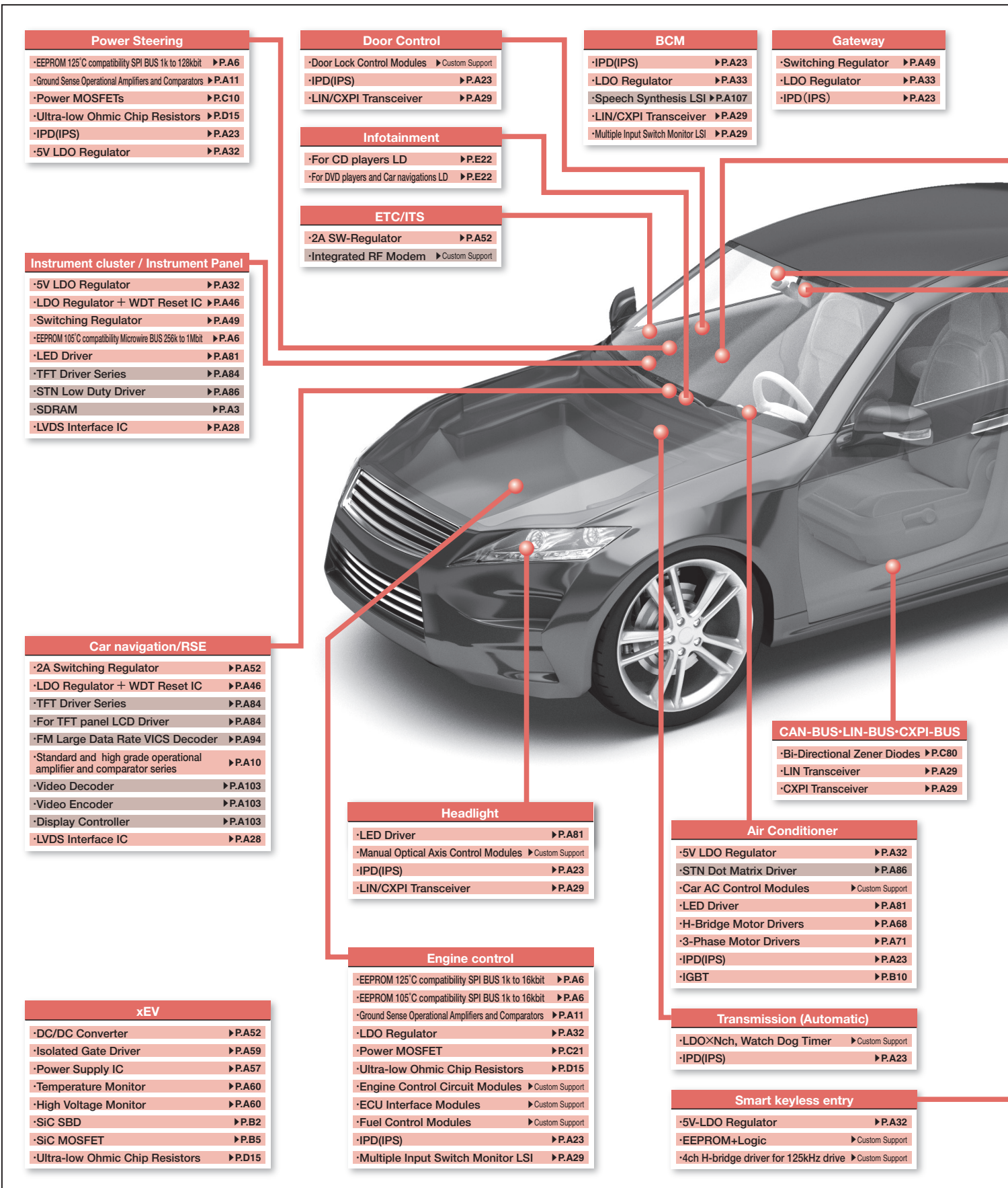

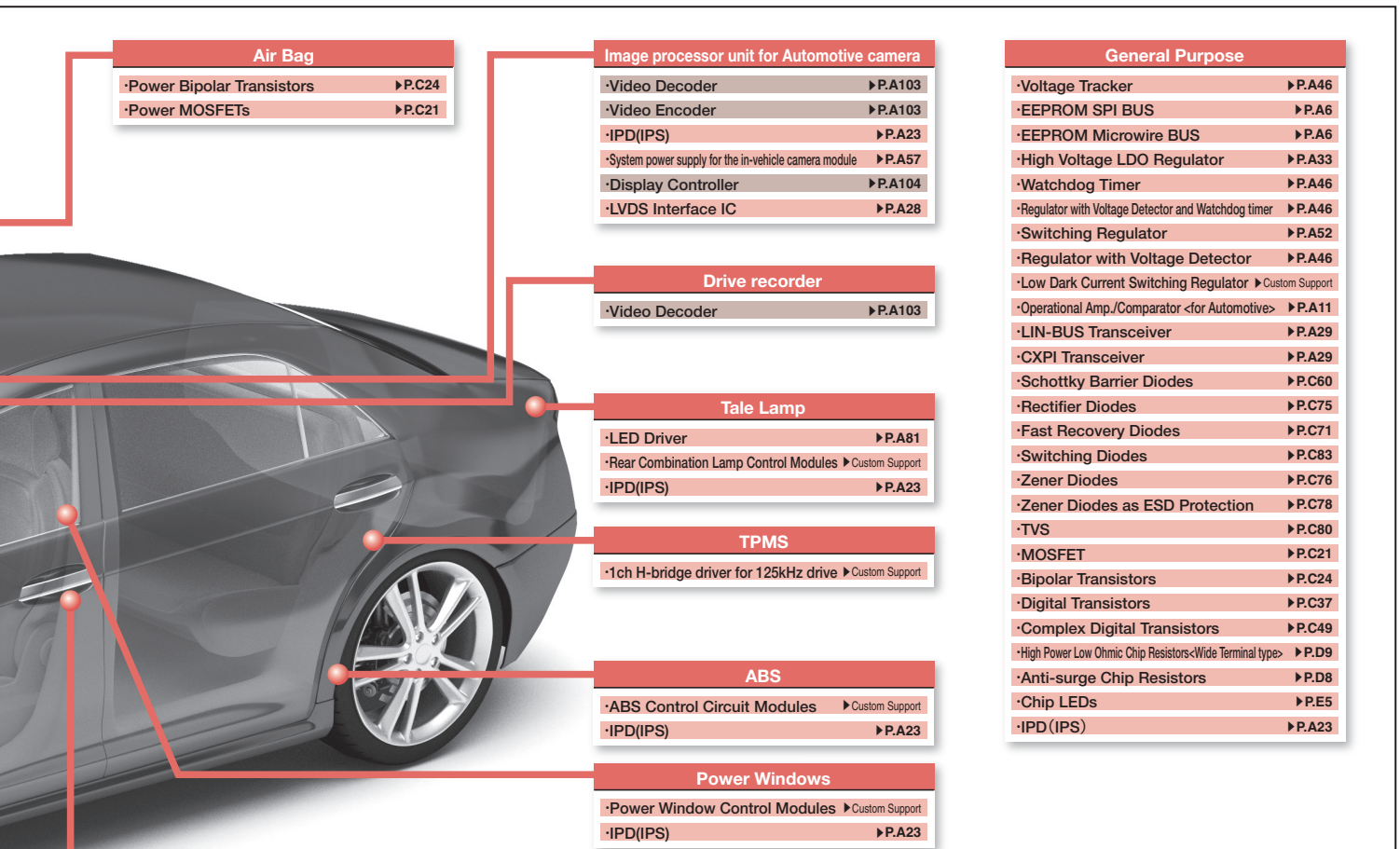

●Car Audio Block Diagram

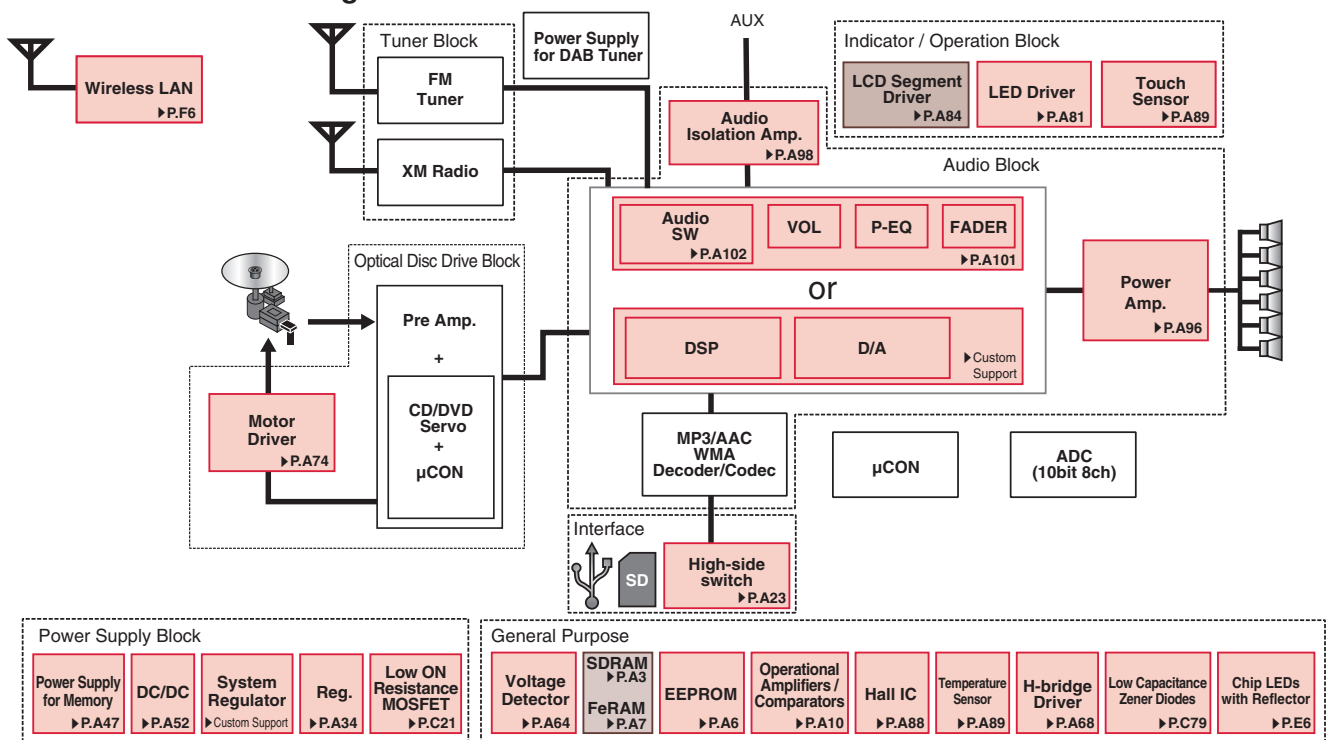



HEMS (Smart House) Block Diagram

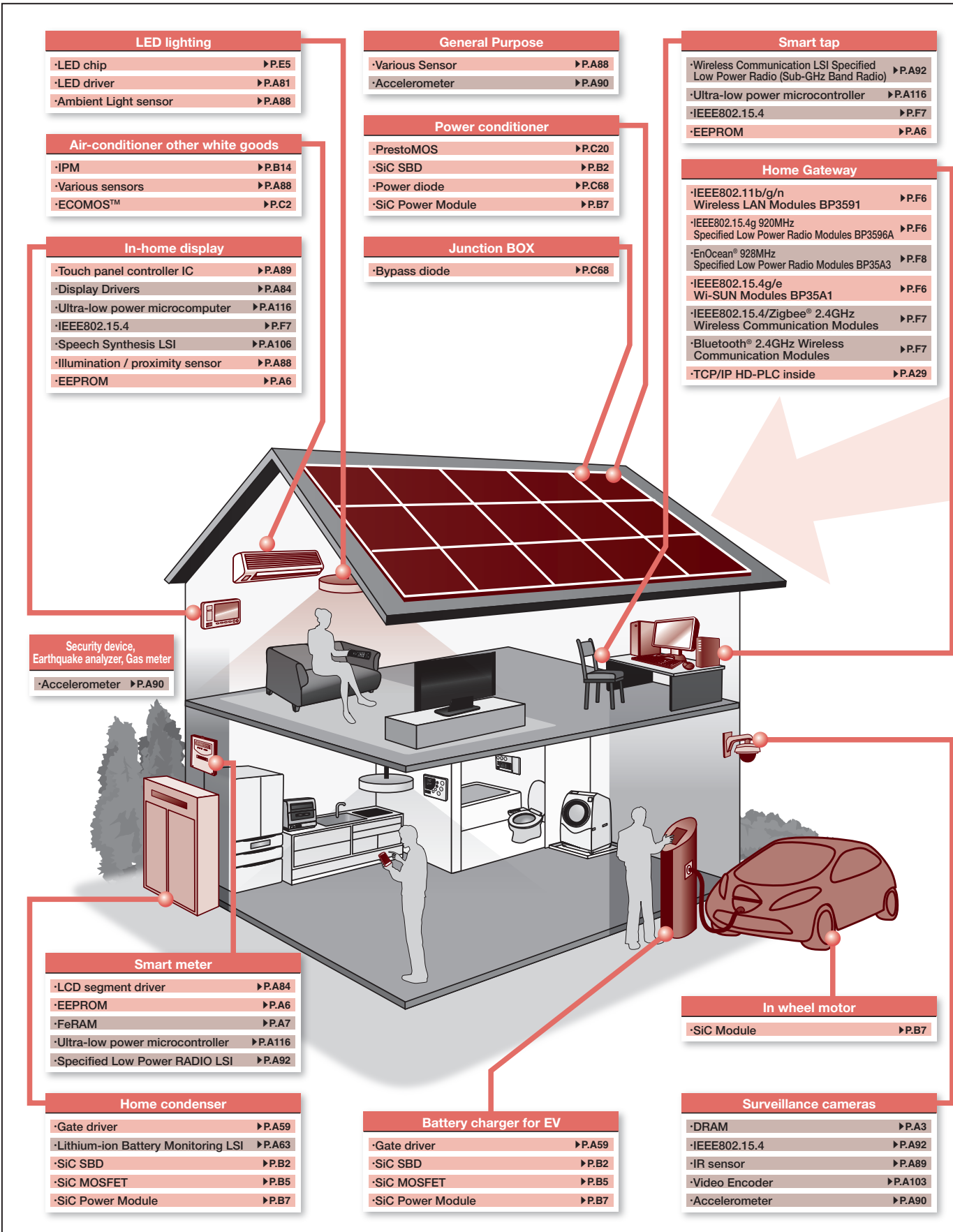

● Solar Inverter Block Diagram

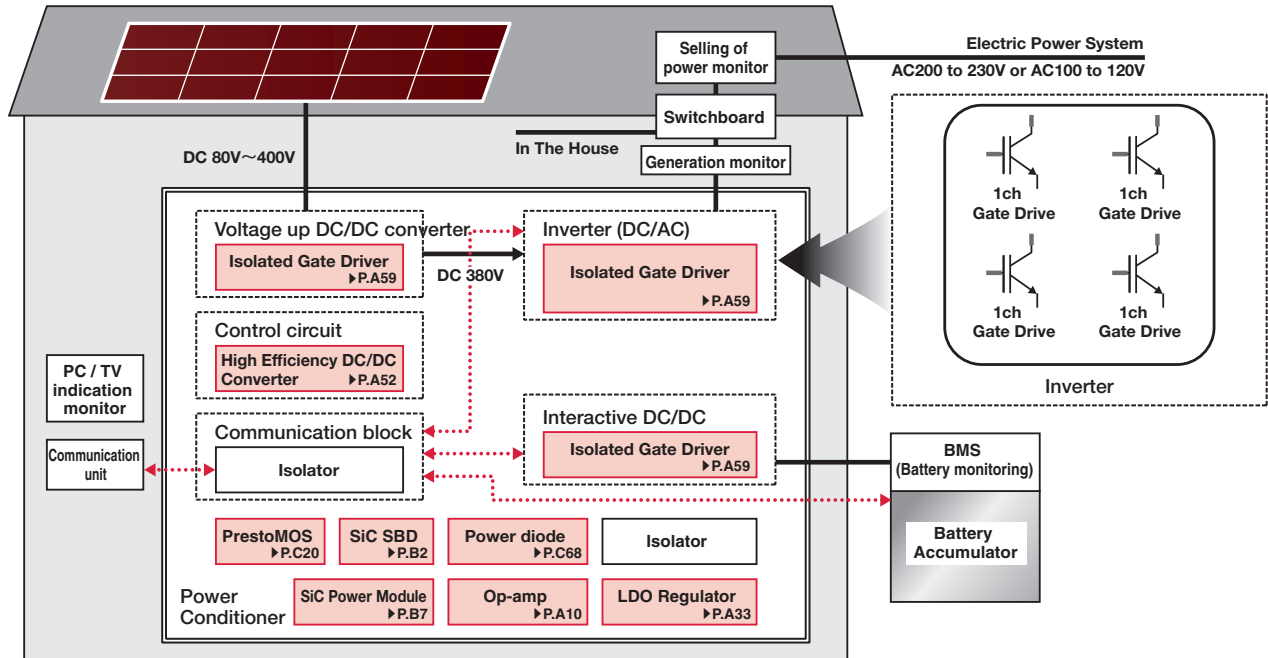

Smartphone / Tablet / Wearable Block Diagram

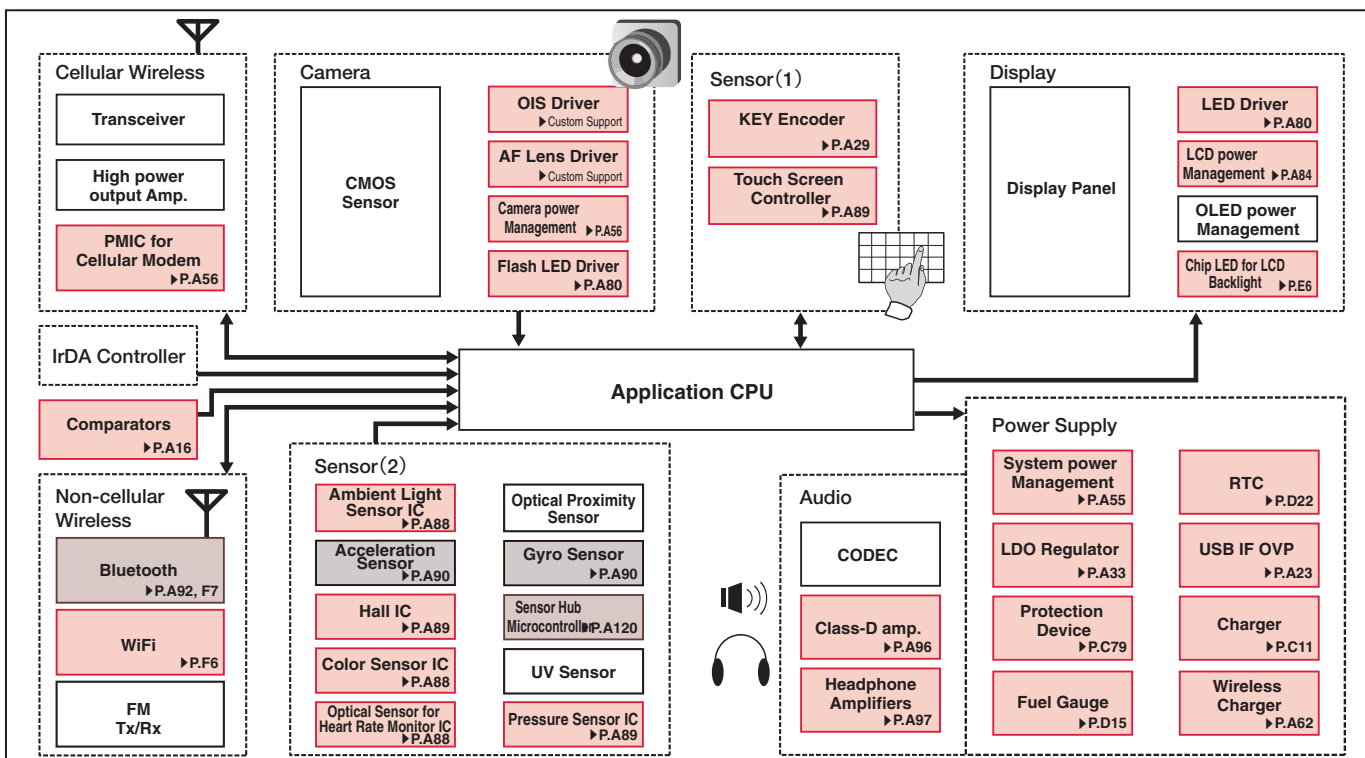

Refrigerator Block Diagram

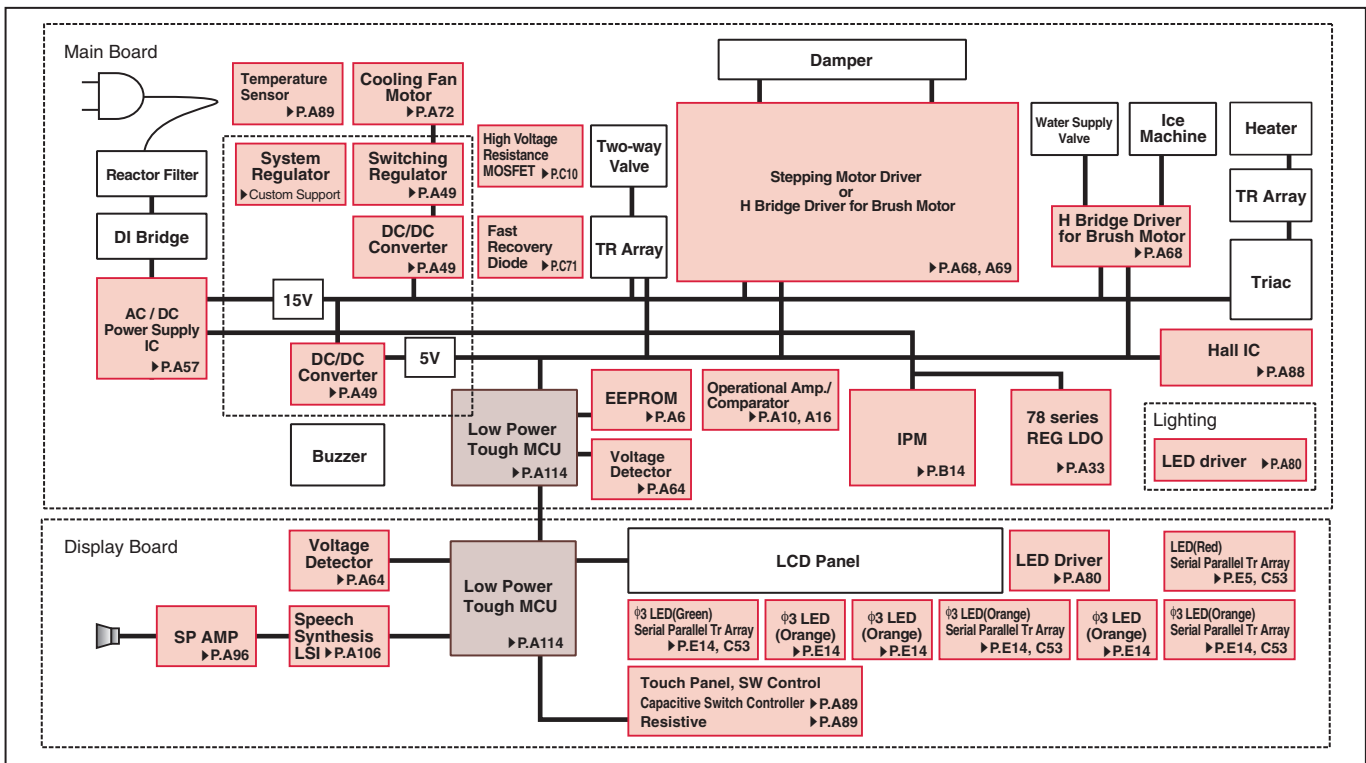

Air-conditioner Block Diagram

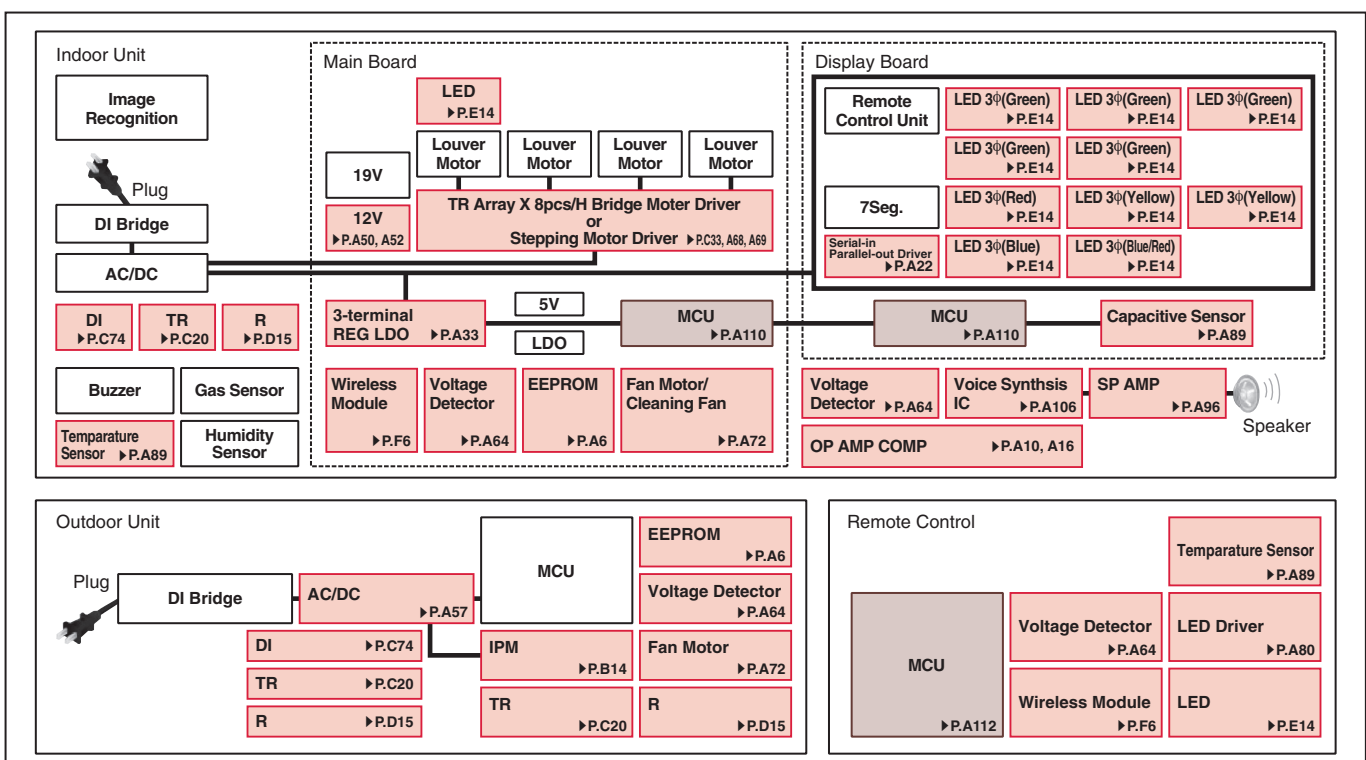

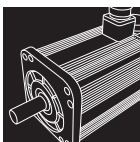

For Motion Control FA Inverter / AC Servo Block Diagram

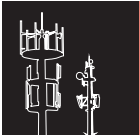
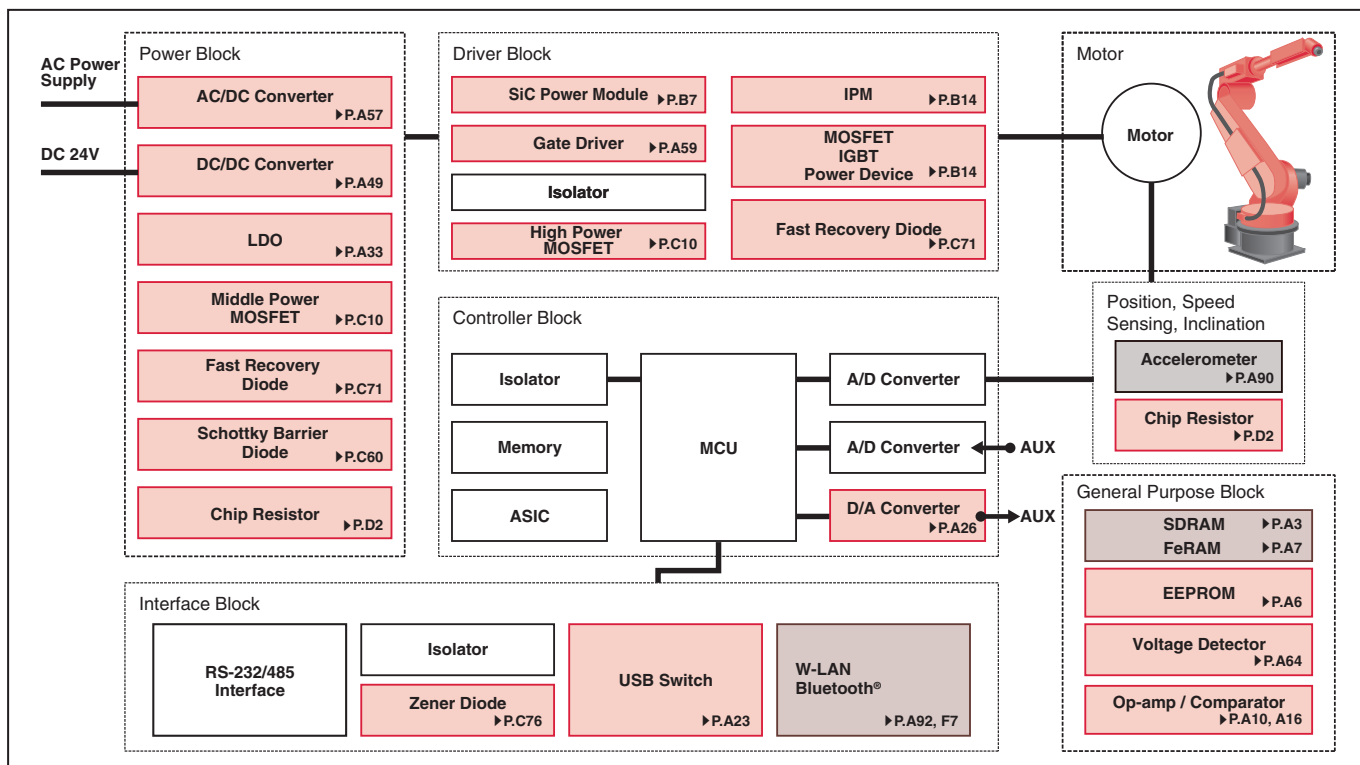

Base Station Block Diagram

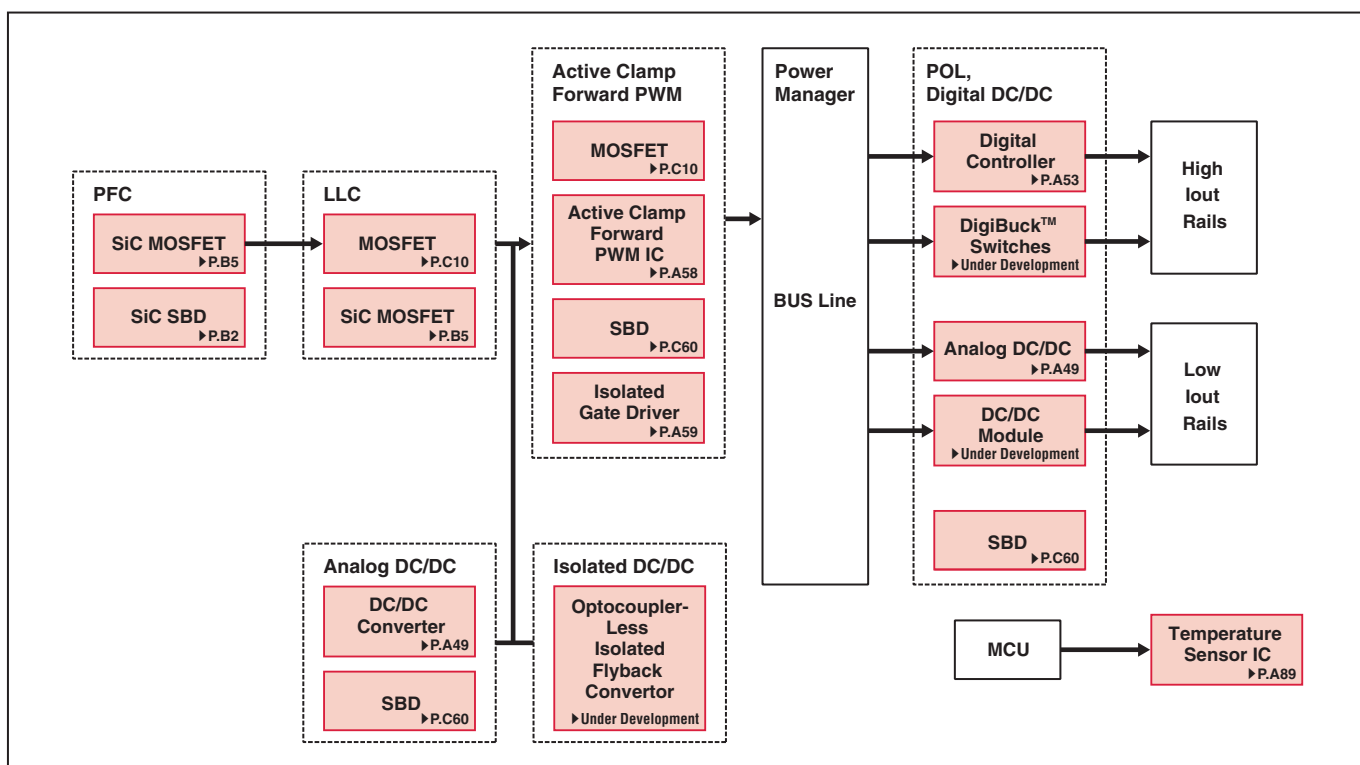

ICs

Memory

SDRAM	A3
Standard Legacy DRAM SDRAM	A3
Industrial Legacy DRAM SDRAM	A3
Automotive Legacy DRAM SDRAM	A3
SDRAM for SiP	A3
Video Memory	A4
Video Memory for Standard	A4
Video Memory for Automotive	A4
Serial EEPROM	A4
Standard EEPROM	A4
Automotive EEPROM	A6
FeRAM	A7
Ferroelectric Memory	A7

IC Amplifiers & Linear

Operational Amplifiers	A10
Standard	A10
High Speed	A11
Low Power Consumption	A13
Low Noise	A15
Low Offset Voltage	A16
Comparators	A16
Standard	A16
High Speed	A17
Low Power Consumption	A17
Transistor Arrays	A18
Darlington Transistor Arrays	A18

IC Clocks & Timers

High-performance Clock Generators ICs	A20
Clock Generators for Digital Cameras	A20
DVD-Audio Reference Clock Generator for A/V Equipments	A20
DVD-Video Reference Clock Generators for A/V Equipments	A20
Clock Generator with Built-in VCXO for A/V Equipments	A20
Real Time Clocks ICs	A20
Real Time Clocks with High-precision Oscillation Adjustment	A20

IC Switch & IPD & Multiplexer & Logic

Standard Logic	A22
Analog Switch/Analog Switch(Single type)	A22
Multiplexer	A22
Logic Gates	A22
Logic Gates(Single type)	A22
Function Logic	A22
Serial-in/Parallel-out Drivers	A22
Serial/Parallel 2-input Drivers	A22
Serial/Parallel 4-input Drivers	A22
USB Switch ICs	A23
SP type(Single Pole)	A23
DP type(Double Pole)	A23
Built-in OVP Micro USB Switch with USB2.0, MHL™ and Audio	A23
IPD(Intelligent Power Device)	A23
High Side Switch	A23
Low Side Switch	A23

IC Data Converter

A/D Converter	A26
10bit	A26
12bit	A26
D/A Converters	A26
8bit	A26
10bit	A26

IC Interface

LVDS Interface ICs	A28
Clockless Link Interface ICs	A28
Timing Controllers	A28
Multiple Input Switch Monitor LSIs	A29
22ch Models	A29
33ch Models	A29
10ch Models	A29
IrDA Controllers	A29
LIN Transceivers	A29
LIN Transceiver	A29
CXPI Transceiver	A29
CXPI Transceiver	A29
PLC(Power Line Communication)	A29
HD-PLC Inside Compliant Baseband IC	A29
Broadband Power Line Communication Baseband IC	A29
USB Type-C Power Delivery	A30
USB Type-C Power Delivery Controllers	A30
For POWER SOURCE	A30
For POWER SOURCE & SINK	A30
For POWER SINK	A30

ICs

IC Power Management

Linear Regulators	A32
78 Series Regulators	A33
Single-Output LDO Regulators	A33
LDO Regulators with Voltage Detector and Watchdog Timer	A46
LDO Regulators with Voltage Detector	A46
Voltage Tracker	A46
Multi-Output LDO Regulators	A47
Linear Regulators for DDR SDRAM	A47
Switching Regulators	A48
Integrated MOSFET Switching Regulators	A49
External Switch Switching Regulators	A51
For Automotive Switching Regulators	A52
Digital Controllers(Powervation) Series	A53
Digital Controllers for Servers/Base Stations(Powervation)	A53
Switching Regulators (System Power Supplies)	A54
System Power Supply ICs for Car Audio	A55
System Power Supply ICs for LCD Panels	A55
Programmable Gamma-Voltage Generator/Gamma Buffer Amp.	A55
System Power Supply ICs for Mobile Phones	A56
System Power Supply ICs for DSC/DVCs	A56
System Power Supply ICs for Automotive	A57
System Power Supply ICs for Industrial/Consumer Applications ..	A57
Isolated/No Isolated Power Supply	A57
AC/DC Converter ICs	A57
Isolated DC/DC Converter ICs	A59
Isolated DC/DC Controller	A59
Gate Drivers	A59
Isolated Gate Drivers	A59
Others	A59
IGBT/MOSFET High-side Low-side Gate Drivers	A59
IGBT/MOSFET High-side Low-side 3 Phase Bridge Driver	A59
High Voltage Monitor	A59
Isolated High Voltage Monitor	A59
Temperature Monitor	A59
Isolated Temperature Monitor	A59
Power Management Switch	A60
1 Channel Compact High Side Switch ICs	A60
1 Channel High Side Switch ICs	A61
2 Channel High Side Switch ICs	A61
Load Switch ICs	A62
1 Channel Compact High Side Load Switch ICs	A62
2 Channel Compact High Side Load Switch IC	A62
Controller IC for High Side NMOSFET	A62
Wireless Power	A62
Receiver ICs	A62
Transmitter ICs	A62
Power Receiver LSI	A62
Power Transmitter LSI	A62
Battery Management	A63
Battery Charger ICs	A63
Solar Charge Management IC	A63
Charge Protection ICs	A63
Cell Balance IC of Power Storage Element Cells	A63
Li-ion Battery Monitoring LSIs	A63
Voltage Detectors(Reset ICs)	A64
Voltage Detectors(Reset ICs)	A64
Voltage Detectors with Adjustable Delay Time	A65
Voltage Detectors with Built-in Delay Time	A65

Voltage Detectors for Automotive	A66
Others	A66
Voltage Detectors with Watchdog Timer	A66
Composite type Voltage Detectors(2ch+Comparator)	A66

IC Motor / Actuator Drivers

DC Brush Motor Drivers	A68
7V Max. H-Bridge Drivers	A68
18V Max. H-Bridge Drivers	A68
36V Max. H-Bridge Drivers	A68
40/60V Max. H-Bridge Drivers	A68
H-Bridge Drivers High-Current Series	A68
H-Bridge Drivers High-Speed Series	A68
1.0A Reversible Motor Drivers(Single Motor)	A68
2.0A or More Reversible Motor Driver(Single Motor)	A69
1.0A or More Reversible Motor Driver(2 Motors)	A69
Stepper Motor Drivers	A69
High Performance, High Reliability 36V Stepper Motor Drivers	A69
Standard 36V Stepper Motor Drivers	A70
Microstep 36V Stepper Motor Drivers	A70
Low Voltage Stepper Motor Drivers	A70
45V Stepper Motor Drivers	A71
3-Phase Brushless Motor Drivers	A71
3-Phase Brushless Motor Pre-Driver with Speed Control	A71
3-Phase Brushless Motor Driver with Speed Control	A71
3-Phase Brushless Motor Pre-Drivers	A71
3-Phase Brushless Motor Drivers	A71
Fan Motor Drivers	A72
5V Single-Phase Full-wave Fan Motor Drivers	A72
Standard Single-Phase Full-wave Fan Motor Drivers	A72
Multifunction Single-Phase Full-wave Fan Motor Drivers	A73
2-Phase Half-wave Fan Motor Drivers	A73
3-Phase Full-wave Fan Motor Drivers	A73
3-Phase Brushless Fan Motor Drivers	A74
3-Phase Brushless Fan Motor Controllers	A74
Driver for ODD	A74
1ch System Motor Driver ICs	A74
2ch to 3ch System Motor Driver IC	A74
4ch System Motor Driver ICs	A74
5ch System Motor Driver ICs	A74
6ch to 9ch System Motor Driver ICs	A75
System Motor Driver ICs for Half Height Drives(Sensorless)	A75
System Motor Driver ICs for Slim Drives(3 sensors)	A75
Drivers for Printer	A75
3-Phase Brushless Motor Driver for Polygonal Mirrors	A75
Motor Drivers with Brush for Printers	A75
Bipolar Stepper Motor Drivers for Paper Feed/Carriage	A75
3-Phase Brushless Motor Pre-Drivers for Paper Feed	A75
Driver for Digital Still Camera	A76
5ch System Lens Drivers for Digital Still Cameras	A76
6ch System Lens Drivers for Digital Still Cameras	A76
7ch System Lens Drivers for Digital Still Cameras	A76
Single- and Dual-Channel Lens Drivers for SLRs(Single Lens Reflex)	A76
Microstep System Lens Drivers for Digital Cameras	A77
Mobile Phone Module Drivers	A78
Parallel Interface Lens Driver for Voice Coil Motors	A78
2-wire Serial (I ² C-compatible) Interface Lens Drivers for Uni-directional Voice Coil Motors	A78
2-wire Serial (I ² C-compatible) Interface Lens Drivers for Bi-directional Voice Coil Motors	A78
2-wire Serial (I ² C-compatible) Interface Lens Driver for Piezo Actuators	A78
Parallel Interface Lens Driver for Stepping Motors	A78

ICs

IC LED Drivers

LED Drivers	A80
Boost Converter LED Drivers	A80
Buck Converter LED Drivers	A81
Buck-Boost LED Drivers	A81
LED Drivers for Lighting	A81
Inductorless(Charge Pump) LED Drivers	A81
Constant Current/Serial-in Parallel-out LED Drivers	A82
LED Driver Support Function	A82

IC Display Drivers

TFT Driver Series	A84
Driver for Large LCD Panels	A84
Drivers for Small to Medium LCD Panels	A84
TN/STN LCD Driver Series	A84
LCD Segment Drivers	A84
Common/Segment Drivers for Dot Matrix LCD	A85
Controller Drivers for Graphic LCD	A85
Controller Drivers for Character LCD	A85
Controller Drivers for Low Duty LCD	A86
VFD Driver Series	A86
Anode/Grid Drivers for VFD	A86
Controller Drivers for Character VFD	A86
Controller Drivers for Low Duty VFD	A86
Car Clock Drivers	A86

IC Sensors & MEMS

Hall ICs	A88
Omnipolar Detection Hall ICs	A88
Omnipolar Detection Hall ICs with Polarity Discrimination (Polarity Detection for Both S and N Features Dual Outputs)	A88
Bipolar Latch Hall IC	A88
Ambient Light Sensor ICs	A88
Analog Current Output type Ambient Light Sensor ICs	A88
Digital 16bit Serial Output type Ambient Light Sensor ICs	A88
Color Sensor ICs	A88
Digital 16bit Serial Output type Color Sensor ICs	A88
Optical Sensor for Heart Rate Monitor ICs	A88
Optical Sensor for Heart Rate Monitor ICs	A88
Pressure Sensor ICs	A89
Digital Pressure Sensor ICs with Built-in Temperature Compensation Function	A89
Temperature Sensor ICs	A89
Analog Output Temperature Sensor IC	A89
Digital Output Temperature Sensor IC	A89
Low Power Thermostat Output Temperature Sensor IC	A89
Amplifier for Human Body Detector IC	A89
Pyroelectric Infrared Sensor Amplifier	A89
Switch Controller ICs	A89
Capacitive Switch Controller ICs	A89
Touch Screen Controller ICs	A89
Resistive type	A89
Touch Screen I/F LSIs Supporting SPI/I ² C	A89
Accelerometers	A90
3-Axis Accelerometers	A90
6-Axis Combo Sensors	A90
3-Axis Accelerometer + 3-Axis Gyroscope	A90
3-Axis Accelerometer + 3-Axis Magnetometer	A90
Infrared Image Sensor	A90
Infrared(IR) Sensor	A90

ICs

IC Communication LSI

Digital Terrestrial Broadcasting Reception LSI	A92
Japanese System(ISDB-T)	A92
Wireless Communication LSIs	A92
IEEE802.15.4	A92
Bluetooth®	A92
Specified Low Power Radio(Sub-GHz band radio)	A92
LPWA	A93
MCU Included Specified Low Power Radio(Sub-GHz band radio)	A93
System LSI	A93
VoIP LSIs	A93
VoIP CODEC	A93
Echo Canceller LSIs	A93
Echo Canceller	A93
Echo Canceller/Noise Canceller	A93
CODEC LSIs	A94
PCM CODEC	A94
ADPCM CODEC	A94
Car Communication LSIs	A94
FM Data Broadcast Reception LSIs	A94

IC Audio & Video

Audio Amplifiers	A96
Speaker Amplifiers	A96
Headphone Amplifiers	A97
Others	A98
Audio Subsystems	A98
Line Amplifiers	A98
Isolation Amplifiers	A98
Audio Processors	A98
Analog Audio Processors	A98
AUDIO SoCs	A101
Media Decoders	A101
Video Amplifiers	A102
Composite Video Amplifiers	A102
Video Switches	A102
Others	A102
Isolation Amplifier	A102
Audio Converters	A103
Audio Codec	A103
Image Correction	A103
Image Correction ICs for Panel	A103
Video Encoders Built-in Image Correction	A103
Video LSIs	A103
Video Decoder	A103
Video Encoder	A103
Video Interface	A103
Display Controller Series for Small to Medium-Sized TFT LCD	A104

IC Speech Synthesis LSI

Speech Synthesis LSI with Built-in Large-capacity P2ROM™	A106
Speech Synthesis LSI with Built-in Medium/Small-capacity Flash/Mask ROM	A106
Speech Synthesis LSI with External Memory	A107

Microcontroller

High Functionality, High Performance & Low Power Tough MCU(High Noise Immunity)	A110
16bit ML621000 series	A110
Low Power Tough MCU(High Noise Immunity)	A114
8bit ML6101xx	A114
16bit ML6201xx	A114
High Performance & Ultra Low Power MCU	A116
16bit ML6205xx/ML6204xx	A116
32bit ML6304xx(Cortex-M)	A116
Ultra Low Operating Voltage & Ultra Low Power MCU	A116
8bit ML6104xx	A116
Built-in Speech Output Function MCU	A120
8bit ML6103xx	A120
Sensor Hub MCU	A120
8bit ML61079x	A120
32bit ML63079x	A120

IC IC Packages

ROHM Packages

Part No. Explanation	A124
Package Ordering Units	A125
QFP Packages	A126
VMMP Package	A128
SON Packages	A129
QFN Packages	A130
SOP Packages	A132
HSOP Packages	A134
Small Packages	A136
Non-Lead Packages	A136
Power Packages	A137
BGA Packages	A139
WL-CSP Packages	A141

LAPIS Semiconductor Packages

Package List	A142
Part No. Explanation	A142
SOP Packages	A143
QFP Packages	A146
DIP Package	A148
QFN Packages	A149
WSON Package	A150
BGA Packages	A151
LGA Package	A152
WL-CSP Package	A152

Contents

Power Devices

SiC SiC Power Devices

SiC Schottky Barrier Diodes	B2
SiC MOSFET	B5
Full SiC Power Modules	B7

IGBT IGBT

Field Stop Trench IGBT	B10
Ignition IGBT	B12

IPM Intelligent Power Modules

IGBT-IPM	B14
MOS-IPM	B14

Discrete Devices

Tr Transistors

MOSFETs	C2
Small Signal MOSFETs	C2
Power MOSFETs	C10
Selector Guide for Automotive MOSFETs	C21
Selector Guide for Automotive Power MOSFETs	C22
Bipolar Transistors	C24
Bipolar Transistors	C24
Complex Bipolar Transistors	C32
Digital Transistors	C37
Digital Transistors	C37
Complex Digital Transistors	C49
Transistor Arrays	C53
Packages	C54
Part No. Explanation	C56

Di Diodes

Schottky Barrier Diodes	C60
Small Signal Type Schottky Barrier Diodes	C60
Middle Power Schottky Barrier Diodes	C65
Power Schottky Barrier Diodes	C68
Fast Recovery Diodes	C71
Small Signal/Middle Power Fast Recovery Diodes	C71
Power Fast Recovery Diodes	C72
Rectifier Diodes	C75
Zener Diodes	C76
Zener Diodes as ESD Protection	C78
TVS	C80
Switching Diodes	C83
High Frequency Diodes	C85
Packages	C86
Product No. Explanation	C88

Passive Devices

R Resistors

Quick Reference of Resistance Range	D2
Class-leading Compact Size Chip Resistors (RASMID series)	
Ultra-Compact Chip Resistors (SMR003 <009005>)	D3
Thick Film Chip Resistors (Standard series)	
Compact Chip Resistors (MCR series <01005 to 0805>)	D4
Chip Resistors (MCR series <1206 to 2512>)	D5
Compact Chip Resistor Networks (MNR series <0402×2 to 1206×4>)	D6
8-element Chip Resistor Networks (MNR series <0603×5 to 1206×5>)	D7
Thick Film Chip Resistors (High Reliability series)	
High Anti-surge Chip Resistors (SDR series)	D8
Anti-surge Chip Resistors (ESR series)	D8
High Power Chip Resistors <Wide Terminal type> (LTR series)	D9
High Voltage Resistance Chip Resistors (KTR series)	D10
Tolerance for sulfurization Chip Resistor (SFR series)	D11
Chip Resistors for Current Detection (Thick Film type)	
Chip Resistors (Low Ohmic MCR series)	D12
Low Ohmic Chip Resistors <Face Down type> (UCR series)	D13
High Power Chip Resistors <Wide Terminal type> (Low Ohmic LTR series)	D14
Chip Resistors for Current Detection (Metal Plate type)	
Ultra Low Ohmic Chip Shunt Resistors (PMR series)	D15
Ultra Low Ohmic Chip Shunt Resistors <Wide Terminal type> (PML series)	D16
High Power Ultra Low Ohmic Chip Shunt Resistors (PSR series)	D17
High Power Low Ohmic Chip Shunt Resistors (GMR series)	D18
Standard Nominal Resistance Values	D19

Tc Tantalum Capacitors

Conductive Polymer Capacitors

New Bottom Surface Electrode(Extra Large Capacitance) : TCSO series	D22
M case : 1608-10(0603)size	D22
PS case : 2012-09(0805)Ultra-Low Profile size	D22
PL case : 2012-10(0805)Low Profile size	D22
P case : 2012-12(0805)size	D22
Bottom Surface Electrode(Large Capacitance) : TCTO series	D23,24
U2 case : 1005-064(0402)size	D23
M case : 1608-09(0603)size	D23
PL case : 2012-10(0805)Low Profile size	D23
P case : 2012-12(0805)size	D23
AS case : 3216-10(1206)Ultra-Low Profile size	D24
AL case : 3216-12(1206)Low Profile size	D24
A case : 3216-18(1206)size	D24
BL case : 3528-12(1411)Low Profile size	D24
Standard : TCO series	D25
B case : 3528-21(1411)size	D25

Tantalum Capacitors

New Bottom Surface Electrode(Extra Large Capacitance) : TCS series	D26
M case : 1608-10(0603)size	D26
PS case : 2012-09(0805)Ultra-Low Profile size	D26
P case : 2012-12(0805)size	D26
Bottom Surface Electrode(Large Capacitance) : TCT, TC series	D27,28
U case : 1005-055(0402)size	D27
ML case : 1608-06(0603)Low Profile size	D27
M case : 1608-09(0603)size	D27
PL case : 2012-10(0805)Low Profile size	D28
P case : 2012-12(0805)size	D28
AS case : 3216-10(1206)Ultra-Low Profile size	D28
AL case : 3216-12(1206)Low Profile size	D28
Standard : TC series	D29
P case : 2012-12(0805)size	D29
A case : 3216-18(1206)size	D29
Part Number Explanation	D30
Package Quantity	D30

Contents

Opto Devices

LEDs

SMD LEDs	E2
Quick Reference of Brightness	E2
Characteristics	E5
Part No. Configuration	E9
Dimensions	E10
Through-hole LEDs	E12
Quick Reference of Brightness	E12
Characteristics	E14
Part No. Configuration	E15
Directivity	E16
Dimensions	E16

LED Displays

High Brightness LED Numeric Displays	E18
LED Numeric Displays	E18
Single Digit LED Numeric Displays(Surface Mount type)	E18
Single Digit LED Numeric Displays	E19
Two Digit LED Numeric Displays	E19
Three Digit LED Numeric Displays	E19

Laser Diodes

Red/Infrared Dual Wavelength Lasers	E22
Red Lasers	E22
Infrared Lasers	E23
Part Numbers, Symbols and Definitions	E24
Packaging Specifications	E26

Optical Sensors

Photointerrupter Selection Guide	E28
Transmission type Photointerrupters	E28
Part No. Explanation, Packaging Specifications	E29
Infrared Light Emitting Diodes	E30
Phototransistors	E31
Proximity Sensor	E31
Packages	E32

Modules

Power Supply Modules

Power Supply Module Selection Guide	F2
AC/DC Converters	F3
DC/DC Converters	F4

Wireless Modules

ROHM Wireless Modules Technology	F6
Wi-SUN Communication Modules (Specified Low Power Radio Modules)	F6
Wireless LAN Modules	F6
Bluetooth® Modules	F7
IEEE802.15.4 Communication Module	F7
EnOcean® Communication Modules	F8

Thermal Printheads

Introduction of ROHM Thermal Printheads	F10
Part No. Configuration	F11
For Facsimiles : A series	F12
For Mobile Printers series	F12
For Gaming Equipment, ATMs : CF/CA, CG/LE series	F13
For POS Terminals : DF/DA, DE/KE series	F14
For Ticket, Barcode Label Printers : DC92/DC72, AE series	F15
For Packaging High-speed Printers : AH series	F16

Part No. List

Part No. List	G1
----------------------------	----



ICs

Memory

CONTENTS

SDRAM	P. A3
Standard Legacy DRAM SDRAM(LAPIS Semiconductor products)	P. A3
Industrial Legacy DRAM SDRAM(LAPIS Semiconductor products)	P. A3
Automotive Legacy DRAM SDRAM(LAPIS Semiconductor products)	P. A3
SDRAM for SiP(LAPIS Semiconductor products)	P. A3
Video Memory	P. A4
Video Memory for Standard(LAPIS Semiconductor products)	P. A4
Video Memory for Automotive(LAPIS Semiconductor products)	P. A4
Serial EEPROM	P. A4
Standard EEPROM	P. A4
Automotive EEPROM	P. A6
FeRAM	P. A7
Ferroelectric Memory(LAPIS Semiconductor products)	P. A7

General-purpose ICs

Memory

Memory

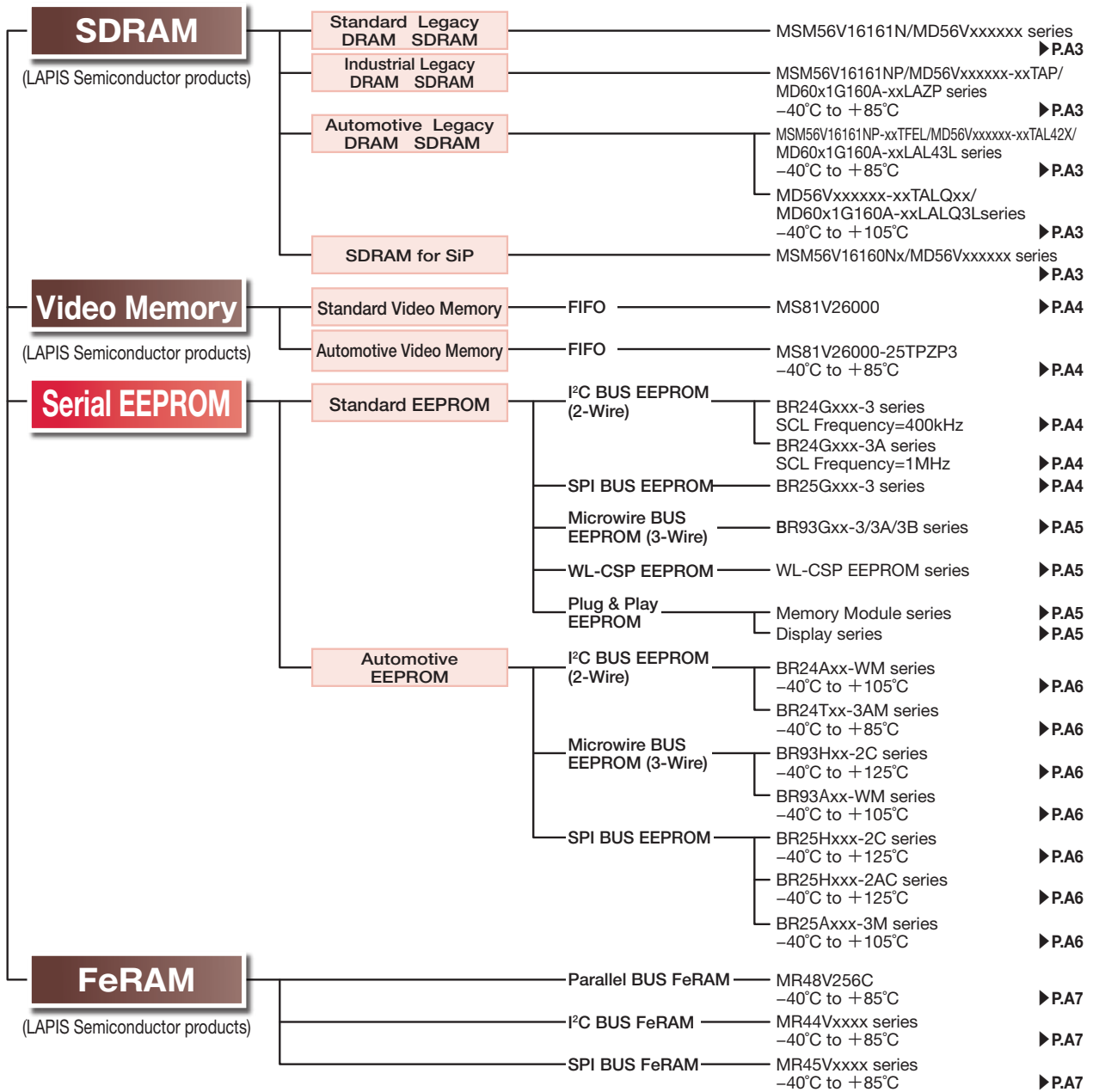

SDRAM

Standard Legacy DRAM SDRAM

(LAPIS Semiconductor products)

Standard												
Part No.	Data Rate Type	Supply Voltage (V)	Density (bit)	Number of Data bits	Configuration (bank×word×bit)	Max. Operating Frequency (MHz)	Refresh Cycle (cycles/ms)	Cycle Time (ns)	Features	Operating Temperature Ta(C)	Package	Halogen Free Support*1
MSM56V16161N	SDR	3.3±0.3	16M	×16	2×512K×16	143	4096/64	7/7.5/10	Drivability Control	0 to +70	TSOP(II)50	✓
MD56V62161M			64M		4×1M×16	143		7/7.5/10			TSOP(II)54	✓
MD56V72161C			128M		4×2M×16	166	6/7/7.5/10	✓				
MD56V82161A			256M		4×4M×16	166	8192/64	6/7/7.5/10				✓

Industrial Legacy DRAM SDRAM

(LAPIS Semiconductor products)

Industrial												
Part No.	Data Rate Type	Supply Voltage (V)	Density (bit)	Number of Data bits	Configuration (bank×word×bit)	Max. Operating Frequency (MHz)	Refresh Cycle (cycles/ms)	Cycle Time (ns)	Features	Operating Temperature Ta(C)	Package	Halogen Free Support*1
MSM56V16161NP	SDR	3.3±0.3	16M	×16	2×512K×16	143	4096/64	7/7.5/10	Drivability Control	-40 to +85	TSOP(II)50	✓
MD56V62161M-xxTAP			64M		4×1M×16	143		7/7.5/10			TSOP(II)54	✓
MD56V72161C-xxTAP			128M		4×2M×16	166	6/7/7.5/10	✓				
MD56V82161A-xxTAP			256M		4×4M×16	166	8192/64	6/7/7.5/10				✓
☆MD60Y1G160A-xxLAZP	DDR3	1.5±0.075	1G	×16	8×8M×16	800 (1600Mbps)	Average refresh period : 7.8µs at Tc≤85°C, 3.9µs at Tc>85°C	1.25/1.5	—	-40 to +95	96-ball FBGA	✓
☆MD60S1G160A-xxLAZP	DDR3L	1.35 +0.1,-0.067	1G	×16	8×8M×16	800 (1600Mbps)	Average refresh period : 7.8µs at Tc≤85°C, 3.9µs at Tc>85°C	1.25/1.5	—	-40 to +95	96-ball FBGA	✓

Automotive Legacy DRAM SDRAM

(LAPIS Semiconductor products)

Automotive(85°C)													
Part No.	Data Rate Type	Supply Voltage (V)	Density (bit)	Number of Data bits	Configuration (bank×word×bit)	Max. Operating Frequency (MHz)	Refresh Cycle (cycles/ms)	Cycle Time (ns)	Features	Operating Temperature Ta(C)	Package	Halogen Free Support*1	Automotive Grade AEC-Q100
MSM56V16161NP-xxTFEL	SDR	3.3±0.3	16M	×16	2×512K×16	143	4096/64	7/7.5/10	Drivability Control	-40 to +85	TSOP(II)50	✓	YES
MD56V62161M-xxTAL42X			64M		4×1M×16	143		7/7.5/10			TSOP(II)54	✓	YES
MD56V72161C-xxTAL42X			128M		4×2M×16	166	6/7/7.5/10	✓				YES	
MD56V82161A-xxTAL42X			256M		4×4M×16	166	8192/64	6/7/7.5/10				✓	YES
☆MD60Y1G160A-xxLAL43L	DDR3	1.5±0.075	1G	×16	8×8M×16	800 (1600Mbps)	Average refresh period : 7.8µs at Tc≤85°C, 3.9µs at Tc>85°C	1.25/1.5	—	-40 to +95	96-ball FBGA	✓	YES
☆MD60S1G160A-xxLAL43L	DDR3L	1.35 +0.1,-0.067	1G	×16	8×8M×16	800 (1600Mbps)	Average refresh period : 7.8µs at Tc≤85°C, 3.9µs at Tc>85°C	1.25/1.5	—	-40 to +95	96-ball FBGA	✓	YES

Automotive(105°C)													
Part No.	Data Rate Type	Supply Voltage (V)	Density (bit)	Number of Data bits	Configuration (bank×word×bit)	Max. Operating Frequency (MHz)	Refresh Cycle (cycles/ms)	Cycle Time (ns)	Features	Operating Temperature Ta(C)	Package	Halogen Free Support*1	Automotive Grade AEC-Q100
MD56V62161M-xxTALQ2X	SDR	3.3±0.3	64M	×16	4×1M×16	143	4096/16	7/7.5/10	Drivability Control	-40 to +105	TSOP(II)54	✓	YES
MD56V72161C-xxTALQ2X			128M		4×2M×16	166		6/7/7.5/10					
MD56V82161A-xxTALQ2X			256M		4×4M×16	166	8192/16	6/7/7.5/10					
☆MD60Y1G160A-xxLALQ3L	DDR3	1.5±0.075	1G	×16	8×8M×16	800 (1600Mbps)	Average refresh period : 7.8µs at Tc≤85°C, 3.9µs at Tc>85°C	1.25/1.5	—	-40 to +105	96-ball FBGA	✓	YES
☆MD60S1G160A-xxLALQ3L	DDR3L	1.35 +0.1,-0.067	1G	×16	8×8M×16	800 (1600Mbps)	Average refresh period : 7.8µs at Tc≤85°C, 3.9µs at Tc>85°C	1.25/1.5	—	-40 to +105	96-ball FBGA	✓	YES

DDR3 : Double Data Rate3 Synchronous DRAM, SDR : Single Data Rate Synchronous DRAM

*1:A check mark of halogen free support means that we will be able to ship out the halogen free products.
 For details, please inquire to the sales.

☆ : Under Development

SDRAM for SiP

(LAPIS Semiconductor products)

Standard										
Part No.	Supply Voltage (V)	Density (bit)	Number of Data bits	Configuration (bank×word×bit)	Max. Operating Frequency (MHz)	Refresh Cycle (cycles/ms)	Cycle Time (ns)	Operating Temperature Tj(C)	Features	
MSM56V16160N	3.3±0.3	16M	×16	2×512K×16	166	4096/32	6/7/7.5/8/10	-40 to +125	KGD	
MD56V62160M		64M		4×1M×16	143		7/7.5/8/10			
MD56V72160C		128M		4×2M×16	166		6/7/7.5/10			

Automotive										
Part No.	Supply Voltage (V)	Density (bit)	Number of Data bits	Configuration (bank×word×bit)	Max. Operating Frequency (MHz)	Refresh Cycle (cycles/ms)	Cycle Time (ns)	Operating Temperature Tj(C)	Features	Automotive Grade*2
MSM56V16160NP	3.3±0.3	16M	×16	2×512K×16	166	4096/16	6/7/7.5/8/10	-40 to +125	KGD	YES
MD56V62160M		64M		4×1M×16	143		7/7.5/8/10			
MD56V72160C		128M		4×2M×16	166		6/7/7.5/10			

*2:Please inquire to the sales for AEC-Q100.

Video Memory

Video Memory for Standard

(LAPIS Semiconductor products)

Standard													
Part No.	Supply Voltage (V)	Density (bit)	Configuration (word × bit) × port	Number of Data bits	Max. Operating Frequency (MHz)	Access Time (ns)	Cycle Time (ns)	Power Consumption(mW)		Operating Temperature Ta(°C)	Package	Notes	Halogen Free Support*1
								Operating	Standby				
MS81V26000	3.3±0.3	26M	1,114,112×24	×24	100	8/9	10/12	648/576	18	0 to +70	TQFP100	Asynchronous serial read/write, Write mask function, Output data control, Cascade, The top address can be specified	✓

Video Memory for Automotive

(LAPIS Semiconductor products)

Automotive														
Part No.	Supply Voltage (V)	Density (bit)	Configuration (word × bit) × port	Number of Data bits	Max. Operating Frequency (MHz)	Access Time (ns)	Cycle Time (ns)	Power Consumption(mW)		Operating Temperature Ta(°C)	Package	Notes	Halogen Free Support*1	Automotive Grade*2
								Operating	Standby					
MS81V26000-25TPZP3	3.3±0.3	26M	1,114,112×24	×24	40	12	25	576	18	-40 to +85	TQFP100	Asynchronous serial read/write, Write mask function, Output data control, Cascade, The top address can be specified	✓	YES

*1:A check mark of halogen free support means that we will be able to ship out the halogen free products.
 For details, please inquire to the sales.

*2:Please inquire to the sales for AEC-Q100.

Serial EEPROM

Standard EEPROM

1 ² C BUS EEPROM (2-Wire) BR24Gxxx-3 series (SCL Frequency = 400kHz)																		
Part No.	Package and Suffix								Density (bit)	Bit Format (word × bit)	Supply Voltage (V)	Current Consumption(Max.)		Write Cycle Time (Max.)(ms)	SCL Frequency (Hz)	Operating Temperature (°C)	Endurance (times)	Data Retention (years)
	SOP8	SOP-J8	SSOP-B8	TSSOP-B8	MSOP8	TSSOP-B8J	VSON008X2030	VMMPO08Z1830				Operating (mA)	Standby (µA)					
BR24G01	F-3	FJ-3	FV-3	FVT-3	FVM-3	FVJ-3	NUX-3	—	1K	128 × 8	1.6 to 5.5	2	2	5	400K	-40 to +85	10 ⁶	40
BR24G02	F-3	FJ-3	FV-3	FVT-3	FVM-3	FVJ-3	NUX-3	—	2K	256 × 8	1.6 to 5.5	2	2	5	400K			
BR24G04	F-3	FJ-3	FV-3	FVT-3	FVM-3	FVJ-3	NUX-3	—	4K	512 × 8	1.6 to 5.5	2	2	5	400K			
BR24G08	F-3	FJ-3	FV-3	FVT-3	FVM-3	FVJ-3	NUX-3	—	8K	1K × 8	1.6 to 5.5	2	2	5	400K			
BR24G16	F-3	FJ-3	FV-3	FVT-3	FVM-3	FVJ-3	NUX-3	QUZ-3	16K	2K × 8	1.6 to 5.5	2	2	5	400K			
BR24G32	F-3	FJ-3	FV-3	FVT-3	FVM-3	FVJ-3	NUX-3	—	32K	4K × 8	1.6 to 5.5	2	2	5	400K			
BR24G64	F-3	FJ-3	FV-3	FVT-3	FVM-3	FVJ-3	NUX-3	—	64K	8K × 8	1.6 to 5.5	2	2	5	400K			
BR24G128	F-3	FJ-3	FV-3	FVT-3	FVM-3	FVJ-3	NUX-3	—	128K	16K × 8	1.6 to 5.5	2.5	2	5	400K			
BR24G256	F-3	FJ-3	FV-3	FVT-3	—	—	—	—	256K	32K × 8	1.6 to 5.5	2.5	2	5	400K			
1 ² C BUS EEPROM (2-Wire) BR24Gxxx-3A series (SCL Frequency = 1MHz)																		
BR24G01	F-3A	FJ-3A	—	FVT-3A	FVM-3A	FVJ-3A	NUX-3A	—	1K	128 × 8	1.7 to 5.5	2	2	5	1M	-40 to +85	10 ⁶	40
BR24G02	F-3A	FJ-3A	—	FVT-3A	FVM-3A	FVJ-3A	NUX-3A	—	2K	256 × 8	1.7 to 5.5	2	2	5	1M			
BR24G04	F-3A	FJ-3A	—	FVT-3A	FVM-3A	FVJ-3A	NUX-3A	—	4K	512 × 8	1.7 to 5.5	2	2	5	1M			
BR24G08	F-3A	FJ-3A	—	FVT-3A	FVM-3A	FVJ-3A	NUX-3A	—	8K	1K × 8	1.7 to 5.5	2	2	5	1M			
BR24G16	F-3A	FJ-3A	—	FVT-3A	FVM-3A	FVJ-3A	NUX-3A	—	16K	2K × 8	1.7 to 5.5	2	2	5	1M			
BR24G32	F-3A	FJ-3A	FV-3A	FVT-3A	FVM-3A	FVJ-3A	NUX-3A	QUZ-3A	32K	4K × 8	1.7 to 5.5	2	2	5	1M			
BR24G64	F-3A	FJ-3A	FV-3A	FVT-3A	FVM-3A	FVJ-3A	NUX-3A	QUZ-3A	64K	8K × 8	1.7 to 5.5	2	2	5	1M			
BR24G128	F-3A	FJ-3A	FV-3A	FVT-3A	FVM-3A	FVJ-3A	NUX-3A	—	128K	16K × 8	1.7 to 5.5	2.5	2	5	1M			
BR24G256	F-3A	FJ-3A	FV-3A	FVT-3A	—	—	—	—	256K	32K × 8	1.7 to 5.5	2.5	2	5	1M			
BR24G512	F-3A	FJ-3A	—	FVT-3A	—	—	—	—	512K	64K × 8	1.7 to 5.5	4.5	3	5	1M			
BR24G1M	F-3A	FJ-3A	—	—	—	—	—	—	1M	128K × 8	1.7 to 5.5	4.5	3	5	1M			
SPI BUS EEPROM BR25Gxxx-3 series																		
Part No.	Package and Suffix					Density (bit)	Bit Format (word × bit)	Supply Voltage (V)	Current Consumption(Max.)		Write Cycle Time (Max.)(ms)	Operating Temperature (°C)	Endurance (times)	Data Retention (years)				
	SOP8	SOP-J8	TSSOP-B8	MSOP8	VSON008X2030				Operating (mA)	Standby (µA)								
BR25G320	F-3	FJ-3	FVT-3	FVM-3	NUX-3	32K	4K × 8	1.6 to 5.5	8	2	5	-40 to +85	10 ⁶	100				
BR25G640	F-3	FJ-3	FVT-3	FVM-3	NUX-3	64K	8K × 8	1.6 to 5.5	8	2	5							
BR25G128	F-3	FJ-3	FVT-3	FVM-3	NUX-3	128K	16K × 8	1.6 to 5.5	8	2	5							
BR25G256	F-3	FJ-3	FVT-3	—	—	256K	32K × 8	1.6 to 5.5	8	2	5							
BR25G512	F-3	FJ-3	FVT-3	—	—	512K	64K × 8	1.8 to 5.5	4	1	5							
BR25G1M	F-3	FJ-3	—	—	—	1M	128K × 8	1.8 to 5.5	4	1	5							

Microwire BUS EEPROM (3-Wire) BR93Gxx-3/3A/3B series														
Part No.	Package and Suffix					Density (bit)	Bit Format (word × bit)	Supply Voltage (V)	Current Consumption(Max.)		Write Cycle Time (Max.)(ms)	Operating Temperature (°C)	Endurance (times)	Data Retention (years)
	SOP8	SOP-J8	TSSOP-B8	MSOP8	VSON008X3020				Operating (mA)	Standby (μA)				
BR93G46	F-3 ^{*1} / F-3A ^{*2} / F-3B ^{*3}	FJ-3 ^{*1} / FJ-3A ^{*2} / FJ-3B ^{*3}	FVT-3 ^{*1} / FVT-3A ^{*2} / FVT-3B ^{*3}	FVM-3 ^{*1} / FVM-3A ^{*2} / FVM-3B ^{*3}	NUX-3 ^{*1} / NUX-3A ^{*2} / NUX-3B ^{*3}	1K	64 × 16 (128 × 8)	1.7 to 5.5	3	2	5	-40 to +85	10 ⁶	40
BR93G56	F-3 ^{*1} / F-3A ^{*2} / F-3B ^{*3}	FJ-3 ^{*1} / FJ-3A ^{*2} / FJ-3B ^{*3}	FVT-3 ^{*1} / FVT-3A ^{*2} / FVT-3B ^{*3}	FVM-3 ^{*1} / FVM-3A ^{*2} / FVM-3B ^{*3}	NUX-3 ^{*1} / NUX-3A ^{*2} / NUX-3B ^{*3}	2K	128 × 16 (256 × 8)	1.7 to 5.5	3	2	5			
BR93G66	F-3 ^{*1} / F-3A ^{*2} / F-3B ^{*3}	FJ-3 ^{*1} / FJ-3A ^{*2} / FJ-3B ^{*3}	FVT-3 ^{*1} / FVT-3A ^{*2} / FVT-3B ^{*3}	FVM-3 ^{*1} / FVM-3A ^{*2} / FVM-3B ^{*3}	NUX-3 ^{*1} / NUX-3A ^{*2} / NUX-3B ^{*3}	4K	256 × 16 (512 × 8)	1.7 to 5.5	3	2	5			
BR93G76	F-3 ^{*1} / F-3A ^{*2} / F-3B ^{*3}	FJ-3 ^{*1} / FJ-3A ^{*2} / FJ-3B ^{*3}	FVT-3 ^{*1} / FVT-3A ^{*2} / FVT-3B ^{*3}	FVM-3 ^{*1} / FVM-3A ^{*2} / FVM-3B ^{*3}	NUX-3 ^{*1} / NUX-3A ^{*2} / NUX-3B ^{*3}	8K	512 × 16 (1K × 8)	1.7 to 5.5	3	2	5			
BR93G86	F-3 ^{*1} / F-3A ^{*2} / F-3B ^{*3}	FJ-3 ^{*1} / FJ-3A ^{*2} / FJ-3B ^{*3}	FVT-3 ^{*1} / FVT-3A ^{*2} / FVT-3B ^{*3}	FVM-3 ^{*1} / FVM-3A ^{*2} / FVM-3B ^{*3}	NUX-3 ^{*1} / NUX-3A ^{*2} / NUX-3B ^{*3}	16K	1K × 16 (2K × 8)	1.7 to 5.5	3	2	5			

Microwire BUS EEPROM (3-Wire) BR93Gxx-3/3A/3B series : *1 : They are dual organization (by 16bit or 8bit) and it is selected the input of ORG PIN. *2 : 1PIN : CS PIN *3 : 3PIN : CS PIN

Micro Wire BUS Pin Assignment

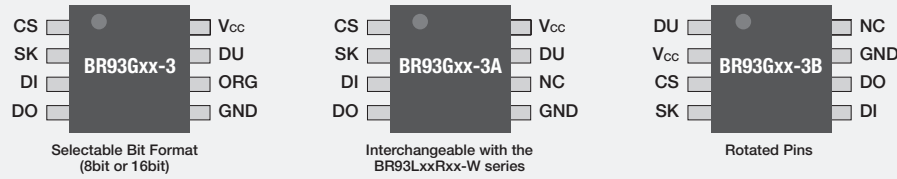

WL-CSP EEPROM

Part No.	I/F	Density (bit)	Package					Pull-up Resistor	Bit Format (word × bit)	Supply Voltage (V)	Current Consumption(Max.)		Write Cycle Time(ms)	Operating Temperature (°C)	Data Retention (years)
			Package Name	Size (mm)	Thickness (mm)Max.	Ball Pitch (mm)	RESIN COATING				Operating (mA)	Standby (μA)			
BU9833GUL-W	I ² C	2K	VCSP50L1	x : 1.27 y : 1.50	0.55	0.5	✓	—	256 × 8	1.7 to 5.5	2	2	5	-40 to +85	40
BU9847GUL-W	I ² C	4K	VCSP50L1	x : 1.95 y : 1.06	0.55	0.5	✓	—	512 × 8	1.7 to 5.5	2	2	5	-40 to +85	40
BU9889GUL-W	I ² C	8K	VCSP50L2	x : 1.60 y : 1.00	0.55	0.5	✓	—	1K × 8	1.7 to 5.5	2	2	5	-40 to +85	40
BRCB008GWZ-3	I ² C	8K	UCSP30L1	x : 0.94 y : 0.94	0.33	0.4	—	—	1K × 8	1.7 to 3.6	2	2	5	-40 to +85	40
BRCB016GWL-3	I ² C	16K	UCSP50L1	x : 1.10 y : 1.15	0.55	0.4	✓	—	2K × 8	1.7 to 3.6	2	2	5	-40 to +85	40
BRCD016GWZ-3	I ² C	16K	UCSP35L1	x : 1.30 y : 0.77	0.40	0.4	✓	—	2K × 8	1.7 to 3.6	2	2	5	-40 to +85	40
New BRCG016GWZ-3	I ² C	16K	UCSP30L1A	x : 0.82 y : 0.82	0.33	0.4	✓	—	2K × 8	1.7 to 5.5	2	2	5	-40 to +85	40
BRCF016GWZ-3	I ² C	16K	UCSP30L1	x : 0.86 y : 0.84	0.35	0.4	—	—	2K × 8	1.7 to 5.5	2	2	5	-40 to +85	40
BRCA016GWZ-W	I ² C	16K	UCSP30L1	x : 1.30 y : 0.77	0.35	0.4	—	—	2K × 8	1.7 to 3.6	2	2	5	-40 to +85	40
BRCB032GWZ-3	I ² C	32K	UCSP30L1	x : 1.45 y : 0.77	0.33	0.4	—	—	4K × 8	1.7 to 5.5	2	2	5	-40 to +85	40
BRCH064GWZ-3	I ² C	64K	UCSP35L1A	x : 1.50 y : 1.00	0.33	0.4	✓	—	8K × 8	1.6 to 5.5	2	2	5	-40 to +85	40
BRCB064GWZ-3	I ² C	64K	UCSP30L1	x : 1.50 y : 1.00	0.35	0.4	—	WP	8K × 8	1.6 to 5.5	3.9	2	5	-40 to +85	40
BRCE064GWZ-3	I ² C	64K	UCSP25L1	x : 1.50 y : 1.00	0.30	0.4	—	—	8K × 8	1.6 to 5.5	2	2	5	-40 to +85	40
BU9897GUL-W	I ² C	128K	VCSP50L2	x : 2.44 y : 1.99	0.55	0.5	✓	—	16K × 8	1.7 to 5.5	2.5	2	5	-40 to +85	40
BU9832GUL-W	SPI	8K	VCSP50L2	x : 2.09 y : 1.85	0.55	0.5	✓	—	1K × 8	1.8 to 5.5	3	2	5	-40 to +85	40
BU9829GUL-W	SPI	16K	VCSP50L1	x : 1.74 y : 1.65	0.55	0.5	✓	—	2K × 8	1.6 to 3.6	2	1	5	-30 to +85	10
BR25S128GUZ-W	SPI	128K	VCSP35L2	x : 2.00 y : 2.63	0.40	0.5	✓	—	16K × 8	1.7 to 5.5	2 [*]	2	5	-40 to +85	40
BU9891GUL-W	MW	4K	VCSP50L1	x : 1.60 y : 1.00	0.55	0.5	✓	—	256 × 16	1.7 to 5.5	3	2	5	-40 to +85	40

WL-CSP EEPROM : * V_{CC}=2.5V

Plug & Play EEPROM For Memory Modules

Part No.	Package and Suffix		Bit Format (word × bit)	Supply Voltage (V)	Clock Frequency (kHz)	Write Cycle Time (ms)	Endurance (times)	Data Retention (years)	Write Protect
	TSSOP-B8	VSON008X2030							
BR34L02	FVT-W	—	256 × 8	1.7 to 5.5	100 ^{*1} /400 ^{*2}	5	10 ⁶	40	Onetime ROM write protect
BR34E02	FVT-3	NUX-3	256 × 8	1.7 to 5.5	400	5	10 ⁶	40	Settable write protect Onetime ROM write protect

Plug & Play EEPROM For Memory Modules : *1 : V_{CC}=1.7 to 5.5V *2 : V_{CC}=2.5 to 5.5V

Plug & Play EEPROM For Display

Part No.	Package and Suffix							Function Descriptions	Bit Format (word × bit)	Supply Voltage (V)	Clock Frequency (MHz)	Write Cycle Time (ms)
	SOP8	SOP-J8	SSOP-B8	SOP14	SSOP-B14	SSOP-B16	VSON008X2030					
BR24C21	F	FJ	FV	—	—	—	—	Supports DDC1™/DDC2™ for displays	128 × 8	2.5 to 5.5	100/400	10
BU9882	—	—	—	F-W	FV-W	—	—	Dual-port type compatible with DDC2™ for displays	128 × 8 × 2ch	2.5 to 5.5	100/400	10
BU9883	—	—	—	—	—	FV-W	—	2kbit × 3ch EEPROM for HDMI ports	256 × 8 × 3ch	3.0 to 5.5	400	5
BU99022	—	—	—	—	—	—	NUX-3	2kbit × 2ch type	256 × 8 × 2ch	1.7 to 5.5	400	5

DDC is a trademark of Video Electronics Standards Association.

Automotive EEPROM
A
Memory
105°C Operation I²C BUS EEPROM (2-Wire) BR24Axx-WM series

Part No.	Package and Suffix			Density (bit)	Bit Format (word × bit)	Supply Voltage (V)	Current Consumption(Max.)		Write Cycle Time (Max.)(ms)	Operating Temperature (°C)	Endurance (times)	Data Retention (years)	Automotive Grade AEC-Q100
	SOP8	SOP-J8	MSOP8				Operating (mA)	Standby (µA)					
BR24A01A	F-WM	FJ-WM	—	1K	128 × 8	2.5 to 5.5	2	2	5	-40 to +105	10 ⁶	40	YES
BR24A02	F-WM	FJ-WM	FVM-WM	2K	256 × 8	2.5 to 5.5	2	2	5				
BR24A04	F-WM	FJ-WM	—	4K	512 × 8	2.5 to 5.5	2	2	5				
BR24A08	F-WM	FJ-WM	—	8K	1K × 8	2.5 to 5.5	2	2	5				
BR24A16	F-WM	FJ-WM	—	16K	2K × 8	2.5 to 5.5	2	2	5				
BR24A32	F-WM	—	—	32K	4K × 8	2.5 to 5.5	3	2	5				
BR24A64	F-WM	—	—	64K	8K × 8	2.5 to 5.5	3	2	5				

85°C Operation Microwire I²C BUS EEPROM (2-Wire) BR24Txx-3AM series

Part No.	Package and Suffix			Density (bit)	Bit Format (word × bit)	Supply Voltage (V)	Current Consumption(Max.)		Write Cycle Time (Max.)(ms)	Operating Temperature (°C)	Endurance (times)	Data Retention (years)	Automotive Grade AEC-Q100
	SOP8	SOP-J8	TSSOP-B8				Operating (mA)	Standby (µA)					
New BR24T512	F-3AM	FJ-3AM	FVT-3AM	512K	64K × 8	1.7 to 5.5	4.5	3	5	-40 to +85	10 ⁶	40	YES
New BR24T1M	F-3AM	FJ-3AM	—	1M	128K × 8	1.7 to 5.5	4.5	3	5				

125°C Operation Microwire BUS EEPROM (3-Wire) BR93Hxx-2C series

Part No.	Package and Suffix				Density (bit)	Bit Format (word × bit)	Supply Voltage (V)	Current Consumption(Max.)		Write Cycle Time (Max.)(ms)	Operating Temperature (°C)	Endurance (times)	Data Retention (years)	Automotive Grade AEC-Q100
	SOP8	SOP-J8	TSSOP-B8	MSOP8				Operating (mA)	Standby (µA)					
BR93H46	RF-2C	RFJ-2C	RFVT-2C	RFVM-2C	1K	64 × 16	2.5 to 5.5	3	10	4	-40 to +125	10 ⁶	100	YES
BR93H56	RF-2C	RFJ-2C	RFVT-2C	RFVM-2C	2K	128 × 16	2.5 to 5.5	3	10	4				
BR93H66	RF-2C	RFJ-2C	RFVT-2C	RFVM-2C	4K	256 × 16	2.5 to 5.5	3	10	4				
BR93H76	RF-2C	RFJ-2C	RFVT-2C	RFVM-2C	8K	512 × 16	2.5 to 5.5	3	10	4				
BR93H86	RF-2C	RFJ-2C	RFVT-2C	RFVM-2C	16K	1K × 16	2.5 to 5.5	3	10	4				

105°C Operation Microwire BUS EEPROM (3-Wire) BR93Axx-WM series

BR93A46	RF-WM	RFJ-WM	RFVT-WM	RFVM-WM	1K	64 × 16	2.5 to 5.5	3	2	5	-40 to +105	10 ⁶	40	YES
BR93A56	RF-WM	RFJ-WM	RFVT-WM	RFVM-WM	2K	128 × 16	2.5 to 5.5	3	2	5				
BR93A66	RF-WM	RFJ-WM	RFVT-WM	RFVM-WM	4K	256 × 16	2.5 to 5.5	3	2	5				
BR93A76	RF-WM	RFJ-WM	RFVT-WM	RFVM-WM	8K	512 × 16	2.5 to 5.5	3	2	5				
BR93A86	RF-WM	RFJ-WM	RFVT-WM	RFVM-WM	16K	1K × 16	2.5 to 5.5	3	2	5				

125°C Operation SPI BUS EEPROM BR25Hxxx-2C series

BR25H010	F-2C	FJ-2C	FVT-2C	FVM-2C	1K	128 × 8	2.5 to 5.5	4	10	4	-40 to +125	10 ⁶	100	YES
BR25H020	F-2C	FJ-2C	FVT-2C	FVM-2C	2K	256 × 8	2.5 to 5.5	4	10	4				
BR25H040	F-2C	FJ-2C	FVT-2C	FVM-2C	4K	512 × 8	2.5 to 5.5	4	10	4				
BR25H080	F-2C	FJ-2C	FVT-2C	FVM-2C	8K	1K × 8	2.5 to 5.5	4	10	4				
BR25H160	F-2C	FJ-2C	FVT-2C	FVM-2C	16K	2K × 8	2.5 to 5.5	4	10	4				
BR25H320	F-2C	FJ-2C	FVT-2C	FVM-2C	32K	4K × 8	2.5 to 5.5	4	10	4				
BR25H640	F-2C	FJ-2C	FVT-2C	—	64K	8K × 8	2.5 to 5.5	5.5	10	4				
BR25H128	F-2C	FJ-2C	—	—	128K	16K × 8	2.5 to 5.5	5.5	10	4				

125°C Operation SPI BUS EEPROM with ECC Function BR25Hxxx-2AC series

BR25H640	F-2AC	FJ-2AC	FVT-2AC	FVM-2AC	64K	8K × 8	2.5 to 5.5	5.5	10	4	-40 to +125	10 ⁶	100	YES
BR25H128	F-2AC	FJ-2AC	FVT-2AC	—	128K	16K × 8	2.5 to 5.5	5.5	10	4				
BR25H256	F-2AC	FJ-2AC	—	—	256K	32K × 8	2.5 to 5.5	5.5	10	4				

105°C Operation SPI BUS EEPROM BR25Axxx-3M series

BR25A256	F-3M	FJ-3M	FVT-3M	—	256K	32K × 8	2.5 to 5.5	4	10	5	-40 to +105	10 ⁶	100	YES
BR25A512	F-3M	FJ-3M	FVT-3M	—	512K	64K × 8	2.5 to 5.5	4	10	5				
BR25A1M	F-3M	FJ-3M	—	—	1M	128K × 8	2.5 to 5.5	4	10	5				

FeRAM

Ferroelectric Memory

(LAPIS Semiconductor products)

A

Memory

Parallel BUS FeRAM										
Part No.	Memory Density (bit)	Configuration (word×bit)	Supply Voltage (V)	Operating Speed	Read/Write Endurance (times)	Data Retention (years)	Operating Temperature Ta(°C)	Package	Halogen Free Support*1	Automotive Grade*2
MR48V256C	256K	32K×8	2.7 to 3.6	t _{RC} =150ns	10 ¹²	10	-40 to +85	TSOP(I)28	—	YES
I ² C BUS FeRAM MR44Vxxxx series										
MR44V064A	64K	8K×8	2.5 to 3.6	f _{clk} =3.4MHz	10 ¹²	10	-40 to +85	SOP8	✓	YES
MR44V064B	64K	8K×8	1.8 to 3.6	f _{clk} =3.4MHz					✓	
New MR44V100A	1M	128K×8	1.8 to 3.6	f _{clk} =3.4MHz					✓	
SPI BUS FeRAM MR45Vxxxx series										
MR45V032A	32K	4K×8	2.7 to 3.6	f _{clk} =15MHz	10 ¹²	10	-40 to +85	SOP8	✓	YES
MR45V064B	64K	8K×8	1.8 to 3.6	f _{clk} =40MHz					✓	
MR45V256A	256K	32K×8	3.0 to 3.6	f _{clk} =15MHz					✓	
New MR45V100A	1M	128K×8	1.8 to 3.6	f _{clk} =40MHz				✓	—	
MR45V200A	2M	256K×8	2.7 to 3.6	f _{clk} =34MHz				✓	—	

*1:A check mark of halogen free support means that we will be able to ship out the halogen free products.
For details, please inquire to the sales.

*2:Please inquire to the sales for AEC-Q100.



ICs

Amplifiers & Linear

CONTENTS

Operational Amplifiers	P. A10
Standard	P. A10
High Speed	P. A11
Low Power Consumption	P. A13
Low Noise	P. A15
Low Offset Voltage	P. A16
Comparators	P. A16
Standard	P. A16
High Speed	P. A17
Low Power Consumption	P. A17
Transistor Arrays	P. A18
Darlington Transistor Arrays	P. A18

General-purpose ICs

Operational Amplifiers/Comparators

A
Amplifiers & Linear

Operational Amplifiers/Comparators

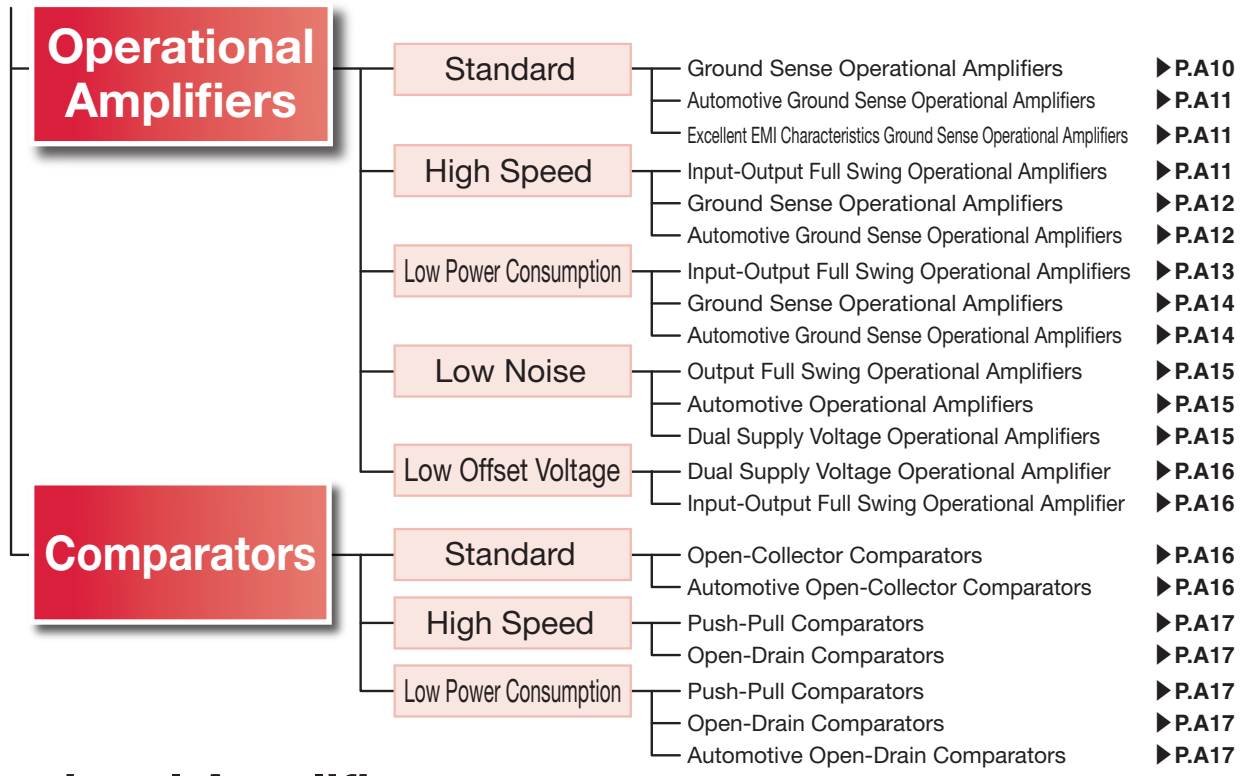

Operational Amplifiers

Standard

Ground Sense Operational Amplifiers																
Part No.	Product Grade	CH	Supply Voltage (V)	Circuit Current (mA)	Input Offset Voltage (mV)	Input Bias Current (nA)	Output Current (mA)	Input Voltage Range (V)	Output Voltage Range (V)	Voltage Gain (dB)	CMRR (dB)	PSRR (dB)	Slew Rate (V/μs)	Gain Bandwidth Product (MHz)	Operating Temperature (°C)	Package
BA2904F	○															SOP8
BA2904FV	○	2	3 to 36	0.5	2.0	20	30	V _{EE} to V _{CC} -1.5	V _{EE} to V _{CC} -1.5	100	80	100	0.2	0.5	-40 to +125	SSOP-B8
BA2904FVM	○															MSOP8
BA2904SF	○															SOP8
BA2904SFV	○	2	3 to 36	0.5	2.0	20	30	V _{EE} to V _{CC} -1.5	V _{EE} to V _{CC} -1.5	100	80	100	0.2	0.5	-40 to +105	SSOP-B8
BA2904SFVM	○															MSOP8
BA2904YF-LB	○	2	3 to 36	0.5	2.0	20	30	V _{EE} to V _{CC} -1.5	V _{EE} to V _{CC} -1.5	100	80	100	0.2	0.5	-40 to +125	SOP8
BA2902F	○															SOP14
BA2902FV	○	4	3 to 36	0.7	2.0	20	30	V _{EE} to V _{CC} -1.5	V _{EE} to V _{CC} -1.5	100	80	100	0.2	0.5	-40 to +125	SSOP-B14
BA2902SF	○															SOP14
BA2902SFV	○	4	3 to 36	0.7	2.0	20	30	V _{EE} to V _{CC} -1.5	V _{EE} to V _{CC} -1.5	100	80	100	0.2	0.5	-40 to +105	SSOP-B14
BA2902YF-LB	○	4	3 to 36	0.7	2.0	20	30	V _{EE} to V _{CC} -1.5	V _{EE} to V _{CC} -1.5	100	80	100	0.2	0.5	-40 to +125	SOP14
BA3404F	—															SOP8
BA3404FJ	—	2	4 to 36	2.0	2.0	70	30	V _{EE} to V _{CC} -2.0	V _{EE} to V _{CC} -2.0	100	90	94	1.2	1.2	-40 to +85	SOP-J8
BA3404FVM	—															MSOP8
New LM2902F	○															SOP14
New LM2902FJ	○															SOP-J14
New LM2902FV	○	4	3 to 32	1,000	1.0	20	30	V _{EE} to V _{CC} -1.5	V _{EE} to V _{CC} -1.5	100	80	100	0.3	0.8	-40 to +125	SSOP-B14
New LM2902FVJ	○															TSSOP-B14J
LM2904F	○															SOP8
LM2904FJ	○															SOP-J8
LM2904FV	○	2	3 to 32	600	1.0	20	30	V _{EE} to V _{CC} -1.5	V _{EE} to V _{CC} -1.5	100	80	100	0.3	0.8	-40 to +125	SSOP-B8
LM2904FVJ	○															TSSOP-B8J
New LM2904FVM	○															MSOP8
LM2904FVT	○															TSSOP-B8

Product Grade : —Standard ○High Grade

Automotive Ground Sense Operational Amplifiers																	
Part No.	Product Grade	CH	Supply Voltage (V)	Circuit Current (mA)	Input Offset Voltage (mV)	Input Bias Current (nA)	Output Current (mA)	Input Voltage Range (V)	Output Voltage Range (V)	Voltage Gain (dB)	CMRR (dB)	PSRR (dB)	Slew Rate (V/ μ s)	Gain Bandwidth Product (MHz)	Operating Temperature (°C)	Package	Automotive Grade AEC-Q100
BA2904YF-C	●	2	3 to 36	0.5	2.0	20	30	V _{EE} to V _{CC} -1.5	V _{EE} to V _{CC} -1.5	100	80	100	0.2	0.5	-40 to +125	SOP8	YES
BA2904YFV-C	●															SSOP-B8	YES
BA2904YFVM-C	●	4	3 to 36	0.7	2.0	20	30	V _{EE} to V _{CC} -1.5	V _{EE} to V _{CC} -1.5	100	80	100	0.2	0.5	-40 to +125	MSOP8	YES
BA2902YF-C	●															SOP14	YES
BA2902YFV-C	●	2	3 to 36	0.5	2.0	20	30	V _{EE} to V _{CC} -1.5	V _{EE} to V _{CC} -1.5	100	80	100	0.2	0.5	-40 to +125	SSOP-B14	YES
BA2904YF-M	●															SOP8	YES
BA2904YFV-M	●	4	3 to 36	0.7	2.0	20	30	V _{EE} to V _{CC} -1.5	V _{EE} to V _{CC} -1.5	100	80	100	0.2	0.5	-40 to +125	SSOP-B8	YES
BA2904YFVM-M	●															MSOP8	YES
BA2902YF-M	●	2	3 to 36	0.5	2.0	20	30	V _{EE} to V _{CC} -1.5	V _{EE} to V _{CC} -1.5	100	80	100	0.2	0.5	-40 to +125	SOP14	YES
BA2902YFV-M	●															SSOP-B14	YES

Excellent EMI Characteristics Ground Sense Operational Amplifiers																		
New	BA82904YF-C	●	2	3 to 36	0.5	2.0	20	30	V _{EE} to V _{CC} -1.5	V _{EE} to V _{CC} -1.5	100	80	100	0.2	0.5	-40 to +125	SOP8	YES
New	BA82904YFVM-C	●															MSOP8	YES
New	BA82902YF-C	●	4	3 to 36	0.7	2.0	20	30	V _{EE} to V _{CC} -1.5	V _{EE} to V _{CC} -1.5	100	80	100	0.2	0.5	-40 to +125	SOP14	YES
New	BA82902YFV-C	●															SSOP-B14	YES

Product Grade : ●Automotive Grade

High Speed

Input-Output Full Swing Operational Amplifiers																	
Part No.	Product Grade	CH	Supply Voltage (V)	Circuit Current (mA)	Input Offset Voltage (mV)	Input Bias Current (nA)	Output Current (mA)	Input Voltage Range (V)	Output Voltage Range (V)	Voltage Gain (dB)	CMRR (dB)	PSRR (dB)	Slew Rate (V/ μ s)	Gain Bandwidth Product (MHz)	Operating Temperature (°C)	Package	
BU7261G	—	1	1.8 to 5.5	250	1.0	0.001	10	V _{SS} to V _{DD}	V _{SS} +0.1 to V _{DD} -0.1	95	60	80	1.1	2.0	-40 to +85	SSOP5	
BU7261SG	○														-40 to +105	SSOP5	
BU7262F	—	2	1.8 to 5.5	550	1.0	0.001	10	V _{SS} to V _{DD}	V _{SS} +0.1 to V _{DD} -0.1	95	60	80	1.1	2.0	-40 to +85	SOP8	
BU7262FVM	—														MSOP8		
BU7262NUX	—	2	1.8 to 5.5	550	1.0	0.001	10	V _{SS} to V _{DD}	V _{SS} +0.1 to V _{DD} -0.1	95	60	80	1.1	2.0	-40 to +105	VSON008X2030	
BU7262SF	○														SOP8		
BU7262SFVM	○	4	1.8 to 5.5	1,100	1.0	0.001	10	V _{SS} to V _{DD}	V _{SS} +0.1 to V _{DD} -0.1	95	60	80	1.1	2.0	-40 to +85	SSOP-B14	
BU7262SNUX	○														VSON008X2030		
BU7264F	—	4	1.8 to 5.5	1,100	1.0	0.001	10	V _{SS} to V _{DD}	V _{SS} +0.1 to V _{DD} -0.1	95	60	80	1.1	2.0	-40 to +85	SOP14	
BU7264FV	—														SSOP-B14		
BU7264SF	○	1	2.4 to 5.5	470	1.0	0.001	8	V _{SS} to V _{DD}	V _{SS} +0.1 to V _{DD} -0.1	105	60	80	3.0	2.8	-40 to +105	SOP14	
BU7264SFV	○														SSOP-B14		
BU7291G	—	4	2.4 to 5.5	2,000	1.0	0.001	8	V _{SS} to V _{DD}	V _{SS} +0.1 to V _{DD} -0.1	105	60	80	3.0	2.8	-40 to +85	SOP14	
BU7291SG	○														SSOP-B14		
BU7294F	—	1	1.8 to 5.5	150	1.0	0.001	8	V _{SS} to V _{DD}	V _{SS} +0.1 to V _{DD} -0.1	95	60	80	1.0	1.0	-40 to +105	SOP14	
BU7294FV	—														HVSO5		
BU7294SF	○	1	2.4 to 5.5	540	1.0	0.001	4	V _{SS} to V _{DD}	V _{SS} +0.1 to V _{DD} -0.1	105	60	80	3.4	4.0	-40 to +85	SOP14	
BU7294SFV	○														HVSO5		
BU7295HFV	—	1	5.0 to 14.5	440	1.0	0.001	8	V _{SS} to V _{DD}	V _{SS} +0.1 to V _{DD} -0.1	95	60	80	0.9	1.0	-40 to +105	SOP14	
BU7295SHFV	○														SSOP-B14		
BU7255HFV	—	2	5.0 to 14.5	900	1.0	0.001	8	V _{SS} to V _{DD}	V _{SS} +0.1 to V _{DD} -0.1	95	60	80	0.9	1.0	-40 to +85	SOP8	
BU7255SHFV	○														MSOP8		
BD7561G	—	2	5.0 to 14.5	900	1.0	0.001	8	V _{SS} to V _{DD}	V _{SS} +0.1 to V _{DD} -0.1	95	60	80	0.9	1.0	-40 to +105	SOP8	
BD7561SG	○														MSOP8		
BD7562F	—	1	5.0 to 14.5	440	1.0	0.001	8	V _{SS} to V _{DD}	V _{SS} +0.1 to V _{DD} -0.1	95	60	80	0.9	1.0	-40 to +85	SOP8	
BD7562FVM	—														MSOP8		
BD7562SF	○	1	5.0 to 14.5	440	1.0	0.001	8	V _{SS} to V _{DD}	V _{SS} +0.1 to V _{DD} -0.1	95	60	80	0.9	1.0	-40 to +105	SOP8	
BD7562SFVM	○														MSOP8		

Product Grade : —Standard ○High Grade

High Speed
A Amplifiers & Linear

Ground Sense Operational Amplifiers																
Part No.	Product Grade	CH	Supply Voltage (V)	Circuit Current (mA)	Input Offset Voltage (mV)	Input Bias Current (nA)	Output Current (mA)	Input Voltage Range (V)	Output Voltage Range (V)	Voltage Gain (dB)	CMRR (dB)	PSRR (dB)	Slew Rate (V/μs)	Gain Bandwidth Product (MHz)	Operating Temperature (°C)	Package
BA3472F	—	—	—	—	—	—	—	—	—	—	—	—	—	—	—	SOP8
BA3472FV	—	—	—	—	—	—	—	—	—	—	—	—	—	—	—	SSOP-B8
BA3472FJ	—	—	—	—	—	—	—	—	—	—	—	—	—	—	—40 to +85	SOP-J8
BA3472FVM	—	2	3 to 36	4.0	1.0	100	30	V _{EE} to V _{CC} -2.0	V _{EE} +0.3 to V _{CC} -1.0	100	97	97	10.0	4.0	—40 to +85	MSOP8
BA3472FVT	—	—	—	—	—	—	—	—	—	—	—	—	—	—	—40 to +85	TSSOP-B8
BA3472YF-LB	○	—	—	—	—	—	—	—	—	—	—	—	—	—	-40 to +125	SOP8
BA3472RFVM	○	—	—	—	—	—	—	—	—	—	—	—	—	—	-40 to +105	MSOP8
BA3474F	—	—	—	—	—	—	—	—	—	—	—	—	—	—	-40 to +75	SOP14
BA3474FV	—	—	—	—	—	—	—	—	—	—	—	—	—	—	-40 to +85	SSOP-B14
BA3474FVJ	—	4	3 to 36	8.0	1.0	100	30	V _{EE} to V _{CC} -2.0	V _{EE} +0.3 to V _{CC} -1.0	100	97	97	10.0	4.0	-40 to +85	TSSOP-B14J
BA3474RFV	○	—	—	—	—	—	—	—	—	—	—	—	—	—	-40 to +105	SSOP-B14
BU7461G	—	—	—	—	—	—	—	—	—	—	—	—	—	—	-40 to +85	SSOP5
BU7461SG	○	1	1.7 to 5.5	0.15	1.0	0.001	8	V _{SS} to V _{DD} -1.2	V _{SS} +0.1 to V _{DD} -0.1	95	60	80	1.0	1.0	-40 to +105	SSOP5
BU7462F	—	—	—	—	—	—	—	—	—	—	—	—	—	—	—	SOP8
BU7462FVM	—	2	1.7 to 5.5	0.3	1.0	0.001	8	V _{SS} to V _{DD} -1.2	V _{SS} +0.1 to V _{DD} -0.1	95	60	80	1.0	1.0	-40 to +85	MSOP8
BU7462NUX	—	—	—	—	—	—	—	—	—	—	—	—	—	—	—	VSON008X2030
BU7462SF	○	—	—	—	—	—	—	—	—	—	—	—	—	—	—	SOP8
BU7462SFVM	○	2	1.7 to 5.5	0.3	1.0	0.001	8	V _{SS} to V _{DD} -1.2	V _{SS} +0.1 to V _{DD} -0.1	95	60	80	1.0	1.0	-40 to +105	MSOP8
BU7462SNUX	○	—	—	—	—	—	—	—	—	—	—	—	—	—	—	VSON008X2030
BU7464F	—	—	—	—	—	—	—	—	—	—	—	—	—	—	-40 to +85	SOP14
BU7464SF	○	4	1.7 to 5.5	0.6	1.0	0.001	8	V _{SS} to V _{DD} -1.2	V _{SS} +0.1 to V _{DD} -0.1	95	60	80	1.0	1.0	-40 to +105	SOP14
BU7465HFV	—	—	—	—	—	—	—	—	—	—	—	—	—	—	-40 to +85	HVSOF5
BU7465SHFV	○	1	1.7 to 5.5	0.12	1.0	0.001	8	V _{SS} to V _{DD} -1.2	V _{SS} +0.1 to V _{DD} -0.1	100	60	80	1.0	1.2	-40 to +105	HVSOF5
BU7481G	—	—	—	—	—	—	—	—	—	—	—	—	—	—	-40 to +85	SSOP5
BU7481SG	○	1	1.8 to 5.5	0.42	1.0	0.001	8	V _{SS} to V _{DD} -1.2	V _{SS} +0.1 to V _{DD} -0.1	105	60	80	3.2	2.8	-40 to +105	SSOP5
BU7485G	—	—	—	—	—	—	—	—	—	—	—	—	—	—	-40 to +85	SSOP5
BU7485SG	○	1	3.0 to 5.5	1.5	1.0	0.001	8	V _{SS} to V _{DD} -1.4	V _{SS} +0.1 to V _{DD} -0.1	105	60	80	10.0	10.0	-40 to +105	SSOP5
BU7486F	—	—	—	—	—	—	—	—	—	—	—	—	—	—	—	SOP8
BU7486FV	—	—	—	—	—	—	—	—	—	—	—	—	—	—	-40 to +85	SSOP-B8
BU7486FVM	—	—	—	—	—	—	—	—	—	—	—	—	—	—	—	MSOP8
BU7486SF	○	2	3.0 to 5.5	3.0	1.0	0.001	8	V _{SS} to V _{DD} -1.4	V _{SS} +0.1 to V _{DD} -0.1	105	60	80	10.0	10.0	—	SOP8
BU7486SFV	○	—	—	—	—	—	—	—	—	—	—	—	—	—	-40 to +105	SSOP-B8
BU7486SFVM	○	—	—	—	—	—	—	—	—	—	—	—	—	—	—	MSOP8
BU7487F	—	—	—	—	—	—	—	—	—	—	—	—	—	—	-40 to +85	SOP14
BU7487FV	—	—	—	—	—	—	—	—	—	—	—	—	—	—	-40 to +85	SSOP-B14
BU7487SF	○	4	3.0 to 5.5	6.0	1.0	0.001	8	V _{SS} to V _{DD} -1.4	V _{SS} +0.1 to V _{DD} -0.1	105	60	80	10.0	10.0	-40 to +105	SOP14
BU7487SFV	○	—	—	—	—	—	—	—	—	—	—	—	—	—	-40 to +105	SSOP-B14
BU7495HFV	—	—	—	—	—	—	—	—	—	—	—	—	—	—	-40 to +85	HVSOF5
BU7495SHFV	○	1	1.8 to 5.5	0.65	1.0	0.001	7	V _{SS} to V _{DD} -1.2	V _{SS} +0.1 to V _{DD} -0.1	100	60	80	5.0	4.0	-40 to +105	HVSOF5

Automotive Ground Sense Operational Amplifiers

Part No.	Product Grade	CH	Supply Voltage (V)	Circuit Current (mA)	Input Offset Voltage (mV)	Input Bias Current (nA)	Output Current (mA)	Input Voltage Range (V)	Output Voltage Range (V)	Voltage Gain (dB)	CMRR (dB)	PSRR (dB)	Slew Rate (V/μs)	Gain Bandwidth Product (MHz)	Operating Temperature (°C)	Package	Automotive Grade AEC-Q100
BA3472YF-C	●	—	—	—	—	—	—	—	—	—	—	—	—	—	—	SOP8	YES
BA3472YFV-C	●	—	—	—	—	—	—	—	—	—	—	—	—	—	—	SSOP-B8	YES
BA3472YFVM-C	●	2	3 to 36	4.0	1.0	100	30	V _{EE} to V _{CC} -2.0	V _{EE} +0.3 to V _{CC} -1.0	100	97	97	10	4.0	-40 to +125	MSOP8	YES
BA3472WFV-C	●	—	—	—	—	—	—	—	—	—	—	—	—	—	—	SSOP-B8	YES
BA3474WFV-C	●	—	—	—	—	—	—	—	—	—	—	—	—	—	-40 to +125	SSOP-B14	YES
BA3474YFV-C	●	4	3 to 36	8.0	1.0	100	30	V _{EE} to V _{CC} -2.0	V _{EE} +0.3 to V _{CC} -1.0	100	97	97	10	4.0	-40 to +125	SSOP-B14	YES

Product Grade : — Standard ○ High Grade ● Automotive Grade

Low Power Consumption

Input-Output Full Swing Operational Amplifiers																
Part No.	Product Grade	CH	Supply Voltage (V)	Circuit Current (μA)	Input Offset Voltage (mV)	Input Bias Current (nA)	Output Current (mA)	Input Voltage Range (V)	Output Voltage Range (V)	Voltage Gain (dB)	CMRR (dB)	PSRR (dB)	Slew Rate (V/μs)	Gain Bandwidth Product (MHz)	Operating Temperature (°C)	Package
BU7205HFV	—	1	1.8 to 5.5	0.4	1.0	0.001	1.2	V _{SS} to V _{DD}	V _{SS} +0.1 to V _{DD} -0.1	95	60	80	0.0025	0.0025	-40 to +85	HVSOF5
BU7205SHFV	○														-40 to +105	HVSOF5
BU7241G	—	1	1.8 to 5.5	70	1.0	0.001	10	V _{SS} to V _{DD}	V _{SS} +0.1 to V _{DD} -0.1	95	60	80	0.4	0.9	-40 to +85	SSOP5
BU7241SG	○														-40 to +105	SSOP5
BU7242F	—	2	1.8 to 5.5	180	1.0	0.001	10	V _{SS} to V _{DD}	V _{SS} +0.1 to V _{DD} -0.1	95	60	80	0.4	0.9	-40 to +85	SOP8
BU7242FVM	—														MSOP8	
BU7242NUX	—															VSON008X2030
BU7242SF	○	2	1.8 to 5.5	180	1.0	0.001	10	V _{SS} to V _{DD}	V _{SS} +0.1 to V _{DD} -0.1	95	60	80	0.4	0.9	-40 to +105	SOP8
BU7242SFVM	○														MSOP8	
BU7242SNUX	○															VSON008X2030
BU7244F	—	4	1.8 to 5.5	360	1.0	0.001	10	V _{SS} to V _{DD}	V _{SS} +0.1 to V _{DD} -0.1	95	60	80	0.4	0.9	-40 to +85	SOP14
BU7244FV	—														SSOP-B14	
BU7244SF	○														-40 to +105	SOP14
BU7244SFV	○														SSOP-B14	
BU7245HFV	—	1	1.8 to 5.5	5	1.0	0.001	4	V _{SS} to V _{DD}	V _{SS} +0.1 to V _{DD} -0.1	95	60	80	0.035	0.09	-40 to +85	HVSOF5
BU7245SHFV	○														-40 to +105	HVSOF5
BU7265G	—	1	1.8 to 5.5	0.35	1.0	0.001	2.4	V _{SS} to V _{DD}	V _{SS} +0.1 to V _{DD} -0.1	95	60	80	0.0024	0.004	-40 to +85	SSOP5
BU7265SG	○														-40 to +105	SSOP5
BU7266F	—	2	1.8 to 5.5	0.7	1.0	0.001	2.4	V _{SS} to V _{DD}	V _{SS} +0.1 to V _{DD} -0.1	95	60	80	0.0024	0.004	-40 to +85	SOP8
BU7266FV	—														SSOP-B8	
BU7266FVM	—															MSOP8
BU7266SF	○	2	1.8 to 5.5	0.7	1.0	0.001	2.4	V _{SS} to V _{DD}	V _{SS} +0.1 to V _{DD} -0.1	95	60	80	0.0024	0.004	-40 to +105	SOP8
BU7266SFV	○														SSOP-B8	
BU7266SFVM	○															MSOP8
BU7271G	—	1	1.8 to 5.5	8.6	1.0	0.001	4	V _{SS} to V _{DD}	V _{SS} +0.1 to V _{DD} -0.1	100	60	80	0.05	0.09	-40 to +85	SSOP5
BU7271SG	○														-40 to +105	SSOP5
BU7275HFV	—	1	1.8 to 5.5	40	1.0	0.001	8	V _{SS} to V _{DD}	V _{SS} +0.1 to V _{DD} -0.1	95	60	80	0.3	0.6	-40 to +85	HVSOF5
BU7275SHFV	○														-40 to +105	HVSOF5
BD12730G	—	1	1.8 to 5.5	320	1.0	50	5	GND to V ₊	0.1 to V ₊ -0.1	85	70	85	0.4	1.0	-40 to +85	SSOP5
BD12732F	—	2	1.8 to 5.5	580	1.0	50	5	GND to V ₊	0.1 to V ₊ -0.1	85	70	85	0.4	1.0	-40 to +85	SOP8
BD12732FJ	—														SOP-J8	
BD12732FV	—														SSOP-B8	
BD12732FVJ	—														TSSOP-B8J	
BD12732FVM	—														MSOP8	
BD12732FVT	—														TSSOP-B8	
BD12734F	—	4	1.8 to 5.5	1,200	1.0	50	5	GND to V ₊	0.1 to V ₊ -0.1	85	70	85	0.4	1.0	-40 to +85	SOP14
BD12734FJ	—														SOP-J14	
BD12734FV	—														SSOP-B14	
BD12734FVJ	—														TSSOP-B14J	
BD7541G	—	1	5.0 to 14.5	180	1.0	0.001	4	V _{SS} to V _{DD}	V _{SS} +0.1 to V _{DD} -0.1	95	60	80	0.3	0.6	-40 to +85	SSOP5
BD7541SG	○														-40 to +105	SSOP5
BD7542F	—	2	5.0 to 14.5	400	1.0	0.001	4	V _{SS} to V _{DD}	V _{SS} +0.1 to V _{DD} -0.1	95	60	80	0.3	0.6	-40 to +85	SOP8
BD7542FVM	—														MSOP8	
BD7542SF	○	2	5.0 to 14.5	400	1.0	0.001	4	V _{SS} to V _{DD}	V _{SS} +0.1 to V _{DD} -0.1	95	60	80	0.3	0.6	-40 to +105	SOP8
BD7542SFVM	○														MSOP8	
LMR931G	—	1	1.8 to 5.0	80	1.0	5	28	V _{SS} to V _{DD}	V _{SS} +0.04 to V _{DD} -0.05	100	94	85	0.4	1.4	-40 to +85	SSOP5
LMR932F	—	2	1.8 to 5.0	135	1.0	5	28	V _{SS} to V _{DD}	V _{SS} +0.04 to V _{DD} -0.05	100	94	85	0.4	1.4	-40 to +85	SOP8
LMR932FJ	—														SOP-J8	
LMR932FV	—														SSOP-B8	
LMR932FVJ	—														TSSOP-B8J	
LMR932FVM	—														MSOP8	
LMR932FVT	—														TSSOP-B8	
LMR934F	—	4	1.8 to 5.0	250	1.0	5	28	V _{SS} to V _{DD}	V _{SS} +0.04 to V _{DD} -0.05	100	94	85	0.4	1.4	-40 to +85	SOP14
LMR934FJ	—														SOP-J14	
LMR934FV	—														SSOP-B14	
LMR934FVJ	—														TSSOP-B14J	
LMR981G	—	1	1.8 to 5.0	80	1.0	5	28	V _{SS} to V _{DD}	V _{SS} +0.04 to V _{DD} -0.05	100	94	85	0.4	1.4	-40 to +85	SSOP6
LMR982FVM	—	2	1.8 to 5.0	135	1.0	5	28	V _{SS} to V _{DD}	V _{SS} +0.04 to V _{DD} -0.05	100	94	85	0.4	1.4	-40 to +85	MSOP8

Product Grade : —Standard ○High Grade

A Amplifiers & Linear

Low Power Consumption

Ground Sense Operational Amplifiers

Part No.	Product Grade	CH	Supply Voltage (V)	Circuit Current (μA)	Input Offset Voltage (mV)	Input Bias Current (nA)	Output Current (mA)	Input Voltage Range (V)	Output Voltage Range (V)	Voltage Gain (dB)	CMRR (dB)	PSRR (dB)	Slew Rate (V/μs)	Gain Bandwidth Product (MHz)	Operating Temperature (°C)	Package														
BU7411G	—	1	1.6 to 5.5	0.35	1.0	0.001	2.4	V _{ss} to V _{DD} -1.0	V _{ss} +0.1 to V _{DD} -0.1	95	60	80	0.0024	0.004	-40 to +85	SSOP5														
BU7411SG	○															SSOP5														
BU7421G	—	1	1.7 to 5.5	8.5	1.0	0.001	4	V _{ss} to V _{DD} -1.2	V _{ss} +0.1 to V _{DD} -0.1	100	60	80	0.05	0.09	-40 to +85	SSOP5														
BU7421SG	○															SSOP5														
BU7441G	—	1	1.7 to 5.5	50	1.0	0.001	6	V _{ss} to V _{DD} -1.2	V _{ss} +0.1 to V _{DD} -0.1	95	60	80	0.3	0.6	-40 to +85	SSOP5														
BU7441SG	○															SSOP5														
BU7442F	—	2	1.7 to 5.5	100	1.0	0.001	6	V _{ss} to V _{DD} -1.2	V _{ss} +0.1 to V _{DD} -0.1	95	60	80	0.3	0.6	-40 to +85	SOP8														
BU7442FVM	—															MSOP8														
BU7442NUX	—	2	1.7 to 5.5	100	1.0	0.001	6	V _{ss} to V _{DD} -1.2	V _{ss} +0.1 to V _{DD} -0.1	95	60	80	0.3	0.6	-40 to +105	VSON008X2030														
BU7442SF	○															SOP8														
BU7442SFVM	○															MSOP8														
BU7442SNUX	○	2	1.7 to 5.5	100	1.0	0.001	6	V _{ss} to V _{DD} -1.2	V _{ss} +0.1 to V _{DD} -0.1	95	60	80	0.3	0.6	-40 to +105	VSON008X2030														
BU7444F	—															SOP14														
BU7444SF	○	4	1.7 to 5.5	200	1.0	0.001	6	V _{ss} to V _{DD} -1.2	V _{ss} +0.1 to V _{DD} -0.1	95	60	80	0.3	0.6	-40 to +105	SOP14														
BU7445HFV	—															HVSOF5														
BU7445SHFV	—	1	1.7 to 5.5	40	1.0	0.001	8	V _{ss} to V _{DD} -1.2	V _{ss} +0.1 to V _{DD} -0.1	100	60	80	0.25	0.4	-40 to +85	HVSOF5														
BU7475HFV	—															HVSOF5														
BU7475SHFV	○	1	1.7 to 5.5	9	1.0	0.001	7	V _{ss} to V _{DD} -1.2	V _{ss} +0.1 to V _{DD} -0.1	100	60	80	0.05	0.1	-40 to +105	HVSOF5														
BU7475SHFV	○															HVSOF5														
BD1321G	—	1	2.7 to 5.5	130	0.1	15	70	V _{EE} to V _{CC} -0.8	V _{EE} +0.08 to V _{CC} -0.04	110	90	90	1.0	3.0	-40 to +85	SSOP5														
LMR321G	—	1	2.7 to 5.5	130	0.1	15	70	V _{EE} to V _{CC} -0.8	V _{EE} +0.08 to V _{CC} -0.04	110	90	90	1.0	3.0	-40 to +85	SSOP5														
LMR324F	—	4	2.7 to 5.5	410	1.0	15	70	V _{EE} to V _{CC} -0.8	V _{EE} +0.08 to V _{CC} -0.04	110	90	90	1.0	3.0	-40 to +85	SOP14														
LMR324FJ	—															SOP-J14														
LMR324FV	—															SSOP-B14														
LMR324FVJ	—															TSSOP-B14J														
LMR341G	—	1	2.7 to 5.5	100	0.25	0.001	24	V _{ss} to V _{DD} -1.0	V _{ss} +0.06 to V _{DD} -0.06	103	80	85	1.0	2.0	-40 to +85	SSOP6														
LMR342F	—	2	2.7 to 5.5	200	0.25	0.001	24	V _{ss} to V _{DD} -1.0	V _{ss} +0.06 to V _{DD} -0.06	103	80	85	1.0	2.0	-40 to +85	SOP8														
LMR342FJ	—															SOP-J8														
LMR342FV	—															SSOP-B8														
LMR342FVJ	—															TSSOP-B8J														
LMR342FVM	—															MSOP8														
LMR342FVT	—															TSSOP-B8														
LMR344F	—															4	2.7 to 5.5	400	0.25	0.001	24	V _{ss} to V _{DD} -1.0	V _{ss} +0.06 to V _{DD} -0.06	103	80	85	1.0	2.0	-40 to +85	SOP14
LMR344FJ	—																													SOP-J14
LMR344FVJ	—	TSSOP-B14J																												
LMR358F	—	2	2.7 to 5.5	210	0.1	15	70	V _{EE} to V _{CC} -0.8	V _{EE} +0.08 to V _{CC} -0.04	110	90	90	1.0	3.0	-40 to +85	SOP8														
LMR358FJ	—															SOP-J8														
LMR358FV	—															SSOP-B8														
LMR358FVJ	—															TSSOP-B8J														
LMR358FVM	—															MSOP8														
LMR358FVT	—															TSSOP-B8														
LMR821G	—															1	2.5 to 5.5	280	1.0	30	16	V _{ss} to V _{DD} -0.9	V _{ss} +0.12 to V _{DD} -0.1	100	85	85	2.0	5.0	-40 to +85	SSOP5
LMR822F	—															2	2.5 to 5.5	560	1.0	30	16	V _{ss} to V _{DD} -0.9	V _{ss} +0.12 to V _{DD} -0.1	100	85	85	2.0	5.0	-40 to +85	SOP8
LMR822FJ	—	SOP-J8																												
LMR822FV	—	SSOP-B8																												
LMR822FVJ	—	TSSOP-B8J																												
LMR822FVM	—	MSOP8																												
LMR822FVT	—	TSSOP-B8																												
LMR824F	—	4	2.5 to 5.5	1,120	1.0	30	16	V _{ss} to V _{DD} -0.9	V _{ss} +0.12 to V _{DD} -0.1	100	85	85	2.0	5.0	-40 to +85	SOP14														
LMR824FJ	—															SOP-J14														
LMR824FVJ	—	—	—	—	—	—	—	—	—	—	—	—	—	—	—	TSSOP-B14J														
TLR341G	—	1	1.8 to 5.5	70	0.3	0.001	8	V _{ss} to V _{DD} -1.0	V _{ss} +0.055 to V _{DD} -0.05	100	90	95	1.2	2.2	-40 to +85	SSOP6														
TLR342F	—	2	1.8 to 5.5	150	0.3	0.001	8	V _{ss} to V _{DD} -1.0	V _{ss} +0.055 to V _{DD} -0.05	100	85	95	1.0	1.2	-40 to +85	SOP8														
TLR342FJ	—															SOP-J8														
TLR342FVJ	—															TSSOP-B8J														
TLR342FVT	—															TSSOP-B8														
TLR344F	—	4	1.8 to 5.5	300	0.3	0.001	8	V _{ss} to V _{DD} -1.0	V _{ss} +0.055 to V _{DD} -0.05	100	90	95	1.2	2.2	-40 to +85	SOP14														
TLR344FJ	—															SOP-J14														
TLR344FVJ	—															TSSOP-B14J														
LM324F	—	4	3.0 to 32.0	1,000	1.0	20	30	V _{EE} to V _{CC} -1.5	V _{EE} +0.01 to V _{CC} -1.5	100	80	100	0.3	0.8	-40 to +85	SOP14														
LM324FJ	—															SOP-J14														
LM324FV	—															SSOP-B14														
LM324FVJ	—															TSSOP-B14J														
LM358F	—															2	3.0 to 32.0	600	1.0	20	30	V _{EE} to V _{CC} -1.5	V _{EE} +0.01 to V _{CC} -1.5	100	80	100	0.3	0.8	-40 to +85	SOP8
LM358FJ	—	SOP-J8																												
LM358FV	—	SSOP-B8																												
LM358FVJ	—	TSSOP-B8J																												
LM358FVM	—	MSOP8																												
LM358FVT	—	TSSOP-B8																												

Automotive Ground Sense Operational Amplifiers

Part No.	Product Grade	CH	Supply Voltage (V)	Circuit Current (μA)	Input Offset Voltage (mV)	Input Bias Current (nA)	Output Current (mA)	Input Voltage Range (V)	Output Voltage Range (V)	Voltage Gain (dB)	CMRR (dB)	PSRR (dB)	Slew Rate (V/μs)	Gain Bandwidth Product (MHz)	Operating Temperature (°C)	Package	Automotive Grade AEC-Q100
BU7241YG-C	●	1	1.8 to 5.5	70	1.0	0.001	10	V _{ss} to V _{DD}	V _{ss} +0.05 to V _{DD} -0.05	100	70	80	0.4	1.0	-40 to +125	SSOP5	YES
BU7242YFVM-C	●	2	1.8 to 5.5	180	1.0	0.001	10	V _{ss} to V _{DD}	V _{ss} +0.05 to V _{DD} -0.05	100	70	80	0.4	1.0	-40 to +125	MSOP8	YES

Product Grade : —Standard ○High Grade ●Automotive Grade

Low Noise

Output Full Swing Operational Amplifiers																
Part No.	Product Grade	CH	Supply Voltage (V)	Circuit Current (mA)	Input Offset Voltage (mV)	Input Bias Current (nA)	Input Referred Noise Voltage (μ Vrms)	Input Voltage Range (V)	Output Voltage Range (V)	Voltage Gain (dB)	CMRR (dB)	PSRR (dB)	Slew Rate (V/ μ s)	Gain Bandwidth Product (MHz)	Operating Temperature (°C)	Package
BA4510F	—	2	± 1 to ± 3.5	5.0	1.0	80	0.7	VEE to VCC-1.5	VEE+0.1 to VCC-0.1	90	80	80	5.0	10.0	-20 to +75	SOP8
BA4510FV	SSOP-B8															
BA4510FVM	MSOP8															
BA4510FVT	TSSOP-B8															
BA2107G	—	1	± 1 to ± 7	1.8	1.0	150	0.9	VEE to VCC-1.5	VEE+0.3 to VCC-0.3	80	74	80	4.0	12.0	-40 to +85	SSOP5
BA2115F	—	2	± 1 to ± 7	3.5	1.0	150	0.9	VEE to VCC-1.5	VEE+0.3 to VCC-0.3	80	74	80	4.0	12.0	-40 to +85	SOP8
BA2115FJ	SOP-J8															
BA2115FVM	MSOP8															

Automotive Operational Amplifiers																	
Part No.	Product Grade	CH	Supply Voltage (V)	Circuit Current (mA)	Input Offset Voltage (mV)	Input Bias Current (nA)	Input Referred Noise Voltage (μ Vrms)	Input Voltage Range (V)	Output Voltage Range (V)	Voltage Gain (dB)	CMRR (dB)	PSRR (dB)	Slew Rate (V/ μ s)	Gain Bandwidth Product (MHz)	Operating Temperature (°C)	Package	Automotive Grade AEC-Q100
BA4558YF-M	●	2	± 4 to ± 15	3.0	0.5	60	1.8	VEE+1.0 to VCC-1.0	VEE+1.0 to VCC-1.0	100	90	90	1.0	2.0	-40 to +105	SOP8	YES
BA4558YFV-M	SSOP-B8															YES	
BA4558YFVM-M	MSOP8															YES	
BA4560YF-M	●	2	± 4 to ± 15	3.0	0.5	50	1.0	VEE+1.0 to VCC-1.0	VEE+1.0 to VCC-1.0	100	90	90	4.0	4.0	-40 to +105	SOP8	YES
BA4560YFV-M	SSOP-B8															YES	
BA4560YFVM-M	MSOP8															YES	
BA4580YF-M	●	2	± 2 to ± 16	6.0	0.3	100	0.8	VEE+1.5 to VCC-1.5	VEE+1.5 to VCC-1.5	110	110	110	5.0	10.0	-40 to +105	SOP8	YES
BA4580YFVM-M	MSOP8															YES	
BA4584YFV-M	●	4	± 2 to ± 16	11.0	0.3	100	0.8	VEE+1.5 to VCC-1.5	VEE+1.5 to VCC-1.5	110	110	110	5.0	10.0	-40 to +105	SSOP-B14	YES

Dual Supply Voltage Operational Amplifiers																
Part No.	Product Grade	CH	Supply Voltage (V)	Circuit Current (mA)	Input Offset Voltage (mV)	Input Bias Current (nA)	Input Referred Noise Voltage (μ Vrms)	Input Voltage Range (V)	Output Voltage Range (V)	Voltage Gain (dB)	CMRR (dB)	PSRR (dB)	Slew Rate (V/ μ s)	Gain Bandwidth Product (MHz)	Operating Temperature (°C)	Package
BA4558F	—	2	± 4 to ± 15	3.0	0.5	60	1.8	VEE+1.0 to VCC-1.0	VEE+1.0 to VCC-1.0	100	90	90	1.0	2.0	-40 to +85	SOP8
BA4558FJ	SOP-J8															
BA4558FV	SSOP-B8															
BA4558FVM	MSOP8															
BA4558FVT	—	TSSOP-B8														
BA4558RF	○	2	± 4 to ± 15	3.0	0.5	60	1.8	VEE+1.0 to VCC-1.0	VEE+1.0 to VCC-1.0	100	90	90	1.0	2.0	-40 to +105	SOP8
BA4558RFJ	SOP-J8															
BA4558RFV	SSOP-B8															
BA4558RFVM	MSOP8															
BA4558RFVT	○	TSSOP-B8														
BA4560F	—	2	± 4 to ± 15	4.0	0.5	50	1.0	VEE+1.0 to VCC-1.0	VEE+1.0 to VCC-1.0	100	90	90	4.0	10.0	-40 to +85	SOP8
BA4560FJ	SOP-J8															
BA4560FV	SSOP-B8															
BA4560FVM	MSOP8															
BA4560FVT	—	TSSOP-B8														
BA4560RF	○	2	± 4 to ± 15	3.0	0.5	50	1.0	VEE+1.0 to VCC-1.0	VEE+1.0 to VCC-1.0	100	90	90	4.0	4.0	-40 to +105	SOP8
BA4560RFJ	SOP-J8															
BA4560RFV	SSOP-B8															
BA4560RFVM	MSOP8															
BA4560RFVT	○	TSSOP-B8														
BA4564RFV	○	4	± 4 to ± 15	6.0	0.5	50	1.0	VEE+1.0 to VCC-1.0	VEE+1.0 to VCC-1.0	100	90	90	4.0	4.0	-40 to +105	SSOP-B14
BA15218F	—	2	± 2 to ± 16	5.0	0.5	50	1.0	VEE+1.0 to VCC-1.0	VEE+2.0 to VCC-2.0	110	90	90	3.0	10.0	-40 to +85	SOP8
BA14741F	—	4	± 2 to ± 18	3.0	1.0	60	2.0	VEE+1.5 to VCC-1.5	VEE+2.5 to VCC-2.5	100	100	100	1.0	2.0	-40 to +85	SOP14
BA14741FJ	SOP-J14															
BA15532F	—	2	± 3 to ± 20	8.0	0.5	200	1.5	VEE+2.0 to VCC-2.0	VEE+2.0 to VCC-2.0	94	100	100	8.0	20.0	-20 to +75	SOP8
BA4580RF	○	2	± 2 to ± 16	6.0	0.3	100	0.8	VEE+1.5 to VCC-1.5	VEE+1.5 to VCC-1.5	110	110	110	5.0	5.0	-40 to +105	SOP8
BA4580RFJ	SOP-J8															
BA4580RFVM	MSOP8															
BA4580RFVT	○															TSSOP-B8
BA4584FV	—	4	± 2 to ± 16	12.0	0.3	100	0.8	VEE+1.5 to VCC-1.5	VEE+1.5 to VCC-1.5	110	110	110	5.0	5.0	-40 to +85	SSOP-B14
BA4584RF	○	4	± 2 to ± 9.5	11.0	0.3	100	0.8	VEE+1.5 to VCC-1.5	VEE+1.5 to VCC-1.5	110	110	110	5.0	5.0	-40 to +105	SOP14
BA4584RFV	SSOP-B14															
LM4559F	—	2	± 4 to ± 18	3.3	0.5	40	0.7	VEE+2.0 to VCC-2.0	VEE+1.5 to VCC-1.5	110	100	100	3.5	4.0	-40 to +85	SOP8
LM4559FJ	SOP-J8															
LM4559FV	SSOP-B8															
LM4559FVT	TSSOP-B8															
LM4559FVM	MSOP8															
LM4559FVJ	TSSOP-B8&J															
LM4565F	—	2	± 4 to ± 18	4.5	0.5	70	0.6	VEE+1.0 to VCC-1.0	VEE+1.0 to VCC-1.0	100	100	100	5.0	10.0	-40 to +85	SOP8
LM4565FJ	SOP-J8															
LM4565FV	SSOP-B8															
LM4565FVT	TSSOP-B8															
LM4565FVM	MSOP8															
LM4565FVJ	TSSOP-B8&J															

Product Grade : ○—Standard ○—High Grade ●—Automotive Grade

Low Offset Voltage
Dual Supply Voltage Operational Amplifier

Part No.	Product Grade	CH	Supply Voltage (V)	Circuit Current (mA)	Input Offset Voltage (mV)	Input Bias Current (nA)	Output Current (mA)	Input Voltage Range (V)	Output Voltage Range (V)	Voltage Gain (dB)	CMRR (dB)	PSRR (dB)	Slew Rate (V/μs)	Gain Bandwidth Product (MHz)	Operating Temperature (°C)	Package
BA4564WV	○	4	±4 to ±15	6.0	0.5	50	25	VEE+1.0 to VCC-1.0	VEE+1.0 to VCC-1.0	100	90	90	4.0	4.0	-40 to +105	SSOP-B14
Input-Output Full Swing Operational Amplifier																
BD5291G	—	1	1.7 to 5.5	0.65	0.1	0.001	6	VSS to VDD	VSS+0.1 to VDD-0.1	110	90	90	2.5	3.2	-40 to +85	SSOP5

Product Grade : — Standard ○ High Grade

Comparators

Standard
Open-Collector Comparators

Part No.	Product Grade	CH	Supply Voltage (V)	Circuit Current (mA)	Input Offset Voltage (mV)	Input Bias Current (nA)	Output Current (mA)	Input Voltage Range (V)	Voltage Gain (dB)	Response Time (μs)	Operating Temperature (°C)	Package
BA2901F	○	4	2 to 36	0.8	2	50	16	VEE to VCC-1.5	100	1.3	-40 to +125	SOP14
BA2901FV	○											SSOP-B14
BA2901SF	○	4	2 to 36	0.8	2	50	16	VEE to VCC-1.5	100	1.3	-40 to +105	SOP14
BA2901SFV	○											SSOP-B14
BA2901YF-LB	○	4	2 to 36	0.8	2	50	16	VEE to VCC-1.5	100	1.3	-40 to +125	SOP14
BA2903F	○	2	2 to 36	0.6	2	50	16	VEE to VCC-1.5	100	1.3	-40 to +125	SOP8
BA2903FV	○											SSOP-B8
BA2903FVM	○											MSOP8
BA2903SF	○	2	2 to 36	0.6	2	50	16	VEE to VCC-1.5	100	1.3	-40 to +105	SOP8
BA2903SFV	○											SSOP-B8
BA2903SFVM	○											MSOP8
BA2903YF-LB	○	2	2 to 36	0.6	2	50	16	VEE to VCC-1.5	100	1.3	-40 to +125	SOP8
BA8391G	—	1	2 to 36	0.3	2	50	16	VEE to VCC-1.5	100	1.3	-40 to +85	SSOP5
New LM2901F	○	4	3 to 32	1.2	1	50	16	VEE to VCC-1.5	120	1.0	-40 to +125	SOP14
New LM2901FJ	○											SOP-J14
New LM2901FV	○											SSOP-B14
New LM2901FVJ	○											TSSOP-B14J
New LM2903F	○	2	3 to 32	0.6	1	50	16	VEE to VCC-1.5	120	1.0	-40 to +125	SOP8
New LM2903FJ	○											SOP-J8
New LM2903FV	○											SSOP-B8
New LM2903FVJ	○											TSSOP-B8J
New LM2903FVM	○											MSOP8
New LM2903FVT	○											TSSOP-B8
New LM339F	—	4	3 to 32	1.2	1	50	16	VEE to VCC-1.5	120	1.0	-40 to +85	SOP14
New LM339FJ	—											SOP-J14
New LM339FV	—											SSOP-B14
New LM339FVJ	—											TSSOP-B14J
LM393F	—	2	3 to 32	0.6	1	50	16	VEE to VCC-1.5	120	1.0	-40 to +85	SOP8
New LM393FJ	—											SOP-J8
New LM393FV	—											SSOP-B8
New LM393FVJ	—											TSSOP-B8J
New LM393FVM	—											MSOP8
New LM393FVT	—											TSSOP-B8

Automotive Open-Collector Comparators

Part No.	Product Grade	CH	Supply Voltage (V)	Circuit Current (mA)	Input Offset Voltage (mV)	Input Bias Current (nA)	Output Current (mA)	Input Voltage Range (V)	Voltage Gain (dB)	Response Time (μs)	Operating Temperature (°C)	Package	Automotive Grade AEC-Q100
BA2903YF-C	●	2	2 to 36	0.6	2	50	16	VEE to VCC-1.5	100	1.3	-40 to +125	SOP8	Yes
BA2903YFV-C	●											SSOP-B8	Yes
BA2903YFVM-C	●											MSOP8	Yes
BA2901YF-C	●	4	2 to 36	0.8	2	50	16	VEE to VCC-1.5	100	1.3	-40 to +125	SOP14	Yes
BA2901YFV-C	●											SSOP-B14	Yes
BA2903YF-M	●	2	2 to 36	0.6	2	50	16	VEE to VCC-1.5	100	1.3	-40 to +125	SOP8	Yes
BA2903YFV-M	●											SSOP-B8	Yes
BA2903YFVM-M	●											MSOP8	Yes
BA2901YF-M	●	4	2 to 36	0.8	2	50	16	VEE to VCC-1.5	100	1.3	-40 to +125	SOP14	Yes
BA2901YFV-M	●											SSOP-B14	Yes

Product Grade : — Standard ○ High Grade ● Automotive Grade

High Speed

Push-Pull Comparators												
Part No.	Product Grade	CH	Supply Voltage (V)	Circuit Current (μA)	Input Offset Voltage (mV)	Input Bias Current (nA)	Output Current (mA)	Input Voltage Range (V)	Voltage Gain (dB)	Response Time (μs)	Operating Temperature (°C)	Package
BU7251G	—	1	1.8 to 5.5	15	1	0.001	6	V _{SS} to V _{DD}	90	0.55	-40 to +85	SSOP5
BU7251SG	○										-40 to +105	SSOP5
BU7252F	—	2	1.8 to 5.5	35	1	0.001	6	V _{SS} to V _{DD}	90	0.55	-40 to +85	SOP8
BU7252FVM	—										-40 to +85	MSOP8
BU7252SF	○	2	1.8 to 5.5	35	1	0.001	6	V _{SS} to V _{DD}	90	0.55	-40 to +105	SOP8
BU7252SFVM	○										-40 to +105	MSOP8
BU5265HFV	—	1	1.8 to 5.5	22	1	0.001	3.5	V _{SS} to V _{DD}	90	0.5	-40 to +85	HVSOF5
BU5265SHFV	○										-40 to +105	HVSOF5

Open-Drain Comparators												
Part No.	Product Grade	CH	Supply Voltage (V)	Circuit Current (μA)	Input Offset Voltage (mV)	Input Bias Current (nA)	Output Current (mA)	Input Voltage Range (V)	Voltage Gain (dB)	Response Time (μs)	Operating Temperature (°C)	Package
BU7250G	—	1	1.8 to 5.5	15	1	0.001	6	V _{SS} to V _{DD}	90	0.75	-40 to +85	SSOP5
BU7250SG	○										-40 to +105	SSOP5
BU7253F	—	2	1.8 to 5.5	35	1	0.001	6	V _{SS} to V _{DD}	90	0.75	-40 to +85	SOP8
BU7253SF	○										-40 to +105	SOP8

Product Grade : —Standard ○High Grade

Low Power Consumption

Push-Pull Comparators												
Part No.	Product Grade	CH	Supply Voltage (V)	Circuit Current (μA)	Input Offset Voltage (mV)	Input Bias Current (nA)	Output Current (mA)	Input Voltage Range (V)	Voltage Gain (dB)	Response Time (μs)	Operating Temperature (°C)	Package
BU7231G	—	1	1.8 to 5.5	5	1	0.001	6	V _{SS} to V _{DD}	90	1.7	-40 to +85	SSOP5
BU7231SG	○										-40 to +105	SSOP5
BU7232F	—	2	1.8 to 5.5	10	1	0.001	6	V _{SS} to V _{DD}	90	1.7	-40 to +85	SOP8
BU7232FVM	—										-40 to +85	MSOP8
BU7232SF	○	2	1.8 to 5.5	10	1	0.001	6	V _{SS} to V _{DD}	90	1.7	-40 to +105	SOP8
BU7232SFVM	○										-40 to +105	MSOP8
BU5255HFV	—	1	1.8 to 5.5	6.5	1	0.001	3.5	V _{SS} to V _{DD}	90	1.6	-40 to +85	HVSOF5
BU5255SHFV	○										-40 to +105	HVSOF5

Open-Drain Comparators												
Part No.	Product Grade	CH	Supply Voltage (V)	Circuit Current (μA)	Input Offset Voltage (mV)	Input Bias Current (nA)	Output Current (mA)	Input Voltage Range (V)	Voltage Gain (dB)	Response Time (μs)	Operating Temperature (°C)	Package
BU7230G	—	1	1.8 to 5.5	5	1	0.001	6	V _{SS} to V _{DD}	90	1.8	-40 to +85	SSOP5
BU7230SG	○										-40 to +105	SSOP5
BU7233F	—	2	1.8 to 5.5	10	1	0.001	6	V _{SS} to V _{DD}	90	1.8	-40 to +85	SOP8
BU7233SF	○										-40 to +105	SOP8

Automotive Open-Drain Comparator													
Part No.	Product Grade	CH	Supply Voltage (V)	Circuit Current (μA)	Input Offset Voltage (mV)	Input Bias Current (nA)	Output Current (mA)	Input Voltage Range (V)	Voltage Gain (dB)	Response Time (μs)	Operating Temperature (°C)	Package	Automotive Grade AEC-Q100
BU7233YF-C	●	2	1.8 to 5.5	10	1	0.001	7	V _{SS} to V _{DD}	100	1.8	-40 to +125	SOP8	YES

Product Grade : —Standard ○High Grade ●Automotive Grade

Transistor Arrays

Darlington Transistor Arrays

Open Collectors

Part No.	Number of bit	Output Withstand Voltage (V)	Output Saturation Voltage (V)	Output Current (mA)	Input Resistance (k Ω)	Input/Output Relation	Input Active Level	Output Current Relation	Circuit Construction	Features	Package
BA12003BF	7	60	1.46*	500	2.7	Inverting Type	H	Sink	Darlington	Built-in surge absorbing diode	SOP16
BA12004BF	7	60	1.46*	500	10.5	Inverting Type	H	Sink	Darlington	Built-in surge absorbing diode	SOP16

* Output Current=350mA



ICs

Clocks & Timers

CONTENTS

High-performance Clock Generators ICs P. A20

Clock Generators for Digital Cameras P. A20

DVD-Audio Reference Clock Generator for A/V Equipments P. A20

DVD-Video Reference Clock Generators for A/V Equipments P. A20

Clock Generator with Built-in VCXO for A/V Equipments P. A20

Real Time Clocks ICs P. A20

Real Time Clocks with High-precision Oscillation Adjustment P. A20

High-performance Clock Generators ICs

A
Clocks & Timers

Clock Generators for Digital Cameras

Part No.	Supply Voltage (V)	Reference Frequency (MHz)	Video Clock (The output which can be selected) (MHz)	CCD Clock (The output which can be selected) (MHz)	USB Clock (MHz)	Jitter 1 σ Typ. (ps)	Package
BU2394KN	3.0 to 3.6	14.318182 (28.636363)	14.318182 17.734450	135.000000 108.000000 98.181818 110.000000	48.008022	30	VQFN20
BU2396KN	3.0 to 3.6	12.000000	27.000000	24.000000 30.000000 36.000000	12.000000	50	VQFN20

DVD-Audio Reference Clock Generator for A/V Equipments

Part No.	Supply Voltage (V)	Reference Frequency (MHz)	Output Frequency(MHz)								Jitter 1 σ Typ. (ps)	C/N Typ. (ps)	Package	
			DVD-video Clock			DVD, Audio, CD Clock (The output which can be switched)				System Clock				
			Video1	Video2	Video3	768fs	512fs	384fs	256fs	768fs				384fs
BU2363FV	3.0 to 3.6	36.864	54.0000	27.0000	—	36.8640 33.8688	—	18.4320 16.9344	—	33.8688	16.9344	50	-75 (Video)	SSOP-B16

DVD-Video Reference Clock Generators for A/V Equipments

Part No.	Supply Voltage (V)	Reference Frequency (MHz)	Output Frequency(MHz)										Jitter 1 σ Typ. (ps)	Long-term Jitter P-P Typ. (ns)	Package
			DVD-video Clock			DVD, Audio, CD Clock (The output which can be switched)				System Clock					
			Video1	Video2	Video3	768fs	512fs	384fs	Other	768fs	384fs	Other			
BU2280FV	3.0 to 3.6	27.0000	27.0000	—	—	36.8640 33.8688	24.5760 22.5792	18.4320 16.9344	—	33.8688	—	—	70	8 (Audio)	SSOP-B24
BU2360FV	2.7 to 3.6	27.0000	27.0000	—	—	—	24.5760 22.5792	—	—	33.8688	—	—	70	2.5 (Audio)	SSOP-B16
BU2362FV	2.7 to 3.6	27.0000	27.0000	—	—	—	24.5760 22.5792	—	36.8640 16.9344	33.8688	16.9344	36.864	70	12 (Audio)	SSOP-B16

Clock Generator with Built-in VCXO for A/V Equipments

Part No.	Supply Voltage (V)	VCXO (Reference Clock)	Clock Buffer	PLL Output Frequency(MHz)								Jitter 1 σ Typ. (ps)	C/N Typ. (dB)	Package		
				DVD-video Clock			DVD, Audio, CD Clock (The output which can be switched)				System Clock					
				Video1	Video2	Video3	768fs				768fs				512fs	384fs
BU3087FV	3.135 to 3.465	Tuning range 27MHz \pm 105ppm Typ.	—	27.000000	—	74.250000 Modulation \pm 0.25% \pm 0.50% \pm 0.75% \pm 1.00%	—	—	—	—	—	—	30	HD -Video -70	SSOP-B16	

Clock Generators for Digital Cameras : Three types of clocks generated-CCD, USB, and a Video
 DVD-Audio Reference Clock Generators : DVD/CD-audio, DVD-video clock generation using the DVD-video reference clock
 DVD-Video Reference Clock Generators for A/V Equipments : DVD/CD-audio, DVD-video clock generation using the DVD-video reference clock
 Clock Generator with Built-in VCXO for A/V Equipments : VCXO is Built-in with high-precision external synchronization

Real Time Clocks ICs

Real Time Clocks with High-precision Oscillation Adjustment

Part No.	I/F	Supply Voltage (V)	Time Keeping Voltage (V)	Time Keeping Current (Typ.)(μ A)	Time Keeping Current (Max.)(μ A)	Operating Frequency 1 (Max.)(kHz)	Operating Frequency 2 (Max.)(kHz)	Package
BU9873F	I ² C	1.8 to 5.5	1.45 to 5.5	0.4 (V _{DD} =3V, Ta=25°C)	1.0 (V _{DD} =3V, Ta=-40°C to +85°C)	100 (V _{DD} =1.8V to 2.5V)	400 (V _{DD} =2.5V to 5.5V)	SOP8
BU9873FJ								SOP-J8
BU9873FVT								TSSOP-B8
BU9873FVM								MSOP8
BU9873NUX								VSON008X2030



ICs

Switch & IPD & Multiplexer & Logic

CONTENTS

Standard Logic	P. A22
Analog Switch/Analog Switch(Single type)	P. A22
Multiplexer	P. A22
Logic Gates	P. A22
Logic Gates(Single type)	P. A22
Function Logic	P. A22
Serial-in/Parallel-out Drivers	P. A22
Serial/Parallel 2-input Drivers	P. A22
Serial/Parallel 4-input Drivers	P. A22
USB Switch ICs	P. A23
SP type(Single Pole)	P. A23
DP type(Double Pole)	P. A23
Built-in OVP Micro USB Switch with USB2.0, MHL™ and Audio	P. A23
IPD(Intelligent Power Device)	P. A23
High Side Switch	P. A23
Low Side Switch	P. A23

Standard Logic

A Switch & IPD & Multiplexer & Logic

Analog Switch/Analog Switch(Single type)												
Type	Package/Part No.			Function	Supply Voltage (V)	H Input Voltage (Min.)(V)	L Input Voltage (Max.)(V)	ON Resistance (Max.)(Ω)	Control-output Propagation Delay Time (Typ.)(ns)	IN-Out Propagation Delay Time (Typ.)(ns)	Max. Propagation Frequency (Typ.)(MHz)	
	SOP16(14)	SSOP-B16(14)	SSOP5									
BU4066BC	BU4066BCF	BU4066BCFV	—	Quad Analog Switch	3 to 18	3.5	1.5	950	60	20	—	
BU4S66	—	—	BU4S66G2	Single Analog Switch	3 to 16	3.5	1.5	950	80	15	—	
Multiplexer												
Type	Package/Part No.			Function	Supply Voltage (V)	H Input Voltage (Min.)(V)	L Input Voltage (Max.)(V)	ON Resistance (Max.)(Ω)	Control-output Propagation Delay Time (Typ.)(ns)	IN-Out Propagation Delay Time (Typ.)(ns)	Max. Propagation Frequency (Typ.)(MHz)	
	SOP16(14)	SSOP-B16(14)	SSOP5									
BU4051BC	BU4051BCF	BU4051BCFV	—	Analog Multiplexer/Demultiplexer(8→1)	3 to 18	3.5	1.5	950	170	15	20	
BU4052BC	BU4052BCF	BU4052BCFV	—	Dual Analog Multiplexer/Demultiplexer(4→1)	3 to 18	3.5	1.5	950	170	15	20	
BU4551B	BU4551BF	BU4551BFV	—	Quad Analog Multiplexer/Demultiplexer(2→1)	3 to 16	3.5	1.5	1,100	360	35	15	
Logic Gates												
Type	Package/Part No.		Function	Supply Voltage (V)	H Input Voltage (Min.)(V)	L Input Voltage (Max.)(V)	Hysteresis Voltage (V)	H Output Voltage I _{out} =0mA (Min.)(V)	L Output Voltage I _{out} =0mA (Max.)(V)	Propagation Delay Time (Typ.)(ns)		
	SOP14	SSOP-B14										
BU4030B	BU4030BF	—	Quad Exclusive OR Gate	3 to 16	3.5	1.5	—	4.95	0.05	90		
BU4069UB	BU4069UBF	BU4069UBFV	Hex Unbuffer Inverter	3 to 16	4.0	1.0	—	4.95	0.05	90		
Logic Gates(Single type)												
Type	Package/Part No.	Function	Supply Voltage (V)	H Input Voltage (Min.)(V)	L Input Voltage (Max.)(V)	Hysteresis Voltage (V)	H Output Voltage I _{out} <1μA (Min.)(V)	L Output Voltage I _{out} <1μA (Max.)(V)	Propagation Delay Time (Typ.)(ns)			
	SSOP5											
BU4S01	BU4S01G2	Single NOR Gate	3 to 16	3.5	1.5	—	4.95	0.05	85			
BU4S11	BU4S11G2	Single NAND Gate	3 to 16	3.5	1.5	—	4.95	0.05	85			
BU4SU69	BU4SU69G2	Single Unbuffer Inverter	3 to 16	4.0	1.0	—	4.95	0.05	55			
BU4S71	BU4S71G2	Single OR Gate	3 to 16	3.5	1.5	—	4.95	0.05	90			
BU4S81	BU4S81G2	Single AND Gate	3 to 16	3.5	1.5	—	4.95	0.05	90			
BU4S584	BU4S584G2	Single Schmitt Trigger	3 to 16	3.5	1.5	0.15 to 0.6	4.95	0.05	125			
Function Logic												
Type	Package/Part No.		Function	Supply Voltage (V)	H Input Voltage (Min.)(V)	L Input Voltage (Max.)(V)	H Output Voltage I _{out} =0mA (Min.)(V)	L Output Voltage I _{out} =0mA (Max.)(V)	Propagation Delay Time (Typ.)(ns)	Max. Clock Frequency (Typ.)(MHz)	Set up Time (Typ.)(ns)	Hold Time (Typ.)(ns)
	SOP16	SSOP-B16										
BU4094BC	BU4094BCF	BU4094BCFV	8-Stage Shift/Store Register(3-State)	3 to 18	3.5	1.5	4.95	0.05	420	2.5	20	10

Serial-in/Parallel-out Drivers

Serial/Parallel 2-input Drivers							
Part No.	Number of Input	Number of Output	Supply Voltage (V)	Max. Output Current (mA)	Max. Output Voltage (V)	Output Type	Package
BU2098F	2	8	2.7 to 5.5	25	15	Open drain	SOP16
BU2090F	2	12	2.7 to 5.5	25	25	Open drain	SOP16
BU2090FS	2	12	2.7 to 5.5	25	25	Open drain	SSOP-A16
Serial/Parallel 4-input Drivers							
BU2050F	4	8	4.5 to 5.5	25	5.5	CMOS	SOP14
BU2092F	4	12	2.7 to 5.5	25	25	Open drain	SOP18
BU2092FV	4	12	2.7 to 5.5	25	25	Open drain	SSOP-B20
BU2099FV	4	12	2.7 to 5.5	25	25	Open drain	SSOP-B20
BU2152FS	4	24	2.7 to 5.5	25	5.5	CMOS	SSOP-A32

Serial/Parallel 2-input Drivers : 2-wires Interface CLOCK, DATA
 Serial/Parallel 4-input Drivers : 4-wires Interface CLOCK, DATA, LATCH, ENABLE

USB Switch ICs

SP type(Single Pole)													
Part No.	Supply Voltage(V)		USB Switch	UART Switch	Circuit Current (μA)	USB Switch ON Resistance(Ω)	USB Switch ON Capacitance(pF)	Package					
	USB	UART											
BH6260MWX	2.9 to 3.7	1.7 to 3.6	1ch	1ch	0	5	10	USON016X3315					
DP type(Double Pole)													
BD11600NUX	2.5 to 5.5	—	1ch	—	18	3	6	VSON010X3020					
BD11603MWX	2.5 to 5.5	—	2ch	—	18	3	7	USON016X3315					
BD11601NUX	2.5 to 5.5	—	1ch	—	18	2.5	6	VSON008X2020					
New BD11670GWL	3.8 to 28.0	—	1ch	—	26	5	6	UCSP50L1C					
Built-in OVP Micro USB Switch with USB2.0, MHL™ and Audio													
Part No.	Supply Voltage(V)			USB/MHL Switch	MIC Switch	HP Switch	VBUS Signal Path	ID-CBUS Path	OTG-VBUS Voltage Path	Stand by Current (μA)	USB/MHL Switch ON Resistance(Ω)	USB/MHL Switch ON Capacitance(pF)	Package
	VBUS	VBAT	VDDIO										
BD91411GW	3.8 to 28	2.9 to 4.6	1.7 to 3.0	2ch	1ch(mono)	1ch	1ch	1ch	1ch	6	5	6	UCSP75M3

IPD(Intelligent Power Device)

High Side Switch

Smart High Side Switch								
Part No.	Power Supply (V)	VDS (Max.)(V)	Channel (ch)	I _{oCP} (Min.)(A)	ON Resistance (Typ.)(mΩ)	Thermal Shut Down	Package	Automotive Grade AEC-Q100
New BV1HD090FJ-C	4.5 to 36.0	45.0	1	2.7	90	Self-restart	SOP-J8	YES
BD1HC500EFJ-C	4.0 to 18.0	44.5	1	0.8	500	Off-latch	HTSOP-J8	YES
BD1HC500FVM-C	4.0 to 18.0	44.5	1	0.8	500	Off-latch	MSOP-8	YES
BD1HC500HFN-C	4.0 to 18.0	44.5	1	0.8	500	Off-latch	HSON-8	YES
BD1HD500EFJ-C	4.0 to 18.0	44.5	1	0.8	500	Self-restart	HTSOP-J8	YES
BD1HD500FVM-C	4.0 to 18.0	44.5	1	0.8	500	Self-restart	MSOP-8	YES
BD1HD500HFN-C	4.0 to 18.0	44.5	1	0.8	500	Self-restart	HSON-8	YES

Low Side Switch

Smart Low Side Switch								
Part No.	Power Supply (V)	VDS (Max.)(V)	Channel (ch)	I _{oCP} (Min.)(A)	ON Resistance (Typ.)(mΩ)	Thermal Shut Down	Package	Automotive Grade AEC-Q100
New BV1LB028FPJ-C	3.0 to 5.5	42	1	30	28	Self-restart	TO252-J3	YES
New BV1LB045FPJ-C	3.0 to 5.5	42	1	18	45	Self-restart	TO252-J3	YES
BV1LB085FJ-C	3.0 to 5.5	42	1	13	85	Self-restart	SOP-J8	YES
New BV1LC105FJ-C	3.0 to 5.5	42	1	3	105	Self-restart	SOP-J8	YES
BV1LB150FJ-C	3.0 to 5.5	42	1	6.5	150	Self-restart	SOP-J8	YES
BV1LB300FJ-C	3.0 to 5.5	42	1	1.7	300	Self-restart	SOP-J8	YES
New BV1LB300HFS-C	3.0 to 5.5	42	1	1.7	300	Self-restart	HSON-A8	YES
BD1LB500EFJ-C	3.5 to 5.5	42	1	0.8	350	Self-restart	HTSOP-J8	YES
BD1LB500FVM-C	3.5 to 5.5	42	1	0.8	350	Self-restart	MSOP8	YES
New BM2LC105FJ-C	3.0 to 5.5	42	2	3	105	Self-restart	SOP-J8	YES
BM2LB110FJ-C	3.0 to 5.5	42	2	2.5	120	Self-restart	SOP-J8	YES
BM2LB150FJ-C	3.0 to 5.5	42	2	6.5	150	Self-restart	SOP-J8	YES
BM2LB300FJ-C	3.0 to 5.5	42	2	1.7	300	Self-restart	SOP-J8	YES
BD8LB600FS-C	3.0 to 5.5(Digital)/ 4.0 to 5.5(Analog)	45	8	1	600	Self-restart	SSOP-A24	YES
BD8LA700EFV-C	3.0 to 5.5(Digital)/ 4.0 to 5.5(Analog)	45	8	0.5	700	Off-latch	HTSSOP-B24	YES



ICs

Data Converter

CONTENTS

A/D Converter	P. A26
10bit	P. A26
12bit	P. A26
D/A Converters	P. A26
8bit	P. A26
10bit	P. A26

A/D Converters

10bit

10bit								
Part No.	Supply Voltage (V)	CH	Analog Input Type	Sampling Frequency (SPS)	Interface	DNL (LSB)	INL (LSB)	Package
BH2715FV	2.7 to 5.25	8	Single ended	50k to 220k	SPI	±1.2	±1.5	SSOP-B16

12bit

12bit								
Part No.	Supply Voltage (V)	CH	Analog Input Type	Sampling Frequency (SPS)	Interface	DNL (LSB)	INL (LSB)	Package
New BU1S12S1AG-LB	2.7 to 5.25	1	Single ended	0.5M to 1M	SPI	-0.9 Min./ +1.0 Max.	-1.1 Min./ +1.0 Max.	SSOP6

D/A Converters

8bit

Standard 8bit Resolution The converter allows the output voltage to be set with 8-bit precision (256 steps). These popular converters offer feature-rich, highly integrated capabilities.										
Part No.	Supply Voltage (V)	CH	Current Consumption (mA)	DNL (LSB)	INL (LSB)	Load Current (mA)	Data Transfer Clock Frequency (MHz)	Input Type	Data Latch Method	Package
BH2219FVM	2.7 to 5.5	2	0.4	±1.0	±1.5	±1.0	10	CMOS	LD	MSOP8
BH2220FVM	2.7 to 5.5	3	0.4	±1.0	±1.5	±1.0	10	CMOS	LD	MSOP8
BH2227FV	2.7 to 5.5	4	0.8	±1.0	±1.5	±1.0	10	CMOS	CSB	SSOP-B14
BH2228FV	2.7 to 5.5	6	0.8	±1.0	±1.5	±1.0	10	CMOS	CSB	SSOP-B14
BH2226FV	2.7 to 5.5	8	1.1	±1.0	±1.5	±1.0	10	CMOS	CSB	SSOP-B16
BH2226F	2.7 to 5.5	8	1.1	±1.0	±1.5	±1.0	10	CMOS	CSB	SOP16
BH2223FV	2.7 to 5.5	10	1.6	±1.0	±1.5	±1.0	10	CMOS	LD	SSOP-B16
BH2221FV	2.7 to 5.5	12	1.6	±1.0	±1.5	±1.0	10	CMOS	LD	SSOP-B20

10bit

10bit Resolution										
Part No.	Supply Voltage (V)	CH	Current Consumption (mA)	DNL (LSB)	INL (LSB)	Load Current (mA)	Data Transfer Clock Frequency (MHz)	Input Type	Data Latch Method	Package
BU2508FV	4.5 to 5.5	4	4.5	±1.0	±3.5	±2.0	10	TTL	LD	SSOP-B14
BU2507FV	4.5 to 5.5	6	4.5	±1.0	±3.5	±2.0	10	TTL	LD	SSOP-B14
BU2506FV	4.5 to 5.5	8	4.5	±1.0	±3.5	±2.0	10	TTL	LD	SSOP-B20
BU2505FV	4.5 to 5.5	10	4.5	±1.0	±3.5	±2.0	10	TTL	LD	SSOP-B20
New BU22210MUV	2.7 to 5.5	10	1.2	±0.5	±2.0	±1.0	10	TTL	CSB	VQFN016V3030



ICs

Interface

CONTENTS

LVDS Interface ICs	P. A28
Clockless Link Interface ICs	P. A28
Timing Controllers	P. A28
Multiple Input Switch Monitor LSIs	P. A29
22ch Models	P. A29
33ch Models	P. A29
10ch Models	P. A29
IrDA Controllers	P. A29
LIN Transceivers	P. A29
LIN Transceiver	P. A29
CXPI Transceiver	P. A29
CXPI Transceiver	P. A29
PLC(Power Line Communication)	P. A29
HD-PLC Inside Compliant Baseband IC	P. A29
Broadband Power Line Communication Baseband IC	P. A29
USB Type-C Power Delivery	P. A30
USB Type-C Power Delivery Controllers	P. A30
For POWER SOURCE	P. A30
For POWER SOURCE & SINK	P. A30
For POWER SINK	P. A30

LVDS Interface ICs

A
Interface

27bit LVDS Transmitter 27:4 Serializer									
Part No.	Type	bits (bit)	Color Depth	Input Specification	Output Specification	Clock Frequency (MHz)	Supply Voltage (V)	Operating Temperature (°C)	Package
BU90T81	Serializer	27	8	LVC MOS	LVDS Single Link	20 to 112	1.65 to 1.95	-20 to +85	VBGA048W040
27bit LVDS Transmitter 27:8 Serializer									
BU90T82	Serializer	27	8	LVC MOS	LVDS Dual Link	10 to 174	1.62 to 1.98 1.62 to 3.6	-40 to +85	SBGA072T070A
35bit LVDS Transmitter 35:5 Serializer									
BU8254KVT	Serializer	35	10	LVC MOS	LVDS Single Link	8 to 112	3.0 to 3.6	-40 to +85	TQFP64V
BU8254GUW	Serializer	35	10	LVC MOS	LVDS Single Link	8 to 112	3.0 to 3.6	-20 to +85	VBGA099W060
56bit LVDS Transmitter 56:8 Serializer									
BU7988KVT	Serializer	56	8	LVC MOS	LVDS Dual Link	8 to 112	3.0 to 3.6	-20 to +85	TQFP100V
35bit LVDS Receiver 5:35 Deserializer									
BU90R104	Deserializer	35	10	LVDS Single Link	LVC MOS	8 to 112	2.3 to 3.6	-40 to +85	TQFP64V
56bit LVDS Receiver 8:56 Deserializer									
BU7985KVT	Deserializer	56	8	LVDS Dual Link	LVC MOS	20 to 112	3.0 to 3.6	-20 to +85	TQFP100V
67bit LVDS Receiver 10:67 Deserializer									
BU90R102	Deserializer	67	10	LVDS Dual Link	LVC MOS	8 to 160	2.3 to 3.6	-40 to +85	HQFP144VM
70bit LVDS Distributor									
BU90RT102	Serializer Deserializer	70	10	LVDS	LVDS	20 to 135	3.0 to 3.6	-20 to +85	HTSSOP-C64
4bit LVDS Driver									
BU90LV047A	Driver	4	—	LVC MOS	LVDS	250	3.0 to 3.6	-40 to +85	SSOP-B16
4bit LVDS Receiver									
BU90LV048	Receiver	4	—	LVDS	LVC MOS	250	3.0 to 3.6	-40 to +85	SSOP-B16
4bit LVDS Transceiver									
BU90LV049A	Transceiver	4	—	LVC MOS/LVDS	LVC MOS/LVDS	250	3.0 to 3.6	-40 to +85	SSOP-B16

Clockless Link Interface ICs

Clockless Link Serializer/Deserializer											
Part No.	Type	Input Specification	Output Specification	No. of Rx	No. of Tx	Clock Frequency (MHz)	Clockless Transfer Rates (Gbps)	Parallel BUS Width (bit)	Supply Voltage (V)	Operating Temperature (°C)	Package
BU17074KV	Serializer Deserializer	LVC MOS/ Clockless Link	Clockless Link/ LVC MOS	—/1	1/—	20 to 75	2.7	28	2.3 to 3.6	-40 to +85	VQFP64
BU17101AKV-M	Serializer	LVC MOS	Clockless Link	—	1	30 to 51	1.63	24	2.3 to 3.6	-40 to +85	VQFP48
BU17102AKV-M	Deserializer	Clockless Link	LVC MOS	1	—	30 to 51	1.63	24	2.3 to 3.6	-40 to +85	VQFP48

Timing Controllers

Timing Controller for FHD, WUXGA									
Part No.	Supply Voltage (V)	Input Specification	Output Specification	Input bits (bit)	Output bits (bit)	Clock Frequency (MHz)	Resolution	Operating Temperature (°C)	Package
BU90AM4-03	1.2/1.8/1.8 to 3.3	MIPI DSI 4 lane	iSP 8 lane	8/6	8/6	200	1,920×1,200	-20 to +70	UQFN54
BU8179MWV	1.2/1.8/3.3	eDP1.2 2 lane	iSP 6 lane	8/6	8/6	200	1,920×1,280	-20 to +85	UQFN46
BU90AD2-01	1.2/1.8/3.3	eDP1.2 2 lane	iSP 8 lane	8/6	8/6	170	1,920×1,280	-40 to +85	UQFN54
BM91AD2-01	1.2/1.8/3.3	eDP1.3 2 lane	iSP 8 lane	8/6	8/6	160	1,920×1,280	-20 to +85	UQFN60
New BU90AL210-M	1.5/3.3	LVDS Dual	mini-LVDS 6pair Dual	8/6	8/6	240	2,880×1,080	-40 to +105	HTQFP100V
New BU90AL211-M	1.5/3.3	LVDS Dual	mini-LVDS 6pair Single	8/6	8/6	180	1,920×1,080	-40 to +105	UQFP80

Multiple Input Switch Monitor LSIs

22ch Models									
Part No.	Supply Voltage (V)	Switch Input Number	Switch Input Voltage Range (V)	Wetting Current (mA)	Operating Current Intermittent Monitoring 50ms(Max.)	Control I/F	Clock Frequency (MHz)	Operating Temperature (°C)	Package
BD3375MUV-M	8.0 to 26 (VPUA/VPUB) 3.1 to 5.25 (VDDI)	22	-14 to +40	1/3/5/10/15(Pull up/Pull down)	100μA	SPI	up to 4.4	-40 to +125	VQFN48MVCV070
BD3375KV-C	8.0 to 26 (VPUA/VPUB) 3.1 to 5.25 (VDDI)	22	-14 to +40	1/3/5/10/15(Pull up/Pull down)	100μA	SPI	up to 4.4	-40 to +125	VQFP48C
33ch Models									
BD3377MUV-M	6.0 to 28 (VPUA/VPUB) 3.1 to 5.25 (VDDI)	33	-14 to +40	1/3/5/10/15 (Pull up/Pull down)	110μA	SPI	up to 4.4	-40 to +125	VQFN48MDV070
New BD3377EKV-C	6.0 to 28 (VPUA/VPUB) 3.1 to 5.25 (VDDI)	33	-14 to +40	1/3/5/10/15 (Pull up/Pull down)	110μA	SPI	up to 4.4	-40 to +125	HTQFP64BV
10ch Models									
BD3376MUV-M	8.0 to 26 (VPUA/VPUB) 3.1 to 5.25 (VDDI)	10	-14 to +40	1/3/5/10/15(Pull up/Pull down)	100μA	SPI	up to 4.4	-40 to +125	VQFN28SV5050
BD3376EFV-C	8.0 to 26 (VPUA/VPUB) 3.1 to 5.25 (VDDI)	10	-14 to +40	1/3/5/10/15(Pull up/Pull down)	100μA	SPI	up to 4.4	-40 to +125	HTSSOP-B30

IrDA Controllers

IrDA SIR Encoder/Decoder						
Part No.	Supply Voltage(V)		Data Rate (bps)	Clock Frequency (Hz)	I/F	Package
	V _{DD}	V _{IO}				
BU92001KN	2.50 to 3.50	—	2.4k to 115.2k	24M to 29.5M	UART	VQFN20
IrDA SIR, MIR, FIR, IrSimple Controllers/Remote Control Transmitters						
BU92747GUW	1.62 to 1.98	1.62 to 3.60	2.4k to 115.2k, 0.576M, 1.152M, 4M	48M	Parallel BUS (16bit)	VBGA048W040
BU92747KV	1.62 to 1.98	1.62 to 3.60	2.4k to 115.2k, 0.576M, 1.152M, 4M	48M	Parallel BUS (16bit)	VQFP48C

LIN Transceivers

LIN Transceivers								
Part No.	Supported Standards	Supply Voltage (V)	Operating Temperature (°C)	Absolute Maximum Rating of LIN pin (V)	Baud Rates (kbps)	Supply Current at Sleep Mode (μA)	Package	Automotive Grade AEC-Q100
BD41030FJ-C	LIN2.0, LIN2.1, LIN2.2, LIN 2.2A	5 to 27	-40 to +125	-27 to +40	20(Max.)	3 (Typ.)	SOP-J8	YES
New BD41030HFN-C	LIN2.0, LIN2.1, LIN2.2, LIN 2.2A	5 to 27	-40 to +125	-27 to +40	20(Max.)	3 (Typ.)	HSO8	YES

CXPI Transceiver

CXPI Transceiver								
Part No.	Supported Standards	Supply Voltage (V)	Operating Temperature (°C)	Absolute Maximum Rating of BUS (V)	Baud Rates (kbps)	Supply Current at Sleep Mode (μA)	Package	Automotive Grade AEC-Q100
New BD41000AFJ-C	JASO_D015_3	7 to 18	-40 to +125	-27 to +40	5 to 20	3(Typ.)	SOPJ-8	YES

PLC(Power Line Communication)

HD-PLC Inside Compliant Baseband IC											
Part No.	Supported Standards	Operating Frequency Band	Supply Voltage (V)	Modulation Method	FEC Mode	Control I/F	Communication Speed	Transmission Output	Receiving Sensitivity	Operating Temperature (°C)	Package
BU82204MWV	HD-PLC inside	2 to 28MHz	1.45 to 1.55 3.0 to 3.6	Wavelet OFDM	AES128	UART or SPI	up to 3Mbps	-10dBm/10KHz	-88dBm/10KHz	-40 to +85	UQFN88MV0100
Broadband Power Line Communication Baseband IC											
BU82205MWV	ROHM Original PLC	2 to 28MHz	1.45 to 1.55 3.0 to 3.6	Wavelet OFDM	AES128	UART or SPI	up to 3Mbps	-10dBm/10KHz	-88dBm/10KHz	-40 to +85	UQFN88MV0100

USB Type-C Power Delivery

USB Type-C Power Delivery Controllers

For POWER SOURCE (POWER Role:Source, DATA Role:DFP, Variable OCP, Variable OVP, Internal Vconn SW)

Part No.	Supply Voltage (V)	IO Supply Voltage (V)	TYPE-C/PD Controller	Initial Supply Capable Voltage/Current (V/A)	Tolerant Voltage at CC Pins(V)	Gate Drivers for Nch FET	After OCP Behavior After OVP Behavior	DP Alternate Mode	Internal Shunt Reg.	Operating Temperature (°C)	Package	
New BM92A20MWV	3.1 to 20	1.7 to 5.5	✓/✓	5/3, 12/3, 15/3, 16/2.8, 19/2.36, 19.6/2.29, 20/2.25	6	For Source: 1pair	OCP: Automatic recovery OVP: Automatic recovery	—	—	-30 to +105	UQFN40V5050A	
New BM92A21MWV				5/3, 9/3, 15/3, 20/3		For Source: 1pair	OCP: Automatic recovery OVP: Automatic recovery				✓	UQFN40V5050A
☆BM92A26MWV				5/2.4, 14.8/2		For Source: 1pair	OCP: Automatic recovery OVP: Automatic recovery				—	UQFN40V5050A
New BM92A50MWV				5/0.5, 12 to 20 Variable/ 2.25		For Source: 2pair	OCP: Automatic recovery OVP: Automatic recovery				—	UQFN40V5050A
New BM92A56MWV				Variable PDO18W, 27W, 45W, 60W		For Source: 2pair	OCP: Automatic recovery OVP: Automatic recovery				—	UQFN40V5050A
☆BM92A70MWV				5/0.5, 12 to 20 Variable/ 2.25		For Source: 2pair	OCP: Automatic recovery OVP: Automatic recovery				DP_SINK Auto	UQFN40V5050A
☆BD93W20F				4.75 to 20		—	✓/✓				5/3, 9/3, 15/3, 20/3	25.2
☆BD93W26F	5/3, 9/3, 12/3, 15/3, 20/3	25.2	For Source: 1Driver		OCP: Automatic recovery OVP: Automatic recovery			—	✓	—	—	SOP16

For POWER SOURCE & SINK (POWER Role:Source/Sink, DATA Role:DRP)

Part No.	Supply Voltage (V)	IO Supply Voltage (V)	TYPE-C/PD Controller	Connected The Required Initial Voltage(V) Dead Battery	Non Dead Battery	Gate Drivers for Nch FET	Internal Vconn SW	DP Alternate Mode	Internal Shunt Reg.	Operating Temperature (°C)	Package
BM92A30MWV	3.1 to 20	1.7 to 5.5	✓/✓	5, 12 to 20 Variable Depends on the opposite side	5	For Sink: 1pair For Source: 1pair	✓	DP_SOURCE	—	-30 to +105	UQFN40V5050A

For POWER SINK (POWER Role:Sink, DATA Role:UFP)

Part No.	Supply Voltage (V)	IO Supply Voltage (V)	TYPE-C/PD Controller	Connected The Required Initial Voltage(V) Without Ext-MCU	Start of Automatic Power Receiving Without Ext-MCU	Gate Drivers for Nch FET	Internal Vconn SW	DP Alternate Mode	Internal Shunt Reg.	Operating Temperature (°C)	Package
New BM92A11MWV	3.1 to 20	1.7 to 5.5	✓/✓	5, 12	✓	For Sink: 1pair For Source: 1pair	✓	—	—	-30 to +105	UQFN40V5050A
New BM92A12MWV				5, 20							UQFN40V5050A
New BM92A13MWV				5, 15							UQFN40V5050A
New BM92A14MWV				5, 9							UQFN40V5050A
New BM92A15MWV				5 to 20 Depends on the opposite side							UQFN40V5050A
☆BM92A31MWV				5, 12							UQFN40V5050A
☆BM92A32MWV				5, 20							UQFN40V5050A
☆BM92A33MWV				5, 15							UQFN40V5050A
☆BM92A34MWV				5, 9							UQFN40V5050A
☆BM92A35MWV				5 to 20 Variable							UQFN40V5050A

☆ : Under Development



Power Management

CONTENTS

Linear Regulators	P. A32
78 Series Regulators	P. A33
Single-Output LDO Regulators	P. A33
LDO Regulators with Voltage Detector and Watchdog Timer	P. A46
LDO Regulators with Voltage Detector	P. A46
Voltage Tracker	P. A46
Multi-Output LDO Regulators	P. A47
Linear Regulators for DDR SDRAM	P. A47
Switching Regulators	P. A48
Integrated MOSFET Switching Regulators	P. A49
External Switch Switching Regulators	P. A51
For Automotive Switching Regulators	P. A52
Digital Controllers(Powervation) Series	P. A53
Digital Controllers for Servers/ Base Stations(Powervation)	P. A53
Switching Regulators (System Power Supplies)	P. A54
System Power Supply ICs for Car Audio	P. A55
System Power Supply ICs for LCD Panels	P. A55
Programmable Gamma-Voltage Generator/Gamma Buffer Amp.	P. A55
System Power Supply ICs for Mobile Phones	P. A56
System Power Supply ICs for DSC/DVCs	P. A56
System Power Supply ICs for Automotive	P. A57
System Power Supply ICs for Industrial/Consumer Applications	P. A57
Isolated/No Isolated Power Supply	P. A57
AC/DC Converter ICs	P. A57
Isolated DC/DC Converter ICs	P. A59
Isolated DC/DC Controller	P. A59
Gate Drivers	P. A59
Isolated Gate Drivers	P. A59
Others	P. A59
IGBT/MOSFET High-side Low-side Gate Drivers	P. A59
IGBT/MOSFET High-side Low-side 3 Phase Bridge Driver	P. A59
High Voltage Monitor	P. A59
Isolated High Voltage Monitor	P. A59
Temperature Monitor	P. A59
Isolated Temperature Monitor	P. A59
Power Management Switch	P. A60
1 Channel Compact High Side Switch ICs	P. A60
1 Channel High Side Switch ICs	P. A61
2 Channel High Side Switch ICs	P. A61
Load Switch ICs	P. A62
Load Switch ICs(Industrial Equipment)	P. A62
1 Channel Compact High Side Load Switch ICs	P. A62
2 Channel Compact High Side Load Switch IC	P. A62
Controller IC for High Side NMOSFET	P. A62
Controller IC for High Side NMOSFET(Industrial Equipment)	P. A62
Wireless Power	P. A62
Receiver ICs	P. A62
Transmitter ICs	P. A62
Power Receiver LSI(LAPIS Semiconductor products)	P. A62
Power Transmitter LSI(LAPIS Semiconductor products)	P. A62
Battery Management	P. A63
Battery Charger ICs	P. A63
Solar Charge Management IC	P. A63
Charge Protection ICs	P. A63
Cell Balance IC of Power Storage Element Cells	P. A63
Li-ion Battery Monitoring LSIs(LAPIS Semiconductor products)	P. A63
Voltage Detectors(Reset ICs)	P. A64
Voltage Detectors(Reset ICs)	P. A64
Voltage Detectors with Adjustable Delay Time	P. A65
Voltage Detectors with Built-in Delay Time	P. A65
Voltage Detectors for Automotive	P. A66
Others	P. A66
Voltage Detectors with Watchdog Timer	P. A66
Composite type Voltage Detectors(2ch+Comparator)	P. A66

General-purpose ICs

Linear Regulators

Linear Regulators

78 Series Regulators ▶ P.A33

Single-Output LDO Regulators ▶ P.A33

LDO Regulators with Voltage Detector and Watchdog Timer ▶ P.A46

LDO Regulators with Voltage Detector ▶ P.A46

Voltage Tracker ▶ P.A46

Multi-Output LDO Regulators ▶ P.A47

Linear Regulators for DDR SDRAM ▶ P.A47

Single-Output LDO Regulators - Product Table

Max. Output Current / Refng. Input Voltage	0.1A	0.15A	0.2A	0.3A	0.5A	1.0A	1.5A	2.0A	3.0A	4.0A	External MOSFET
45 to 50V	BD42500G-C*2/3 BD42540FJ-C*2/3 ▶P.A46		BD7xxL2*2 BD4xxM2*1/2 ▶P.A34 BD3010AFV*2/3 BD4269FJ-C*2/3 BD42530EFJ-C*2 BD42530FP2-C*2 BD42530FPJ-C*2 ▶P.A46	BD4269EFJ-C*2/3 ▶P.A46	BD357XY*2 BD7xxL5FP-C*2 BD4xxM5*1/2 BD4xxM5W*1/2 ▶P.A33, A34 BD4271HFP-C*2/3 BD4271FP2-C*2/3 BD3021HFP*2/3 BD3020HFP*2/3 BD4275HFPJ-C*2/3 BD42754FP2-C*2/3 BD3925FP-C*2 BD3925HFP-C*2 ▶P.A46						
30 to 36V	BDxxFA1FP3*2 BD50FA1MG-M*2 BD00FA1WEFJ ▶P.A36			BD3650FP-M*2 BA3662CP-V5 ▶P.A34, A36	BA178Mxx*1 ▶P.A33	BA178xx*1 BAxxCC0*1 BDxxC0AFPS BDxxFC0FP BDxxC0A*1/2 BDxxFC0W*1 BAxxCC0W*1 BD00C0AWFP-M*2 BDxxC0AW*1/2 ▶P.A33, A35, A36		BAxxDD0W*1 BAxxDD0W*1 BDxxFD0WHFP BDxxFD0WHFP ▶P.A34			
18V						BAxxBC0*1 BAxxBC0W*1 ▶P.A36, A37	BAxxJC5T BA00JC5WT ▶P.A36				
15V				BDxxGA3*1/2/4 ▶P.A38, A39	BDxxGA5*2/4 ▶P.A38	BA1117FP BDxxGC0*2/4 ▶P.A33, A37					
10V				BDxxHA3*2/4 ▶P.A41	BDxxHA5*2/4 ▶P.A40	BDxxHC0*2/4 ▶P.A40	BDxxHC5*2/4 ▶P.A39				
6 to 7V	BHxxNB1WHFV BHxxRB1WGUT BHxxPB1WHFV BHxxSA3WGUT ▶P.A45	BUxxTD2WNVX*1 BUxxTD3WG*1 BUxxTA2W*1 BUxxSD2MG-M*2 BUxxJA2MNVX-C*2 BUxxJA2VG-C*2 BUxxJA2DG-C*2 BUxxSA4WGWL ▶P.A44, A45	BHxxM0AWHFV ▶P.A43	BDxxIA5*2/4 BDxxKA5FP BDxxKA5W*1 BUxxSD5WG BUxxSASWGWZ ▶P.A42	BDxxIC0*1/2/4 ▶P.A41						
Ultra Low Voltage (Dual Supply)					BD3550HFN BD3507HFV BD3540NUV BD37201NUX ▶P.A46	BD3551HFN BD3541NUV BD37210MUV BD37215MUV ▶P.A46	BD3506F BD3552HFN ▶P.A46	BD3508MUV BD3512MUV ▶P.A46	BD3509MUV ▶P.A46	BD3504FVM BD3521FVM ▶P.A46	

*1 : Package Lineup *2 : Automotive Grade *3 : Multi Function Regulator (Ex. Voltage Detection) *4 : Industrial Grade

Linear Regulators

Please ensure that minimum Input Voltage always exceeds the sum of Output Voltage and drop out voltage for the device.

78 Series Regulators

35V Resistance 1A Output 78 Series Regulators										
Type	Input Voltage (V)	Output Voltage (V)	Output Voltage Precision(%)	Output Current (A)	Circuit Current (mA)	Thermal Shutdown Circuit	Area of Safety Operation Circuit	Over Current Protection Circuit	Package/Part No.	
									TO220CP-3	TO252-3
BA7805	7.5 to 25.0	5	±4	1	4.5	✓	✓	✓	BA7805CP	BA7805FP
BA7806	8.5 to 21.0	6							BA7806CP	BA7806FP
BA7807	9.5 to 22.0	7							BA7807CP	BA7807FP
BA7808	10.5 to 23.0	8							BA7808CP	BA7808FP
BA7809	11.5 to 26.0	9							BA7809CP	BA7809FP
BA7810	12.5 to 25.0	10							BA7810CP	BA7810FP
BA7812	15.0 to 27.0	12							BA7812CP	BA7812FP
BA7815	17.5 to 30.0	15							BA7815CP	BA7815FP
BA7818	21.0 to 33.0	18							BA7818CP	BA7818FP
BA7820	23.0 to 33.0	20							BA7820CP	BA7820FP
BA7824	27.0 to 33.0	24							BA7824CP	BA7824FP

35V Resistance 500mA Output 78 Series Regulators										
Type	Input Voltage (V)	Output Voltage (V)	Output Voltage Precision(%)	Output Current (A)	Circuit Current (mA)	Thermal Shutdown Circuit	Area of Safety Operation Circuit	Over Current Protection Circuit	Package/Part No.	
									TO220CP-3	TO252-3
BA78M05	7.5 to 25.0	5	±4	0.5	4.5	✓	✓	✓	BA78M05CP	BA78M05FP
BA78M06	8.5 to 21.0	6							BA78M06CP	BA78M06FP
BA78M07	9.5 to 22.0	7							BA78M07CP	BA78M07FP
BA78M08	10.5 to 23.0	8							BA78M08CP	BA78M08FP
BA78M09	11.5 to 26.0	9							BA78M09CP	BA78M09FP
BA78M10	12.5 to 25.0	10							BA78M10CP	BA78M10FP
BA78M12	15.0 to 27.0	12							BA78M12CP	BA78M12FP
BA78M15	17.5 to 30.0	15							BA78M15CP	BA78M15FP
BA78M18	21.0 to 33.0	18							BA78M18CP	BA78M18FP
BA78M20	23.0 to 33.0	20							BA78M20CP	BA78M20FP
BA78M24	27.0 to 33.0	24							BA78M24CP	BA78M24FP

15V Resistance 1A Output 78 Series Regulator										
Part No.	Input Voltage (V)	Output Voltage (V)	Output Voltage Precision(%)	Output Current (A)	Adjustment Pin Current (μA)	Reference Voltage (V)	Ripple Rejection (dB)	Load Regulation (mV)	Protection Circuit	Package
BA1117FP	10	Variable	± 1	1	60	1.2 (I _o =1A)	75 (f=120Hz V _i -V _o =3V Ripple=1Vpp)	10	Over-Current/ Temperature	TO252-3

1A Output 78 Series Regulators : UNIVERSAL STANDARD SPECIFICATION
500mA Output 78 Series Regulators : UNIVERSAL STANDARD SPECIFICATION

Single-Output LDO Regulators

50V Resistance Output 500mA LDO Regulators																					
Part No.	Input Voltage (V)	Output Voltage (V)	Output Voltage Precision(%)	Output Current (A)	Saturation Voltage: I _o =200mA(V)	Circuit Current (μA)	Operating Temperature (°C)	Shutdown Switch	Protection Circuit	Package	Automotive Grade AEC-Q100										
BD3570YFP-M	4.5 to 36.0	3.3	± 2 (T _a = - 40 to + 125°C)	0.5	—	30	- 40 to + 125	—	Over-Current/ Temperature	TO252-3	Preparing										
BD3570YHFP-M										HRP5	Preparing										
BD3571YFP-M	5.5 to 36.0	5.0								0.25	30	- 40 to + 125	—	Over-Current/ Temperature	TO252-3	Preparing					
BD3571YHFP-M															HRP5	Preparing					
BD3572YFP-M	4.5 to 36.0	Variable 2.8 to 12.0													0.25	30	- 40 to + 125	—	Over-Current/ Temperature	TO252-5	Preparing
BD3572YHFP-M		HRP5																		Preparing	
BD3573YFP-M		3.3			TO252-5	Preparing															
BD3573YHFP-M		HRP5			Preparing																
BD3574YFP-M	5.5 to 36.0	5.0			0.25	30	- 40 to + 125	✓	Over-Current/ Temperature	TO252-5	Preparing										
BD3574YHFP-M										HRP5	Preparing										
BD3575YFP-M	4.5 to 36.0	Variable 2.8 to 12.0								0.25	30	- 40 to + 125	✓	Over-Current/ Temperature	TO252-5	Preparing					
BD3575YHFP-M															HRP5	Preparing					

A Power Management

Single-Output LDO Regulators

Please ensure that minimum Input Voltage always exceeds the sum of Output Voltage and drop out voltage for the device.

50V Resistance Output Low Quiescent Current 200mA LDO Regulators

Part No.	Input Voltage (V)	Output Voltage (V)	Output Voltage Precision(%)	Output Current (A)	Saturation Voltage : $I_o=200mA(V)$	Circuit Current (μA)	Operating Temperature (°C)	Shutdown Switch	Protection Circuit	Package	Automotive Grade AEC-Q100
BD733L2EFJ-C	4.37 to 45.0	3.3	± 2 ($T_a = -40$ to $+125^\circ C$)	0.2	0.6	6.0	-40 to +125	—	Over-Current/ Temperature	HTSOP-J8	YES
BD750L2EFJ-C	5.8 to 45.0	5.0			0.4					HTSOP-J8	YES
BD733L2FP-C	4.37 to 45.0	3.3			0.6					TO252-3	YES
BD733L2FP3-C	4.37 to 45.0	3.3			0.6					SOT223-4	YES
BD750L2FP-C	5.8 to 45.0	5.0			0.4					TO252-3	YES
BD750L2FP3-C	5.8 to 45.0	5.0			0.4					SOT223-4	YES

50V Resistance Output Low Quiescent Current 500mA LDO Regulators

Part No.	Input Voltage (V)	Output Voltage (V)	Output Voltage Precision(%)	Output Current (A)	Saturation Voltage : $I_o=200mA(V)$	Circuit Current (μA)	Operating Temperature (°C)	Shutdown Switch	Protection Circuit	Package	Automotive Grade AEC-Q100
BD733L5FP-C	4.17 to 45.0	3.3	± 2 ($T_a = -40$ to $+125^\circ C$)	0.5	0.4	6.0	-40 to +125	—	Over-Current/ Temperature	TO252-3	YES
BD750L5FP-C	5.6 to 45.0	5.0			0.25					TO252-3	YES

45V Resistance Output Low Quiescent Current 500mA LDO Regulators

Type	Input Voltage (V)	Output Voltage (V)	Output Voltage Precision(%)	Output Current (A)	I/O Voltage Difference (V)	Circuit Current (μA)	Operating Temperature (°C)	Shutdown Switch	Protection Circuit	Package/Part No.				Automotive Grade AEC-Q100
										TO252-3	TO263-3	TO263-5	TO252-J5	
BD433M5	4.0 to 42.0	3.3	± 2 ($T_j = -40$ to $+150^\circ C$)	0.5	0.25 ($I_o=300mA$)	38	-40 to +150°C	—	Over-Current/ Temperature	BD433M5FP-C	BD433M5FP2-C	—	—	YES
BD450M5	5.5 to 42.0	5.0			0.2 ($I_o=300mA$)					BD450M5FP-C	BD450M5FP2-C	—	—	YES
BD433M5W	4.0 to 42.0	3.3			0.25 ($I_o=300mA$)					—	—	BD433M5WFP2-C	BD433M5WFPJ-C	YES
BD450M5W	5.5 to 42.0	5.0			0.2 ($I_o=300mA$)					—	—	BD450M5WFP2-C	BD450M5WFPJ-C	YES

45V Resistance Output Low Quiescent Current 200mA LDO Regulators

Type	Input Voltage (V)	Output Voltage (V)	Output Voltage Precision(%)	Output Current (A)	I/O Voltage Difference (V)	Circuit Current (μA)	Operating Temperature (°C)	Shutdown Switch	Protection Circuit	Package/Part No.		Automotive Grade AEC-Q100
										HTSOP-J8	SOT223-4	
BD433M2	3.9 to 42.0	3.3	± 2 ($T_j = -40$ to $+150^\circ C$)	0.2	0.2 ($I_o=100mA$)	40	$T_j = -40$ to $+150$	—	Over-Current/ Temperature	BD433M2EFJ-C	BD433M2FP3-C	YES
BD450M2	5.5 to 42.0	5.0			0.16 ($I_o=100mA$)					BD450M2EFJ-C	BD450M2FP3-C	YES
BD433M2W	3.9 to 42.0	3.3			0.2 ($I_o=100mA$)					BD433M2WEFJ-C	BD433M2WFP3-C	YES
BD450M2W	5.5 to 42.0	5.0			0.16 ($I_o=100mA$)					BD450M2WEFJ-C	BD450M2WFP3-C	YES

36V Resistance Output 300mA LDO Regulator

Part No.	Input Voltage (V)	Output Voltage (V)	Output Voltage Precision(%)	Output Current (A)	I/O Voltage Difference (V)	Circuit Current (mA)	Operating Temperature (°C)	Protection Circuit	Package	Automotive Grade AEC-Q100
BD3650FP-M	5.6 to 30.0	5.0	± 2 ($T_a = -40$ to $+125^\circ C$)	0.3	0.2 ($I_o=200mA$)	0.5	-40 to +125	Over-Current/ Temperature	TO252-3	YES

35V Resistance 2A LDO Regulators

Part No.	Input Voltage (V)	Output Voltage (V)	Output Voltage Precision(%)	Output Current (A)	Bias Current (mA)	I/O Voltage Difference (V)	Ripple Rejection (dB)	Load Regulation (mV)	Protection Circuit	Package
BA15DD0T	3 to 25	1.5	± 1.0	2.0	0.9	0.45 ($I_o=2A$)	55	50 ($I_o=0A$ to 2A)	Over-Voltage/ Over-Current/ Temperature	TO220FP-3
BA18DD0T		1.8								TO220FP-3
BA25DD0T		2.5								TO220FP-3
BA30DD0T		3.0								TO220FP-3
BA33DD0T		3.3								TO220FP-3
BA50DD0T		5.0								TO220FP-3
BA90DD0T		9.0								TO220FP-3
BAJ2DD0T		12.0								TO220FP-3
BAJ6DD0T		16.0								TO220FP-3

35V Resistance 2A LDO Regulators with Shutdown Switch

Type	Input Voltage (V)	Output Voltage (V)	Output Voltage Precision(%)	Output Current (A)	Bias Current (mA)	I/O Voltage Difference (V)	Ripple Rejection (dB)	Load Regulation (mV)	Protection Circuit	Package/Part No.	
										TO220FP-5	HRP5
BA00DD0W	3 to 25	Variable 1.5 to 16.0	± 1.0	2.0	0.9	0.45 ($I_o=2A$)	55	50 ($I_o=0A$ to 2A)	Over-Voltage/ Over-Current/ Temperature	BA00DD0WCP-V5 (TO220CP-V5)	BA00DD0WHFP
BA15DD0W		1.5								BA15DD0WHFP	
BA18DD0W		1.8								BA18DD0WHFP	
BA25DD0W		2.5								BA25DD0WHFP	
BA30DD0W		3.0								BA30DD0WHFP	
BA33DD0W		3.3								BA33DD0WHFP	
BA50DD0W		5.0								BA50DD0WHFP	
BA90DD0W		9.0								BA90DD0WHFP	
BAJ2DD0W		12.0								BAJ2DD0WHFP	
BAJ6DD0W		16.0								BAJ6DD0WHFP	

Part No.	Input Voltage (V)	Output Voltage (V)	Output Voltage Precision(%)	Output Current (A)	Bias Current (mA)	I/O Voltage Difference (V)	Ripple Rejection (dB)	Load Regulation (V)	Protection Circuit	Package
BD00D0AWHFP	4.0 to 26.5	3.0 to 15.0	± 1.0	2.0	0.5	0.4 ($I_o=1A$)	55	$V_o \times 0.7\%$ ($I_o=5mA$ to 1A)	Over-Current/ Temperature	HRP5
BD00FD0WHFP	4.0 to 32.0	Variable 1.5 to 16.0	± 1.0	2.0	0.5	0.4 ($I_o=1A$)	55	$V_o \times 2.0\%$ ($I_o=5mA$ to 1A)		HRP5
BD15FD0WHFP		1.5				HRP5				
BD18FD0WHFP		1.8				HRP5				
BD25FD0WHFP		2.5				HRP5				
BD30FD0WHFP	3.0	HRP5								
BD33FD0WHFP	3.3	HRP5								
BD50FD0WHFP	5.0	HRP5								
BD80FD0WHFP	8.0	HRP5								
BD90FD0WHFP	9.0	HRP5								
BDJ2FD0WHFP	12.0	HRP5								
BDJ5FD0WHFP	15.0	HRP5								
BDJ6FD0WHFP	16.0	HRP5								

Power Management

Please ensure that minimum input voltage always exceeds the sum of Output Voltage and drop out voltage for the device.

35V Resistance 1A LDO Regulators													
Type	Input Voltage (V)	Output Voltage (V)	Output Voltage Precision(%)	Output Current (A)	Bias Current (mA)	I/O Voltage Difference (V)	Ripple Rejection (dB)	Load Regulation (mV)	Protection Circuit	Package/Part No.			
										TO220FP-3	TO252-3		
BA03CC0	4 to 25	3.0	±2.0	1.0	2.5	0.30 (I _o =0.5A)	55	50 (I _o =5mA to 1A)	Over-Voltage/Over-Current/Temperature	BA03CC0T	BA03CC0FP		
BA033CC0		3.3								BA033CC0T	BA033CC0FP		
BA05CC0		5.0								BA05CC0T	BA05CC0FP		
BA06CC0		6.0								—	BA06CC0FP		
BA07CC0		7.0								BA07CC0T	BA07CC0FP		
BA08CC0		8.0								BA08CC0T	BA08CC0FP		
BA09CC0		9.0								BA09CC0T	BA09CC0FP		
BAJ0CC0		10.0								BAJ0CC0T	BAJ0CC0FP		
BAJ2CC0		12.0								BAJ2CC0T	BAJ2CC0FP		
BAJ5CC0		15.0								BAJ5CC0T	BAJ5CC0FP		
Part No.	Input Voltage (V)	Output Voltage (V)	Output Voltage Precision(%)	Output Current (A)	Bias Current (mA)	I/O Voltage Difference (V)	Ripple Rejection (dB)	Load Regulation (mV)	Protection Circuit	Package			
BD80C0AFPS	9.0 to 26.5	8.0	±1.0	1.0	0.6	0.30 (I _o =0.5A)	50	Vo × 0.01 (I _o =5mA to 1A)	Over-Current/Temperature	TO252S-3			
BD90C0AFPS	10.0 to 26.5	9.0											
BD33FC0FP	4.3 to 26.5	3.3	±1.0	1.0	0.6	—	55	Vo × 0.01 (I _o =5mA to 1A)	Over-Current/Temperature	TO252S-3			
BD50FC0FP	6.0 to 26.5	5.0								0.30(I _o =0.5A)			
Type	Input Voltage (V)	Output Voltage (V)	Output Voltage Precision(%)	Output Current (A)	Bias Current (mA)	I/O Voltage Difference (V)	Ripple Rejection (dB)	Load Regulation (mV)	Protection Circuit	Package/Part No.		Automotive Grade AEC-Q100	
BD33C0A	4.3 to 26.5	3.3	±3.0 (Ta= -40 to +125° C)	1.0	0.5	0.3 (I _o =500mA)	55	Vo × 0.01 (I _o =5mA to 1A)	Over-Current/Temperature	TO252-3	HRP5	TO263-3	YES
BD50C0A	6.0 to 26.5	5.0								BD33C0AFP-C	BD33C0AHFP-C	BD33C0AFP2-C	YES
BD80C0A	9.0 to 26.5	8.0								BD50C0AFP-C	BD50C0AHFP-C	BD50C0AFP2-C	YES
BD90C0A	10.0 to 26.5	9.0								BD80C0AFP-C	BD80C0AHFP-C	BD80C0AFP2-C	YES
BD90C0A	10.0 to 26.5	9.0	BD90C0AFP-C	BD90C0AHFP-C	BD90C0AFP2-C	YES							
35V Resistance 1A LDO Regulators with Shutdown Switch													
Type	Input Voltage (V)	Output Voltage (V)	Output Voltage Precision(%)	Output Current (A)	Bias Current (mA)	I/O Voltage Difference (V)	Ripple Rejection (dB)	Load Regulation (mV)	Protection Circuit	Package/Part No.			
BD00FC0W	4.0 to 26.5	Variable	±1	1.0	0.5	0.30 (I _o =500mA)	55	Vo × 0.01 (I _o =5mA to 1A)	Over-Current/Temperature	TO252-5	HTSOP-J8		
BD30FC0W		3								BD00FC0WFP	BD00FC0WEFJ		
BD33FC0W		3.3								BD30FC0WFP	BD30FC0WEFJ		
BD50FC0W		5								BD33FC0WFP	BD33FC0WEFJ		
BD60FC0W		6								BD50FC0WFP	BD50FC0WEFJ		
BD70FC0W		7								BD60FC0WFP	BD60FC0WEFJ		
BD80FC0W		8								BD70FC0WFP	BD70FC0WEFJ		
BD90FC0W		9								BD80FC0WFP	BD80FC0WEFJ		
BDJ0FC0W		10								BD90FC0WFP	BD90FC0WEFJ		
BDJ2FC0W		12								BDJ0FC0WFP	BDJ0FC0WEFJ		
BDJ5FC0W	15	BDJ2FC0WFP	BDJ2FC0WEFJ										
BDJ5FC0W	15	BDJ5FC0WFP	BDJ5FC0WEFJ										
Type	Input Voltage (V)	Output Voltage (V)	Output Voltage Precision(%)	Output Current (A)	Bias Current (mA)	I/O Voltage Difference (V)	Ripple Rejection (dB)	Load Regulation (mV)	Protection Circuit	Package/Part No.			
BA00CC0W	4 to 25	Variable 3.0 to 15.0	±2.0	1.0	2.5	0.30 (I _o =0.5A)	55	50 (I _o =5mA to 1A)	Over-Voltage/Over-Current/Temperature	TO220FP-5	TO252-5		
BA03CC0W		3.0								BA00CC0WT	BA00CC0WFP		
BA033CC0W		3.3								BA00CC0WCP-V5 (TO220CP-V5)	—		
BA05CC0W		5.0								BA03CC0WT	—		
BA06CC0W		6.0								BA033CC0WT	BA033CC0WFP		
BA07CC0W		7.0								BA05CC0WT	BA05CC0WFP		
BA08CC0W		8.0								—	BA06CC0WFP		
BA09CC0W		9.0								BA07CC0WT	BA07CC0WFP		
BAJ0CC0W		10.0								BA08CC0WT	BA08CC0WFP		
BAJ2CC0W		12.0								BA09CC0WT	BA09CC0WFP		
BAJ2CC0W	12.0	BAJ0CC0WT	—										
BAJ2CC0W	12.0	BAJ2CC0WT	BAJ2CC0WFP										
Type	Input Voltage (V)	Output Voltage (V)	Output Voltage Precision(%)	Output Current (A)	Bias Current (mA)	I/O Voltage Difference (V)	Ripple Rejection (dB)	Load Regulation (mV)	Protection Circuit	Package/Part No.			
BD00C0AW	4.0 to 26.5	Variable 3.0 to 15.0	±1.0	1.0	0.5	0.30 (I _o =500mA)	55	Vo × 0.01 (I _o =5mA to 1A)	Over-Current/Temperature	TO252-5	TO220CP-V5		
BD33C0AW	4.3 to 26.5	3.3								BD00C0AWFP	BD00C0AWCP-V5		
BD50C0AW	6.0 to 26.5	5.0								BD33C0AWFP	—		
BD50C0AW	6.0 to 26.5	5.0	BD50C0AWFP	—									

35V Voltage Resistance 1A LDO Regulators : * Vo is Output voltage/Unit : V
 35V Voltage Resistance 1A LDO Regulators (Automotive grade) : * Vo is Output voltage/Unit : V

Single-Output LDO Regulators

Please ensure that minimum input voltage always exceeds the sum of output voltage and drop out voltage for the device.

35V Resistance 1A LDO Regulators with Shutdown Switch

Part No.	Input Voltage (V)	Output Voltage (V)	Output Voltage Precision (%)	Output Current (A)	Saturation Voltage (V)	Circuit Current (mA)	Operating Temperature (°C)	Protection Circuit	Package	Automotive Grade AEC-Q100		
BD00C0AWFPS-M	4.0 to 26.5	Variable 3.0 to 15.0	±3.0 (T _{as} = -40 to +105°C)	1.0	0.3 (I _o = 500mA)	0.5	-40 to +105	Over-Current/Temperature	TO252S-5	YES		
Type	Input Voltage (V)	Output Voltage (V)	Output Voltage Precision (%)	Output Current (A)	Bias Current (mA)	I/O Voltage Difference (V)	Ripple Rejection (dB)	Load Regulation (V)	Protection Circuit	Package/Part No.		Automotive Grade AEC-Q100
BD00C0AW	4.0 to 26.5	Variable 1.0 to 15.0	±3.0 (T _{as} = -40 to +125°C)	1.0	0.5	0.3 (I _o = 500mA)	55	* V _o × 0.01 (I _o = 5mA to 1A)	Over-Current/Temperature	TO252-5		YES
BD33C0AW	4.3 to 26.5	3.3								HRP5		
BD50C0AW	6.0 to 26.5	5.0								TO263-5		
BD80C0AW	9.0 to 26.5	8.0								BD00C0AWFP-C		
BD90C0AW	10.0 to 26.5	9.0								BD00C0AWHFP-C		
									BD00C0AWFP2-C	BD00C0AWHFP2-C	BD00C0AWFP2-C	YES
									BD33C0AWFP-C	BD33C0AWHFP-C	BD33C0AWFP2-C	YES
									BD50C0AWFP-C	BD50C0AWHFP-C	BD50C0AWFP2-C	YES
									BD80C0AWFP-C	BD80C0AWHFP-C	BD80C0AWFP2-C	YES
									BD90C0AWFP-C	BD90C0AWHFP-C	BD90C0AWFP2-C	YES

35V Resistance 300mA LDO Regulator with Shutdown Switch

Part No.	Input Voltage (V)	Output Voltage (V)	Output Voltage Precision (%)	Output Current (A)	Bias Current (mA)	I/O Voltage Difference (V)	Ripple Rejection (dB)	Load Regulation	Protection Circuit	Package
BA3662CP-V5	4 to 25	Variable 3.0 to 15.0	±2.0	0.3	2.5	0.3 (I _o = 0.2A)	55	40mV (I _o = 5mA to 200mA)	Over-Voltage/Over-Current/Temperature	TO220CP-V5

30V Resistance 100mA LDO Regulators

Part No.	Input Voltage (V)	Output Voltage (V)	Output Voltage Precision (%)	Output Current (A)	Bias Current (mA)	I/O Voltage Difference (V)	Load Regulation (%)	Protection Circuit	Input Capacitor (μF)	Output Capacitor (μF)	Package
BD33FA1FP3	V _o + 3 to 25	3.3	±1	0.1	0.3	1 (I _o = 100mA)	±1.5	Over-Current/Temperature	1	1	SOT89-3
BD50FA1FP3		5.0									
BD54FA1FP3		5.4									
BDJ2FA1FP3		12.0									

30V Resistance 100mA LDO Regulators with Shutdown Switch

Part No.	Input Voltage (V)	Output Voltage (V)	Output Voltage Precision (%)	Output Current (A)	Bias Current (mA)	I/O Voltage Difference (V)	Load Regulation (%)	Protection Circuit	Input Capacitor (μF)	Output Capacitor (μF)	Package	Automotive Grade AEC-Q100
BD50FA1MG-M	V _o + 3 to 25	5	±1	0.1	0.5	2 (I _o = 100mA)	±1.5	Over-Current/Temperature	1	1	SSOP5	YES
BD00FA1WEFJ	V _o + 3 to 25	Variable (3.0 to 12.0)	±1	0.1	0.3	2 (I _o = 100mA)	±1.5	Over-Current/Temperature	2.2	2.2	HTSOP-J8	

18V Resistance 1.5A LDO Regulators

Part No.	Input Voltage (V)	Output Voltage (V)	Output Voltage Precision (%)	Output Current (A)	Bias Current (mA)	I/O Voltage Difference (V)	Ripple Rejection (dB)	Load Regulation (mV)	Input Capacitor (μF)	Output Capacitor (μF)	Protection Circuit	Package
BA15JC5T	3 to 16	1.5	±1.0	1.5	0.5	0.3 (I _o = 500mA)	55	5 (I _o = 5mA to 1.5A)	0.33	22	Over-Current/Temperature	TO220FP-3
BA18JC5T		1.8										TO220FP-3
BA25JC5T		2.5										TO220FP-3
BA30JC5T		3.0										TO220FP-3
BA33JC5T		3.3										TO220FP-3
BA50JC5T		5.0										TO220FP-3
BA60JC5T		6.0										TO220FP-3
BA80JC5T		8.0										TO220FP-3
BA90JC5T		9.0										TO220FP-3

18V Resistance 1.5A LDO Regulator with Shutdown Switch

Part No.	Input Voltage (V)	Output Voltage (V)	Output Voltage Precision (%)	Output Current (A)	Bias Current (mA)	I/O Voltage Difference (V)	Ripple Rejection (dB)	Load Regulation (mV)	Input Capacitor (μF)	Output Capacitor (μF)	Shutdown Switch	Protection Circuit	Package
BA00JC5WT	3 to 16	Variable 1.5 to 12.0	±1.0	1.5	0.5	0.3 (I _o = 500mA)	55	5 (I _o = 5mA to 1.5A)	0.33	22	✓	Over-Current/Temperature	TO220FP-5

18V Resistance 1A LDO Regulators

Type	Input Voltage (V)	Output Voltage (V)	Output Voltage Precision (%)	Output Current (A)	Bias Current (mA)	I/O Voltage Difference (V)	Ripple Rejection (dB)	Load Regulation (mV)	Input Capacitor (μF)	Output Capacitor (μF)	Protection Circuit	Package/Part No.	
BA15BC0	3 to 16	1.5	±2.0	1.0	0.5	0.3 (I _o = 200mA)	55	35 (I _o = 0 to 1A)	0.33	22	Over-Current/Temperature	TO252-3	TO220FP-3
BA18BC0		1.8										BA15BC0FP	BA15BC0T
BA25BC0		2.5										BA18BC0FP	BA18BC0T
BA30BC0		3.0										BA25BC0FP	BA25BC0T
BA33BC0		3.3										BA30BC0FP	BA30BC0T
BA50BC0		5.0			BA33BC0FP							BA33BC0T	
BA60BC0		6.0			BA50BC0FP							BA50BC0T	
BA70BC0		7.0			BA60BC0FP							BA60BC0T	
BA80BC0		8.0			BA70BC0FP							BA70BC0T	
BA90BC0		9.0			BA80BC0FP							BA80BC0T	
BAJ0BC0		10.0			BA90BC0FP							BA90BC0T	
					0.6						BAJ0BC0FP	BAJ0BC0T	

 35V Voltage Resistance 1A LDO Regulators with Shutdown Switch (Automotive grade) : * V_o is Output Voltage/Unit : V

A Power Management

Please ensure that minimum input voltage always exceeds the sum of output voltage and drop out voltage for the device.

18V Resistance 1A LDO Regulators with Shutdown Switch														
Type	Input Voltage (V)	Output Voltage (V)	Output Voltage Precision (%)	Output Current (A)	Bias Current (mA)	I/O Voltage Difference (V)	Ripple Rejection (dB)	Load Regulation (mV)	Input Capacitor (μF)	Output Capacitor (μF)	Shutdown Switch	Protection Circuit	Package/Part No.	
													TO252-5	TO220FP-5
BA00BC0W	3 to 16	Variable 1.5 to 12.0	±2.0	1.0	0.5 (Vo≦6.0)	0.3 (Io=200mA)	55	35 (Io=0 to 1A)	0.33	22	✓	Over-Current/ Temperature	BA00BC0WFP BA00BC0WCP-V5 (TO220CP-V5)	BA00BC0WT
BA15BC0W		1.5			BA15BC0WFP								BA15BC0WT	
BA18BC0W		1.8			BA18BC0WFP								BA18BC0WT	
BA25BC0W		2.5			BA25BC0WFP								BA25BC0WT	
BA30BC0W		3.0			BA30BC0WFP								BA30BC0WT	
BA33BC0W		3.3			BA33BC0WFP								BA33BC0WT	
BA50BC0W		5.0			BA50BC0WFP								BA50BC0WT	
BA60BC0W		6.0			BA60BC0WFP								BA60BC0WT	
BA70BC0W		7.0			BA70BC0WFP								BA70BC0WT	
BA80BC0W		8.0			BA80BC0WFP								BA80BC0WT	
BA90BC0W		9.0			BA90BC0WFP								BA90BC0WT	
BAJ0BC0W		10.0			BAJ0BC0WFP								BAJ0BC0WT	

15V Resistance 1A LDO Regulators with Shutdown Switch															
Part No.		Input Voltage (V)	Output Voltage (V)	Output Voltage Precision (%)	Output Current (A)	Bias Current (mA)	I/O Voltage Difference (V)	Ripple Rejection (dB)	Load Regulation (mV)	Input Capacitor (μF)	Output Capacitor (μF)	Shutdown Switch	Protection Circuit	Package	Automotive Grade AEC-Q100
Consumer / Automotive Grade															
BD00GC0WEFJ / BD00GC0MEFJ-M		4.5 to 14.0	Variable 1.5 to 13.0	±1.0 (Ta=25°C) / ±3.0 (Ta=-40 to +105°C) <Automotive Grade>	1.0	0.6	0.6 (Io=1A)	60 (f=100Hz, 50mVpp, Io=0A)	25 (Io=0 to 1A)	1.0	1.0	✓	Over-Current/ Temperature	HTSOP-J8	— / YES
BD15GC0WEFJ / BD15GC0MEFJ-M			1.5											HTSOP-J8	— / YES
BD18GC0WEFJ / BD18GC0MEFJ-M			1.8											HTSOP-J8	— / YES
BD25GC0WEFJ / BD25GC0MEFJ-M			2.5											HTSOP-J8	— / YES
BD30GC0WEFJ / BD30GC0MEFJ-M			3.0											HTSOP-J8	— / YES
BD33GC0WEFJ / BD33GC0MEFJ-M			3.3											HTSOP-J8	— / YES
BD50GC0WEFJ / BD50GC0MEFJ-M			5.0											HTSOP-J8	— / YES
BD60GC0WEFJ / BD60GC0MEFJ-M			6.0											HTSOP-J8	— / YES
BD70GC0WEFJ / BD70GC0MEFJ-M			7.0											HTSOP-J8	— / YES
BD80GC0WEFJ / BD80GC0MEFJ-M			8.0											HTSOP-J8	— / YES
BD90GC0WEFJ / BD90GC0MEFJ-M			9.0											HTSOP-J8	— / YES
BDJ0GC0WEFJ / BDJ0GC0MEFJ-M			10.0											HTSOP-J8	— / YES
BDJ2GC0WEFJ / BDJ2GC0MEFJ-M		12.0	HTSOP-J8	— / YES											

15V Resistance 1A Variable/Fixed Output LDO Regulators(Industrial Equipment)														
Part No.	Input Voltage (V)	Output Voltage (V)	Output Voltage Precision (%)	Output Current (A)	Bias Current (mA)	I/O Voltage Difference (V)	Ripple Rejection (dB)	Load Regulation (mV)	Input Capacitor (μF)	Output Capacitor (μF)	Shutdown Switch	Protection Circuit	Package	
BD00GC0MEFJ-LB	4.5 to 14.0	Variable 1.5 to 13.0	±1.0 / ±3.0 (Ta=-40 to +105°C)	1.0	0.6	0.6 (Io=1A)	60 (f=100Hz, 50mVpp, Io=0A)	25 (Io=0 to 1A)	1.0	1.0	✓	Over-Current/ Temperature	HTSOP-J8	
BD15GC0MEFJ-LB		1.5											HTSOP-J8	
BD18GC0MEFJ-LB		1.8											HTSOP-J8	
BD25GC0MEFJ-LB		2.5											HTSOP-J8	
BD30GC0MEFJ-LB		3.0											HTSOP-J8	
BD33GC0MEFJ-LB		3.3											HTSOP-J8	
BD50GC0MEFJ-LB		5.0											HTSOP-J8	
BD60GC0MEFJ-LB		6.0											HTSOP-J8	
BD70GC0MEFJ-LB		7.0											HTSOP-J8	
BD80GC0MEFJ-LB		8.0											HTSOP-J8	
BD90GC0MEFJ-LB		9.0											HTSOP-J8	
BDJ0GC0MEFJ-LB		10.0											HTSOP-J8	
BDJ2GC0MEFJ-LB	12.0	HTSOP-J8												

Single-Output LDO Regulators

Please ensure that minimum input voltage always exceeds the sum of output voltage and drop out voltage for the device.

15V Voltage Resistance 500mA LDO Regulators with Shutdown Switch

Part No.	Input Voltage (V)	Output Voltage (V)	Output Voltage Precision (%)	Output Current (A)	Bias Current (mA)	I/O Voltage Difference (V)	Ripple Rejection (dB)	Load Regulation (mV)	Input Capacitor (μF)	Output Capacitor (μF)	Shutdown Switch	Protection Circuit	Package	Automotive Grade AEC-Q100
Consumer / Automotive Grade														
BD00GA5WEFJ / BD00GA5MEFJ-M	4.5 to 14.0	Variable 1.5 to 13.0	±1.0 (Ta=25°C) / ±3.0 (Ta=-40 to +105°C) <Automotive Grade>	0.5	0.6	0.6 (Io=500mA)	60 (f=100Hz, 50mVpp, Io=0A)	25 (Io=0 to 500mA)	1.0	1.0	✓	Over-Current/ Temperature	HTSOP-J8	— / YES
BD15GA5WEFJ / BD15GA5MEFJ-M		1.5											HTSOP-J8	— / YES
BD18GA5WEFJ / BD18GA5MEFJ-M		1.8											HTSOP-J8	— / YES
BD25GA5WEFJ / BD25GA5MEFJ-M		2.5											HTSOP-J8	— / YES
BD30GA5WEFJ / BD30GA5MEFJ-M		3.0											HTSOP-J8	— / YES
BD33GA5WEFJ / BD33GA5MEFJ-M		3.3											HTSOP-J8	— / YES
BD50GA5WEFJ / BD50GA5MEFJ-M		5.0											HTSOP-J8	— / YES
BD60GA5WEFJ / BD60GA5MEFJ-M		6.0											HTSOP-J8	— / YES
BD70GA5WEFJ / BD70GA5MEFJ-M		7.0											HTSOP-J8	— / YES
BD80GA5WEFJ / BD80GA5MEFJ-M		8.0											HTSOP-J8	— / YES
BD90GA5WEFJ / BD90GA5MEFJ-M		9.0											HTSOP-J8	— / YES
BDJ0GA5WEFJ / BDJ0GA5MEFJ-M		10.0											HTSOP-J8	— / YES
BDJ2GA5WEFJ / BDJ2GA5MEFJ-M		12.0											HTSOP-J8	— / YES

15V Resistance 500mA Variable/Fixed Output LDO Regulators(Industrial Equipment)

Part No.	Input Voltage (V)	Output Voltage (V)	Output Voltage Precision (%)	Output Current (A)	Bias Current (mA)	I/O Voltage Difference (V)	Ripple Rejection (dB)	Load Regulation (mV)	Input Capacitor (μF)	Output Capacitor (μF)	Shutdown Switch	Protection Circuit	Package	
Consumer / Automotive Grade														
BD00GA5MEFJ-LB	4.5 to 14.0	Variable 1.5 to 13.0	±1.0 / ±3.0 (Ta=-40 to +105°C)	0.5	0.6	0.6 (Io=500mA)	60 (f=100Hz, 50mVpp, Io=0A)	25 (Io=0 to 500mA)	1.0	1.0	✓	Over-Current/ Temperature	HTSOP-J8	
BD15GA5MEFJ-LB		1.5											HTSOP-J8	
BD18GA5MEFJ-LB		1.8											HTSOP-J8	
BD25GA5MEFJ-LB		2.5											HTSOP-J8	
BD30GA5MEFJ-LB		3.0											HTSOP-J8	
BD33GA5MEFJ-LB		3.3											HTSOP-J8	
BD50GA5MEFJ-LB		5.0											HTSOP-J8	
BD60GA5MEFJ-LB		6.0											HTSOP-J8	
BD70GA5MEFJ-LB		7.0											HTSOP-J8	
BD80GA5MEFJ-LB		8.0											HTSOP-J8	
BD90GA5MEFJ-LB		9.0											HTSOP-J8	
BDJ0GA5MEFJ-LB		10.0											HTSOP-J8	
BDJ2GA5MEFJ-LB		12.0											HTSOP-J8	

15V Resistance 300mA LDO Regulators with Shutdown Switch

Type	Input Voltage (V)	Output Voltage (V)	Output Voltage Precision (%)	Output Current (A)	Bias Current (mA)	I/O Voltage Difference (V)	Ripple Rejection (dB)	Load Regulation (mV)	Input Capacitor (μF)	Output Capacitor (μF)	Shutdown Switch	Protection Circuit	Package/Part No.	
													HTSOP-J8	VSON008X2030
BD00GA3W	4.5 to 14.0	Variable 1.5 to 13.0	±1.0	0.3	0.6	0.6 (Io=300mA)	60 (f=100Hz, 50mVpp, Io=0A)	25 (Io=0 to 300mA)	1.0	1.0	✓	Over-Current/ Temperature	BD00GA3WEFJ	BD00GA3WNNUX
BD15GA3W		1.5											BD15GA3WEFJ	☆BD15GA3WNNUX
BD18GA3W		1.8											BD18GA3WEFJ	☆BD18GA3WNNUX
BD25GA3W		2.5											BD25GA3WEFJ	☆BD25GA3WNNUX
BD30GA3W		3.0											BD30GA3WEFJ	☆BD30GA3WNNUX
BD33GA3W		3.3											BD33GA3WEFJ	☆BD33GA3WNNUX
BD50GA3W		5.0											BD50GA3WEFJ	BD50GA3WNNUX
BD60GA3W		6.0											BD60GA3WEFJ	BD60GA3WNNUX
BD70GA3W		7.0											BD70GA3WEFJ	☆BD70GA3WNNUX
BD80GA3W		8.0											BD80GA3WEFJ	☆BD80GA3WNNUX
BD90GA3W		9.0											BD90GA3WEFJ	☆BD90GA3WNNUX
BDJ0GA3W		10.0											BDJ0GA3WEFJ	☆BDJ0GA3WNNUX
BDJ2GA3W		12.0											BDJ2GA3WEFJ	☆BDJ2GA3WNNUX

☆ : Under Development

Please ensure that minimum input voltage always exceeds the sum of output voltage and drop out voltage for the device.

15V Resistance 300mA LDO Regulators with Shutdown Switch														
Part No.	Input Voltage (V)	Output Voltage (V)	Output Voltage Precision (%)	Output Current (A)	Bias Current (mA)	I/O Voltage Difference (V)	Ripple Rejection (dB)	Load Regulation (mV)	Input Capacitor (μF)	Output Capacitor (μF)	Shutdown Switch	Protection Circuit	Package	Automotive Grade AEC-Q100
BD00GA3MEFJ-M	4.5 to 14.0	Variable 1.5 to 13.0	±3.0 (Ta=-40 to +105°C) <Automotive Grade>	0.3	0.6	0.6 (Io=300mA)	60 (f=100Hz, 50mVpp, Io=0A)	25 (Io=0 to 300mA)	1.0	1.0	✓	Over-Current/ Temperature	HTSOP-J8	YES
BD15GA3MEFJ-M		1.5											HTSOP-J8	YES
BD18GA3MEFJ-M		1.8											HTSOP-J8	YES
BD25GA3MEFJ-M		2.5											HTSOP-J8	YES
BD30GA3MEFJ-M		3.0											HTSOP-J8	YES
BD33GA3MEFJ-M		3.3											HTSOP-J8	YES
BD50GA3MEFJ-M		5.0											HTSOP-J8	YES
BD60GA3MEFJ-M		6.0											HTSOP-J8	YES
BD70GA3MEFJ-M		7.0											HTSOP-J8	YES
BD80GA3MEFJ-M		8.0											HTSOP-J8	YES
BD90GA3MEFJ-M		9.0											HTSOP-J8	YES
BDJ0GA3MEFJ-M		10.0											HTSOP-J8	YES
BDJ2GA3MEFJ-M	12.0	HTSOP-J8	YES											

15V Resistance 300mA Variable/Fixed Output LDO Regulators(Industrial Equipment)														
Part No.	Input Voltage (V)	Output Voltage (V)	Output Voltage Precision (%)	Output Current (A)	Bias Current (mA)	I/O Voltage Difference (V)	Ripple Rejection (dB)	Load Regulation (mV)	Input Capacitor (μF)	Output Capacitor (μF)	Shutdown Switch	Protection Circuit	Package	Automotive Grade AEC-Q100
BD00GA3MEFJ-LB	4.5 to 14.0	Variable 1.5 to 13.0	±3.0 (Ta=-40 to +105°C)	0.3	0.6	0.6 (Io=300mA)	60 (f=100Hz, 50mVpp, Io=0A)	25 (Io=0 to 300mA)	1.0	1.0	✓	Over-Current/ Temperature	HTSOP-J8	
BD15GA3MEFJ-LB		1.5											HTSOP-J8	
BD18GA3MEFJ-LB		1.8											HTSOP-J8	
BD25GA3MEFJ-LB		2.5											HTSOP-J8	
BD30GA3MEFJ-LB		3.0											HTSOP-J8	
BD33GA3MEFJ-LB		3.3											HTSOP-J8	
BD50GA3MEFJ-LB		5.0											HTSOP-J8	
BD60GA3MEFJ-LB		6.0											HTSOP-J8	
BD70GA3MEFJ-LB		7.0											HTSOP-J8	
BD80GA3MEFJ-LB		8.0											HTSOP-J8	
BD90GA3MEFJ-LB		9.0											HTSOP-J8	
BDJ0GA3MEFJ-LB		10.0											HTSOP-J8	
BDJ2GA3MEFJ-LB	12.0	HTSOP-J8												

10V Resistance 1.5A LDO Regulators with Shutdown Switch														
Part No.	Input Voltage (V)	Output Voltage (V)	Output Voltage Precision (%)	Output Current (A)	Bias Current (mA)	I/O Voltage Difference (V)	Ripple Rejection (dB)	Load Regulation (mV)	Input Capacitor (μF)	Output Capacitor (μF)	Shutdown Switch	Protection Circuit	Package	Automotive Grade AEC-Q100
Consumer / Automotive Grade														
BD00HC5WEFJ / BD00HC5MEFJ-M	4.5 to 8.0	Variable 1.5 to 7.0	±1.0 (Ta=25°C) / ±3.0 (Ta=-40 to +105°C) <Automotive Grade>	1.5	0.6	0.6 (Io=1.5A)	60 (f=100Hz, 50mVpp, Io=0A)	25 (Io=0 to 1.5A)	1.0	1.0	✓	Over-Current/ Temperature	HTSOP-J8	— / YES
BD15HC5WEFJ / BD15HC5MEFJ-M		1.5											HTSOP-J8	— / YES
BD18HC5WEFJ / BD18HC5MEFJ-M		1.8											HTSOP-J8	— / YES
BD25HC5WEFJ / BD25HC5MEFJ-M		2.5											HTSOP-J8	— / YES
BD30HC5WEFJ / BD30HC5MEFJ-M		3.0											HTSOP-J8	— / YES
BD33HC5WEFJ / BD33HC5MEFJ-M		3.3											HTSOP-J8	— / YES
BD50HC5WEFJ / BD50HC5MEFJ-M		5.0											HTSOP-J8	— / YES
BD60HC5WEFJ / BD60HC5MEFJ-M		6.0											HTSOP-J8	— / YES
BD70HC5WEFJ / BD70HC5MEFJ-M		7.0											HTSOP-J8	— / YES

10V Resistance 1.5A Variable/Fixed Output LDO Regulators(Industrial Equipment)														
Part No.	Input Voltage (V)	Output Voltage (V)	Output Voltage Precision (%)	Output Current (A)	Bias Current (mA)	I/O Voltage Difference (V)	Ripple Rejection (dB)	Load Regulation (mV)	Input Capacitor (μF)	Output Capacitor (μF)	Shutdown Switch	Protection Circuit	Package	Automotive Grade AEC-Q100
BD00HC5MEFJ-LB	4.5 to 8.0	Variable 1.5 to 7.0	±1.0 / ±3.0 (Ta=-40 to +105°C)	1.5	0.6	0.6 (Io=1.5A)	60 (f=100Hz, 50mVpp, Io=0A)	25 (Io=0 to 1.5A)	1.0	1.0	✓	Over-Current/ Temperature	HTSOP-J8	
BD15HC5MEFJ-LB		1.5											HTSOP-J8	
BD18HC5MEFJ-LB		1.8											HTSOP-J8	
BD25HC5MEFJ-LB		2.5											HTSOP-J8	
BD30HC5MEFJ-LB		3.0											HTSOP-J8	
BD33HC5MEFJ-LB		3.3											HTSOP-J8	
BD50HC5MEFJ-LB		5.0											HTSOP-J8	
BD60HC5MEFJ-LB		6.0											HTSOP-J8	
BD70HC5MEFJ-LB		7.0											HTSOP-J8	

Single-Output LDO Regulators

Please ensure that minimum input voltage always exceeds the sum of output voltage and drop out voltage for the device.

10V Resistance 1A LDO Regulators with Shutdown Switch

Part No. Consumer / Automotive Grade	Input Voltage (V)	Output Voltage (V)	Output Voltage Precision (%)	Output Current (A)	Bias Current (mA)	I/O Voltage Difference (V)	Ripple Rejection (dB)	Load Regulation (mV)	Input Capacitor (μF)	Output Capacitor (μF)	Shutdown Switch	Protection Circuit	Package	Automotive Grade AEC-Q100
BD00HC0WEFJ / BD00HC0MEFJ-M	4.5 to 8.0	Variable 0.8 to 7.0 (Automotive grade Variable 1.5 to 7.0)	±1.0 (Ta=25°C) / ±3.0 (Ta=-40 to +105°C) <Automotive Grade>	1.0	0.6	0.6 (Io=1A)	60 (f=100Hz, 50mVpp, Io=0A)	25 (Io=0 to 1A)	1.0	1.0	✓	Over-Current/ Temperature	HTSOP-J8	— / YES
BD15HC0WEFJ / BD15HC0MEFJ-M		1.5											HTSOP-J8	— / YES
BD18HC0WEFJ / BD18HC0MEFJ-M		1.8											HTSOP-J8	— / YES
BD25HC0WEFJ / BD25HC0MEFJ-M		2.5											HTSOP-J8	— / YES
BD30HC0WEFJ / BD30HC0MEFJ-M		3.0											HTSOP-J8	— / YES
BD33HC0WEFJ / BD33HC0MEFJ-M		3.3											HTSOP-J8	— / YES
BD50HC0WEFJ / BD50HC0MEFJ-M		5.0											HTSOP-J8	— / YES
BD60HC0WEFJ / BD60HC0MEFJ-M		6.0											HTSOP-J8	— / YES
BD70HC0WEFJ / BD70HC0MEFJ-M		7.0											HTSOP-J8	— / YES

10V Resistance 1A Variable/Fixed Output LDO Regulators(Industrial Equipment)

Part No.	Input Voltage (V)	Output Voltage (V)	Output Voltage Precision (%)	Output Current (A)	Bias Current (mA)	I/O Voltage Difference (V)	Ripple Rejection (dB)	Load Regulation (mV)	Input Capacitor (μF)	Output Capacitor (μF)	Shutdown Switch	Protection Circuit	Package
BD00HC0MEFJ-LB	4.5 to 8.0	Variable 0.8 to 7.0 (Variable 1.5 to 7.0)	±1.0 / ±3.0 (Ta=-40 to +105°C)	1.0	0.6	0.6 (Io=1A)	60 (f=100Hz, 50mVpp, Io=0A)	25 (Io=0 to 1A)	1.0	1.0	✓	Over-Current/ Temperature	HTSOP-J8
BD15HC0MEFJ-LB		1.5											HTSOP-J8
BD18HC0MEFJ-LB		1.8											HTSOP-J8
BD25HC0MEFJ-LB		2.5											HTSOP-J8
BD30HC0MEFJ-LB		3.0											HTSOP-J8
BD33HC0MEFJ-LB		3.3											HTSOP-J8
BD50HC0MEFJ-LB		5.0											HTSOP-J8
BD60HC0MEFJ-LB		6.0											HTSOP-J8
BD70HC0MEFJ-LB		7.0											HTSOP-J8

10V Resistance 500mA LDO Regulators with Shutdown Switch

Part No. Consumer / Automotive Grade	Input Voltage (V)	Output Voltage (V)	Output Voltage Precision (%)	Output Current (A)	Bias Current (mA)	I/O Voltage Difference (V)	Ripple Rejection (dB)	Load Regulation (mV)	Input Capacitor (μF)	Output Capacitor (μF)	Shutdown Switch	Protection Circuit	Package	Automotive Grade AEC-Q100
BD00HA5WEFJ / BD00HA5MEFJ-M	4.5 to 8.0	Variable 1.5 to 7.0	±1.0 (Ta=25°C) / ±3.0 (Ta=-40 to +105°C) <Automotive Grade>	0.5	0.6	0.6 (Io=500mA)	60 (f=100Hz, 50mVpp, Io=0A)	25 (Io=0 to 500mA)	1.0	1.0	✓	Over-Current/ Temperature	HTSOP-J8	— / YES
BD15HA5WEFJ / BD15HA5MEFJ-M		1.5											HTSOP-J8	— / YES
BD18HA5WEFJ / BD18HA5MEFJ-M		1.8											HTSOP-J8	— / YES
BD25HA5WEFJ / BD25HA5MEFJ-M		2.5											HTSOP-J8	— / YES
BD30HA5WEFJ / BD30HA5MEFJ-M		3.0											HTSOP-J8	— / YES
BD33HA5WEFJ / BD33HA5MEFJ-M		3.3											HTSOP-J8	— / YES
BD50HA5WEFJ / BD50HA5MEFJ-M		5.0											HTSOP-J8	— / YES
BD60HA5WEFJ / BD60HA5MEFJ-M		6.0											HTSOP-J8	— / YES
BD70HA5WEFJ / BD70HA5MEFJ-M		7.0											HTSOP-J8	— / YES

10V Resistance 500mA Variable/Fixed Output LDO Regulators(Industrial Equipment)

Part No.	Input Voltage (V)	Output Voltage (V)	Output Voltage Precision (%)	Output Current (A)	Bias Current (mA)	I/O Voltage Difference (V)	Ripple Rejection (dB)	Load Regulation (mV)	Input Capacitor (μF)	Output Capacitor (μF)	Shutdown Switch	Protection Circuit	Package
BD00HA5MEFJ-LB	4.5 to 8.0	Variable 1.5 to 7.0	±1.0 / ±3.0 (Ta=-40 to +105°C)	0.5	0.6	0.6 (Io=500mA)	60 (f=100Hz, 50mVpp, Io=0A)	25 (Io=0 to 500mA)	1.0	1.0	✓	Over-Current/ Temperature	HTSOP-J8
BD15HA5MEFJ-LB		1.5											HTSOP-J8
BD18HA5MEFJ-LB		1.8											HTSOP-J8
BD25HA5MEFJ-LB		2.5											HTSOP-J8
BD30HA5MEFJ-LB		3.0											HTSOP-J8
BD33HA5MEFJ-LB		3.3											HTSOP-J8
BD50HA5MEFJ-LB		5.0											HTSOP-J8
BD60HA5MEFJ-LB		6.0											HTSOP-J8
BD70HA5MEFJ-LB		7.0											HTSOP-J8

Please ensure that minimum input voltage always exceeds the sum of output voltage and drop out voltage for the device.

10V Resistance 300mA LDO Regulators with Shutdown Switch														
Part No.	Input Voltage (V)	Output Voltage (V)	Output Voltage Precision (%)	Output Current (A)	Bias Current (mA)	I/O Voltage Difference (V)	Ripple Rejection (dB)	Load Regulation (mV)	Input Capacitor (μF)	Output Capacitor (μF)	Shutdown Switch	Protection circuit	Package	Automotive Grade AEC-Q100
Consumer / Automotive Grade														
BD00HA3WEFJ / BD00HA3MEFJ-M	4.5 to 8.0	Variable 1.5 to 7.0	±1.0 (Ta=25°C) / ±3.0 (Ta=-40 to +105°C) <Automotive Grade>	0.3	0.6	0.6 (Ic=300mA)	60 (f=100Hz, 50mVpp, Ic=0A)	25 (Ic=0 to 300mA)	1.0	1.0	✓	Over-Current/ Temperature	HTSOP-J8	— / YES
BD15HA3WEFJ / BD15HA3MEFJ-M		1.5											HTSOP-J8	— / YES
BD18HA3WEFJ / BD18HA3MEFJ-M		1.8											HTSOP-J8	— / YES
BD25HA3WEFJ / BD25HA3MEFJ-M		2.5											HTSOP-J8	— / YES
BD30HA3WEFJ / BD30HA3MEFJ-M		3.0											HTSOP-J8	— / YES
BD33HA3WEFJ / BD33HA3MEFJ-M		3.3											HTSOP-J8	— / YES
BD50HA3WEFJ / BD50HA3MEFJ-M		5.0											HTSOP-J8	— / YES
BD60HA3WEFJ / BD60HA3MEFJ-M		6.0											HTSOP-J8	— / YES
BD70HA3WEFJ / BD70HA3MEFJ-M		7.0											HTSOP-J8	— / YES

10V Resistance 300mA Variable/Fixed Output LDO Regulators(Industrial Equipment)														
Part No.	Input Voltage (V)	Output Voltage (V)	Output Voltage Precision (%)	Output Current (A)	Bias Current (mA)	I/O Voltage Difference (V)	Ripple Rejection (dB)	Load Regulation (mV)	Input Capacitor (μF)	Output Capacitor (μF)	Shutdown Switch	Protection circuit	Package	
BD00HA3MEFJ-LB	4.5 to 8.0	Variable 1.5 to 7.0	±1.0 / ±3.0 (Ta=-40 to +105°C)	0.3	0.6	0.6 (Ic=300mA)	60 (f=100Hz, 50mVpp, Ic=0A)	25 (Ic=0 to 300mA)	1.0	1.0	✓	Over-Current/ Temperature	HTSOP-J8	
BD15HA3MEFJ-LB		1.5											HTSOP-J8	
BD18HA3MEFJ-LB		1.8											HTSOP-J8	
BD25HA3MEFJ-LB		2.5											HTSOP-J8	
BD30HA3MEFJ-LB		3.0											HTSOP-J8	
BD33HA3MEFJ-LB		3.3											HTSOP-J8	
BD50HA3MEFJ-LB		5.0											HTSOP-J8	
BD60HA3MEFJ-LB		6.0											HTSOP-J8	
BD70HA3MEFJ-LB		7.0											HTSOP-J8	

7V Resistance 1A LDO Regulators with Shutdown Switch														
Type	Input Voltage (V)	Output Voltage (V)	Output Voltage Precision (%)	Output Current (A)	Bias Current (mA)	I/O Voltage Difference (V)	Ripple Rejection (dB)	Load Regulation (mV)	Input Capacitor (μF)	Output Capacitor (μF)	Shutdown Switch	Protection circuit	Package/Part No.	
													HTSOP-J8	HVSO6
BD00IC0W	2.4 to 5.5	Variable 0.8 to 4.5	±1.0	1.0	0.3	0.4 (Ic=1A)	60 (f=100Hz, 50mVpp, Ic=0A)	25 (Ic=0 to 1A)	1.0	1.0	✓	Over-Current/ Temperature	BD00IC0WEFJ	BD00IC0WHFV
BD10IC0W		1.0											BD10IC0WEFJ	BD10IC0WHFV
BD12IC0W		1.2											BD12IC0WEFJ	BD12IC0WHFV
BD1CIC0W		1.25											—	BD1CIC0WHFV
BD15IC0W		1.5											BD15IC0WEFJ	BD15IC0WHFV
BD18IC0W		1.8											BD18IC0WEFJ	BD18IC0WHFV
BD25IC0W		2.5											BD25IC0WEFJ	BD25IC0WHFV
BD26IC0W		2.6											—	BD26IC0WHFV
BD30IC0W		3.0											BD30IC0WEFJ	BD30IC0WHFV
BD33IC0W		3.3											BD33IC0WEFJ	BD33IC0WHFV

7V Resistance 1A LDO Regulators with Shutdown Switch														
Part No.	Input Voltage (V)	Output Voltage (V)	Output Voltage Precision (%)	Output Current (A)	Bias Current (mA)	I/O Voltage Difference (V)	Ripple Rejection (dB)	Load Regulation (mV)	Input Capacitor (μF)	Output Capacitor (μF)	Shutdown Switch	Protection circuit	Package	Automotive Grade AEC-Q100
BD00IC0MEFJ-M	2.4 to 5.5	Variable 0.8 to 4.5	±3.0 (Ta=-40 to +105°C)	1.0	0.3	0.4 (Ic=1A)	60 (f=100Hz, 50mVpp, Ic=0A)	25 (Ic=0 to 1A)	1.0	1.0	✓	Over-Current/ Temperature	HTSOP-J8	YES
BD10IC0MEFJ-M		1.0											HTSOP-J8	YES
BD12IC0MEFJ-M		1.2											HTSOP-J8	YES
BD15IC0MEFJ-M		1.5											HTSOP-J8	YES
BD18IC0MEFJ-M		1.8											HTSOP-J8	YES
BD25IC0MEFJ-M		2.5											HTSOP-J8	YES
BD30IC0MEFJ-M		3.0											HTSOP-J8	YES
BD33IC0MEFJ-M		3.3											HTSOP-J8	YES

7V Resistance 1A Variable/Fixed Output LDO Regulators(Industrial Equipment)														
Part No.	Input Voltage (V)	Output Voltage (V)	Output Voltage Precision (%)	Output Current (A)	Bias Current (mA)	I/O Voltage Difference (V)	Ripple Rejection (dB)	Load Regulation (mV)	Input Capacitor (μF)	Output Capacitor (μF)	Shutdown Switch	Protection circuit	Package	
BD00IC0MEFJ-LB	2.4 to 5.5	Variable 0.8 to 4.5	±3.0 (Ta=-40 to +105°C)	1.0	0.3	0.4 (Ic=1A)	60 (f=100Hz, 50mVpp, Ic=0A)	25 (Ic=0 to 1A)	1.0	1.0	✓	Over-Current/ Temperature	HTSOP-J8	
BD10IC0MEFJ-LB		1.0											HTSOP-J8	
BD12IC0MEFJ-LB		1.2											HTSOP-J8	
BD15IC0MEFJ-LB		1.5											HTSOP-J8	
BD18IC0MEFJ-LB		1.8											HTSOP-J8	
BD25IC0MEFJ-LB		2.5											HTSOP-J8	
BD30IC0MEFJ-LB		3.0											HTSOP-J8	
BD33IC0MEFJ-LB		3.3											HTSOP-J8	

A

Power Management

Single-Output LDO Regulators

Please ensure that minimum input voltage always exceeds the sum of output voltage and drop out voltage for the device.

7V Resistance 500mA LDO Regulators

Part No.	Input Voltage (V)	Output Voltage (V)	Output Voltage Precision (%)	Output Current (A)	Bias Current (mA)	I/O Voltage Difference (V)	Ripple Rejection (dB)	Load Regulation (mV)	Input Capacitor (μF)	Output Capacitor (μF)	Protection Circuit	Package
BD10KA5FP	2.3 to 5.5	1.0	±1.0	0.5	0.35	0.12 (I _o =200mA)	50	25 (I _o =0 to 500mA)	1.0	1.0	Over-Current/ Temperature	TO252-3
BD12KA5FP		1.2										TO252-3
BD15KA5FP		1.5										TO252-3
BD18KA5FP		1.8										TO252-3
BD25KA5FP		2.5										TO252-3
BD30KA5FP		3.0										TO252-3
BD33KA5FP		3.3										TO252-3

7V Resistance 500mA LDO Regulators with Shutdown Switch

Type	Input Voltage (V)	Output Voltage (V)	Output Voltage Precision (%)	Output Current (A)	Bias Current (mA)	I/O Voltage Difference (V)	Ripple Rejection (dB)	Load Regulation (mV)	Input Capacitor (μF)	Output Capacitor (μF)	Shutdown Switch	Protection Circuit	Package/Part No.	
													TO252-5	SOP8
BD00KA5W	2.3 to 5.5	Variable 1.0 to 4.0	±1.0	0.5	0.35	0.12 (I _o =200mA)	50	25 (I _o =0 to 500mA)	1.0	1.0	✓	Over-Current/ Temperature	BD00KA5WFP	BD00KA5WF
BD10KA5W		1.0											BD10KA5WFP	BD10KA5WF
BD12KA5W		1.2											BD12KA5WFP	BD12KA5WF
BD15KA5W		1.5											BD15KA5WFP	BD15KA5WF
BD18KA5W		1.8											BD18KA5WFP	BD18KA5WF
BD25KA5W		2.5											BD25KA5WFP	BD25KA5WF
BD30KA5W		3.0											BD30KA5WFP	BD30KA5WF
BD33KA5W		3.3											BD33KA5WFP	BD33KA5WF

Part No.		Input Voltage (V)	Output Voltage (V)	Output Voltage Precision (%)	Output Current (A)	Bias Current (mA)	I/O Voltage Difference (V)	Ripple Rejection (dB)	Load Regulation (mV)	Input Capacitor (μF)	Output Capacitor (μF)	Shutdown Switch	Protection Circuit	Package	Automotive Grade AEC-Q100
Consumer / Automotive Grade															
BD00IA5WEFJ / BD00IA5MEFJ-M		2.4 to 5.5	Variable 0.8 to 4.5	±1.0 (T _a =25°C) / ±3.0 (T _a =-40 to +105°C) <Automotive Grade>	0.5	0.25	0.4 (I _o =500mA)	60 (f=100Hz, 50mVpp, I _o =0A)	25 (I _o =0 to 500mA)	1.0	1.0	✓	Over-Current/ Temperature	HTSOP-J8	— / YES
BD10IA5WEFJ / BD10IA5MEFJ-M			1.0											HTSOP-J8	— / YES
BD12IA5WEFJ / BD12IA5MEFJ-M			1.2											HTSOP-J8	— / YES
BD15IA5WEFJ / BD15IA5MEFJ-M			1.5											HTSOP-J8	— / YES
BD18IA5WEFJ / BD18IA5MEFJ-M			1.8											HTSOP-J8	— / YES
BD25IA5WEFJ / BD25IA5MEFJ-M			2.5											HTSOP-J8	— / YES
BD30IA5WEFJ / BD30IA5MEFJ-M			3.0											HTSOP-J8	— / YES
BD33IA5WEFJ / BD33IA5MEFJ-M			3.3											HTSOP-J8	— / YES

7V Resistance 500mA Variable/Fixed Output LDO Regulators(Industrial Equipment)

Part No.	Input Voltage (V)	Output Voltage (V)	Output Voltage Precision (%)	Output Current (A)	Bias Current (mA)	I/O Voltage Difference (V)	Ripple Rejection (dB)	Load Regulation (mV)	Input Capacitor (μF)	Output Capacitor (μF)	Shutdown Switch	Protection Circuit	Package
BD00IA5MEFJ-LB	2.4 to 5.5	Variable 0.8 to 4.5	±1.0 / ±3.0 (T _a =-40 to +105°C)	0.5	0.25	0.4 (I _o =500mA)	60 (f=100Hz, 50mVpp, I _o =0A)	25 (I _o =0 to 500mA)	1.0	1.0	✓	Over-Current/ Temperature	HTSOP-J8
BD10IA5MEFJ-LB		1.0											HTSOP-J8
BD12IA5MEFJ-LB		1.2											HTSOP-J8
BD15IA5MEFJ-LB		1.5											HTSOP-J8
BD18IA5MEFJ-LB		1.8											HTSOP-J8
BD25IA5MEFJ-LB		2.5											HTSOP-J8
BD30IA5MEFJ-LB		3.0											HTSOP-J8
BD33IA5MEFJ-LB		3.3											HTSOP-J8

6.5V Resistance 500mA Full CMOS LDO Regulators

Part No.	Input Voltage (V)	Output Voltage (V)	Output Voltage Precision (%)	Output Current (A)	Bias Current (μA)	I/O Voltage Difference (mV)	Ripple Rejection (dB)	Load Regulation (mV)	Protection Circuit	Package
New BU18SD5WG	1.7 to 6.0	1.8	±1	0.5	33.0	150 (I _o =100mA)	68	0.5	Over Current/ Temperature	SSOP5
New BU33SD5WG		3.3								

6.5V Resistance 500mA Full CMOS LDO Regulators with Shutdown Switch WL-CSP type

Part No.	Input Voltage (V)	Output Voltage (V)	Output Voltage Precision (%)	Output Current (A)	Bias Current (μA)	I/O Voltage Difference (mV)	Ripple Rejection (dB)	Load Regulation (mV)	Protection Circuit	Package
BU30SA5GWZ	1.8 to 5.0	3	±1	0.5	0.033	0.08 (I _o =100mA)	70dB (f=1kHz)	6 (I _o out=0.01mA to 300mA)	Over Current/ Temperature	UCSP30L1
BU33SA5GWZ		3.3								

Please ensure that minimum input voltage always exceeds the sum of output voltage and drop out voltage for the device.

6.5V Resistance 300mA CMOS LDO Regulators with Shutdown Switch																	
Part No.	Input Voltage (V)	Output Voltage (V)	Output Voltage Precision (%)	Output Current (A)	Vsat (mV)	Ripple Rejection (dB)	Load Regulation (mV)	Circuit Current (μ A)	Output Short Current (mA)	Input Capacitor (μ F)	Output Capacitor (μ F)	Shutdown Switch	Over Current Protection	Temperature Protection	Discharge Function	Soft Start Function	Package
BH15M0AWHFV	2.5 to 5.5	1.5	± 25 mV	0.3	—	60	6 ($I_o=1$ to 100mA)	65	100	1.0	1.0	✓	✓	✓	—	—	HVSOF6
BH18M0AWHFV		1.8															HVSOF6
BH20M0AWHFV		2.0															HVSOF6
BH21M0AWHFV		2.1															HVSOF6
BH25M0AWHFV		2.5	± 1		60 ($I_o=$ 100mA)												HVSOF6
BH26M0AWHFV		2.6															HVSOF6
BH27M0AWHFV		2.7															HVSOF6
BH28M0AWHFV		2.8															HVSOF6
BH29M0AWHFV		2.9															HVSOF6
BH30M0AWHFV		3.0															HVSOF6
BH31M0AWHFV		3.1															HVSOF6
BH32M0AWHFV		3.2															HVSOF6
BH33M0AWHFV		3.3															HVSOF6
BH34M0AWHFV		3.4															HVSOF6

Single-Output LDO Regulators

Please ensure that minimum input voltage always exceeds the sum of output voltage and drop out voltage for the device.

6.5V Resistance 200mA CMOS LDO Regulators with Shutdown Switch

Type	Input Voltage (V)	Output Voltage (V)	Output Voltage Precision (%)	Output Current (A)	Vs _{sat} (mV)	Ripple Rejection (dB)	Load Regulation (mV)	Circuit Current (μA)	Output short Current (mA)	Input Capacitor (μF)	Output Capacitor (μF)	Shutdown Switch	Over Current Protection	Temperature Protection	Discharge Function	Package/Part No.	
																SSON004X1010	SSOP5
BUxxTD2WNVX series BUxxTD3WG series	1.7 to 5.5	1.0	±25mV	0.2	—	70	10 (I _o =1 to 100mA)	35	70	0.47	0.47	✓	✓	✓	✓	BU10TD2WNVX	BU10TD3WG
		1.05														☆BU1ATD2WNVX	—
		1.1														—	BU11TD3WG
		1.15														BU1BD2WNVX	—
		1.2														BU12TD2WNVX	BU12TD3WG
		1.25														BU1CTD2WNVX	BU1CTD3WG
		1.3														—	BU13TD3WG
		1.5														BU15TD2WNVX	BU15TD3WG
		1.8														BU18TD2WNVX	BU18TD3WG
		1.85														BU1JTD2WNVX	BU1JTD3WG
		1.9	BU19TD2WNVX	BU19TD3WG													
		2.0	BU20TD2WNVX	BU20TD3WG													
		2.05	BU2ATD2WNVX	—													
		2.1	BU21TD2WNVX	BU21TD3WG													
		2.3	BU23TD2WNVX	—													
		2.5	BU25TD2WNVX	BU25TD3WG													
		2.6	BU26TD2WNVX	BU26TD3WG													
		2.7	BU27TD2WNVX	BU27TD3WG													
		2.75	BU2HTD2WNVX	—													
		2.8	BU28TD2WNVX	BU28TD3WG													
2.85	BU2JTD2WNVX	BU2JTD3WG															
2.9	BU29TD2WNVX	BU29TD3WG															
3.0	BU30TD2WNVX	BU30TD3WG															
3.1	BU31TD2WNVX	BU31TD3WG															
3.2	BU32TD2WNVX	BU32TD3WG															
3.3	BU33TD2WNVX	BU33TD3WG															
3.4	BU34TD2WNVX	BU34TD3WG															
2.5 to 5.5	±1	280 (I _o =200mA)	0.2	65	10 (I _o =0.01 to 100mA)	40	70	1.0	1.0	✓	✓	✓	✓	BU15TA2W	BU15TA2WNVX	BU15TA2WHFV	
BU18TA2W		BU18TA2WNVX												BU18TA2WHFV			
BU25TA2W		BU25TA2WNVX												BU25TA2WHFV			
BU26TA2W		BU26TA2WNVX												BU26TA2WHFV			
BU27TA2W		BU27TA2WNVX												BU27TA2WHFV			
BU28TA2W		BU28TA2WNVX												BU28TA2WHFV			
BU2JTA2W		BU2JTA2WNVX												BU2JTA2WHFV			
BU29TA2W		BU29TA2WNVX												BU29TA2WHFV			
BU30TA2W		BU30TA2WNVX												BU30TA2WHFV			
BU31TA2W		BU31TA2WNVX												BU31TA2WHFV			
BU32TA2W		BU32TA2WNVX												BU32TA2WHFV			
BU33TA2W		BU33TA2WNVX												BU33TA2WHFV			
BU34TA2W		BU34TA2WNVX												BU34TA2WHFV			
BU33SD2MG-M		1.7 to 6.0												3.30	±2 (T _a =−40 to +105° C)	0.2	85 (I _o =100mA)
BU12SD2MG-M	1.20	400 (I _o =100mA)	SSOP5	YES													
BU15SD2MG-M	1.50	280 (I _o =100mA)	SSOP5	YES													
BU18SD2MG-M	1.80	150 (I _o =100mA)	SSOP5	YES													
BU25SD2MG-M	2.50	100 (I _o =100mA)	SSOP5	YES													
BU28SD2MG-M	2.80	—	SSOP5	YES													
BU30SD2MG-M	3.00	—	SSOP5	YES													

☆ : Under Development

Please ensure that minimum input voltage always exceeds the sum of output voltage and drop out voltage for the device.

6.5V Resistance 200mA CMOS LDO Regulators with Shutdown Switch																			
Type	Input Voltage (V)	Output Voltage (V)	Output Voltage Precision(%)	Output Current (A)	Vsat (mV)	Ripple Rejection (dB)	Load Regulation (mV)	Circuit Current (μA)	Output Short Current (mA)	Input Capacitor (μF)	Output Capacitor (μF)	Shutdown Switch	Over Current Protection	Temperature Protection	Discharge	Package	Automotive Grade AEC-Q100		
BU10JA2MNVX-C	1.7 to 6.0	1.0	±36mV	0.2	800	70	10	35	70	0.47	0.47	✓	✓	✓	✓	SSON004R1010	YES		
BU11JA2MNVX-C		1.1														SSON004R1010	YES		
BU12JA2MNVX-C		1.2														SSON004R1010	YES		
BU1CJA2MNVX-C		1.25														SSON004R1010	YES		
BU15JA2MNVX-C		1.5														SSON004R1010	YES		
BU18JA2MNVX-C		1.8														SSON004R1010	YES		
BU25JA2MNVX-C		2.5	SSON004R1010		YES														
BU28JA2MNVX-C		2.8	SSON004R1010		YES														
BU2JA2MNVX-C		2.85	SSON004R1010		YES														
BU30JA2MNVX-C		3.0	SSON004R1010		YES														
BU33JA2MNVX-C		3.3	SSON004R1010		YES														
BU10JA2VG-C		1.0	±2		160	85	68	0.5	33	100	1.0	1.0	✓	✓	✓	✓	✓	SSOP5	YES
BU12JA2VG-C		1.2																SSOP5	YES
BU1CJA2VG-C		1.25																SSOP5	YES
BU15JA2VG-C	1.5	SSOP5		YES															
BU18JA2VG-C	1.8	SSOP5		YES															
BU25JA2VG-C	2.5	SSOP5		YES															
BU28JA2VG-C	2.8	SSOP5		YES															
BU2JA2VG-C	2.85	SSOP5		YES															
BU30JA2VG-C	3.0	SSOP5		YES															
BU33JA2VG-C	3.3	SSOP5		YES															
BU18JA2DG-C	1.8	160	✓	SSOP5	YES														
BU28JA2DG-C	2.8	85	✓	SSOP5	YES														

6.5V Resistance 200mA CMOS LDO Regulators with Shutdown Switch WL-CSP type																
Part No.	Input Voltage (V)	Output Voltage (V)	Output Voltage Precision(%)	Output Current (A)	Vsat (mV)	Ripple Rejection (dB)	Load Regulation (mV)	Circuit Current (μA)	Output Short Current (mA)	Input Capacitor (μF)	Output Capacitor (μF)	Shutdown Switch	Over Current Protection	Temperature Protection	Discharge Function	Package (mm)
BU18SA4WGWL	1.7 to 5.5	1.8	±2	0.2	100 (Io=150mA)	70	2 (Io=1 to 100mA)	40	100	0.47	0.47	✓	✓	✓	-	UCSP50L1 (0.8×0.8) H=0.55 Max.
BU25SA4WGWL		2.5			UCSP50L1 (0.8×0.8) H=0.55 Max.											
BU2FSA4WGWL		2.55			UCSP50L1 (0.8×0.8) H=0.55 Max.											
BU28SA4WGWL		2.8			UCSP50L1 (0.8×0.8) H=0.55 Max.											
BU30SA4WGWL		3.0			UCSP50L1 (0.8×0.8) H=0.55 Max.											
BU33SA4WGWL		3.3			UCSP50L1 (0.8×0.8) H=0.55 Max.											

6.5V Resistance 150mA CMOS LDO Regulators with Shutdown Switch																
Part No.	Input Voltage (V)	Output Voltage (V)	Output Voltage Precision(%)	Output Current (A)	Vsat (mV)	Ripple Rejection (dB)	Load Regulation (mV)	Circuit Current (μA)	Output Short Current (mA)	Input Capacitor (μF)	Output Capacitor (μF)	Shutdown Switch	Over Current Protection	Temperature Protection	Discharge Function	Package (mm)
BH25NB1WHFV	2.5 to 5.5	2.5	±1	0.15	250 (Io=100mA)	80	6 (Io=1 to 100mA)	60	50	0.1	2.2	✓	✓	✓	-	HVSOF5
BH28NB1WHFV		2.8														HVSOF5
BH2JNB1WHFV		2.85														HVSOF5
BH29NB1WHFV		2.9														HVSOF5
BH30NB1WHFV		3.0														HVSOF5
BH31NB1WHFV		3.1														HVSOF5
BH33NB1WHFV		3.3														HVSOF5

6.5V Resistance 150mA CMOS LDO Regulators with Shutdown Switch																
Part No.	Input Voltage (V)	Output Voltage (V)	Output Voltage Precision(%)	Output Current (A)	Vsat (mV)	Ripple Rejection (dB)	Load Regulation (mV)	Circuit Current (μA)	Output Short Current (mA)	Input Capacitor (μF)	Output Capacitor (μF)	Shutdown Switch	Over Current Protection	Temperature Protection	Discharge Function	Package (mm)
BH15RB1WGUT	2.5 to 5.5	1.5	±25mV	0.15	100 (Io=100mA)	63	2 (Io=1 to 100mA)	34	40	1.0	1.0	✓	✓	✓	-	VCSP60N1 (1.04×1.0) H=0.675 Max.
BH18RB1WGUT		1.8														VCSP60N1 (1.04×1.0) H=0.675 Max.
BH25RB1WGUT		2.5														VCSP60N1 (1.04×1.0) H=0.675 Max.
BH28RB1WGUT		2.8														VCSP60N1 (1.04×1.0) H=0.675 Max.
BH29RB1WGUT		2.9	VCSP60N1 (1.04×1.0) H=0.675 Max.													
BH30RB1WGUT		3.0	VCSP60N1 (1.04×1.0) H=0.675 Max.													
BH31RB1WGUT		3.1	VCSP60N1 (1.04×1.0) H=0.675 Max.													
BH33RB1WGUT		3.3	VCSP60N1 (1.04×1.0) H=0.675 Max.													

6.5V Resistance 150mA CMOS LDO Regulators with Shutdown Switch																												
Part No.	Input Voltage (V)	Output Voltage (V)	Output Voltage Precision(%) (High speed mode)	Output Voltage Precision(%) (Low Icc mode)	Output Current (A)	Vsat (mV)	Ripple Rejection (dB)	Load Regulation (mV)	Circuit Current (μA) (High speed mode)	Circuit Current (μA) (Low Icc mode)	Output Short Current (mA)	Input Capacitor (μF)	Output Capacitor (μF)	Shutdown Switch	Over Current Protection	Temperature Protection	Discharge Function	Package										
BH12PB1WHFV	1.7 to 5.5	1.2	±25mV	-3.3 to +4.3	0.15	-	60 (High speed mode)	10 (Io=10 to 100mA)	20	2	50	0.47	0.47	✓	✓	✓	-	HVSOF5										
BH15PB1WHFV		1.5																HVSOF5										
BH18PB1WHFV		1.8																HVSOF5										
BH25PB1WHFV		2.5	±1	-3.0 to +3.8		210 (Io=100mA)												63	10 (Io=10 to 100mA)	40	50	1.0	1.0	✓	✓	✓	-	HVSOF5
BH28PB1WHFV		2.8																										HVSOF5
BH29PB1WHFV		2.9																										HVSOF5
BH30PB1WHFV		3.0																										HVSOF5
BH31PB1WHFV		3.1																										HVSOF5
BH33PB1WHFV		3.3																										HVSOF5

6.5V Resistance 150mA CMOS LDO Regulators with Shutdown Switch																
Part No.	Input Voltage (V)	Output Voltage (V)	Output Voltage Precision(%)	Output Current (A)	Vsat (mV)	Ripple Rejection (dB)	Load Regulation (mV)	Circuit Current (μA)	Output Short Current (mA)	Input Capacitor (μF)	Output Capacitor (μF)	Shutdown Switch	Over Current Protection	Temperature Protection	Discharge Function	Package
BH18SA3WGUT	2.2 to 5.5	1.8	±25mV	0.15	100 (Io=100mA)	63	2 (Io=1 to 100mA)	40	50	1.0	1.0	✓	✓	✓	-	VCSP60N1
BH28SA3WGUT		2.8														VCSP60N1
BH30SA3WGUT		3.0														VCSP60N1

Power Management

Single-Output LDO Regulators

Please ensure that minimum input voltage always exceeds the sum of output voltage and drop out voltage for the device.

Ultra LDO Type, Fast Transient Response

Part No.	Output Current(A)	Input Voltage(V)		Output Voltage (V)	Voltage Accuracy(%)	Power Good	Adjustable Soft Start	UVLO	OCP	TSD	Package
		V _{CC}	V _{IN}								
BD3550HFN	0.5	4.3 to 5.5	0.95 to (V _{CC} -1)	0.65 to 2.7	±1	—	✓	✓	Recovery	Recovery	HSON8
BD3507HFV	0.55	4.5 to 5.5	1.2 to (V _{CC} -1)								HVSOF6
BD3551HFN	1.0	4.3 to 5.5	0.95 to (V _{CC} -1)	0.65 to 2.5	±1	—	✓	✓	Recovery	Recovery	HSON8
BD3506F	2.5		1.2 to (V _{CC} -1)								SOP8
BD3552HFN	2.0		0.95 to (V _{CC} -1)	0.65 to 2.7	±1	—	✓	✓	Recovery	Recovery	HSON8
BD3508MUV	3.0		0.75 to (V _{CC} -1)								VQFN020V4040
BD3540NUV	0.5	3.0 to 5.5	0.95 to (V _{CC} -1)	0.65 to 2.7	±1	✓	✓	✓	Recovery	Recovery	VSON010V3030
BD3541NUV	1.0		0.95 to (V _{CC} -1)								VSON010V3030
BD3512MUV	3.0	4.3 to 5.5	0.7 to (V _{CC} -1)	0.65 to 2.7	±1	—	✓	✓	Recovery	Latch	VQFN020V4040
BD3509MUV	4.0										VQFN020V4040
BD3504FVM	External FET	4.5 to 5.5	V _{O+} (I _O × R _{on}) to (V _{CC} -1)	0.65 to 2.5	±1	—	✓	✓	Latch	Latch	MSOP8
BD3521FVM	External FET			1.5							MSOP8

Ultra Low Noise LDO for Audio

Part No.	Output Current(A)	Input Voltage(V)	Output Voltage (V)	Reference Voltage Accuracy(%)	Dropout Voltage (mV)	Noise Level (μVrms)	PSRR (dB)	Over Current Protection	Thermal Protection	Package
New BD37201NUX	0.5	2.7 to 5.5	Variable 1.0 to 4.5	±1	200	4.72	90 (f=1KHz) 55 (f=1MHz)	✓	✓	VSON008X2030
☆BD37210MUV	1.0	3.0 to 16.0	Variable 1.0 to 15.0	±1	300	4.6	78(f=1KHz) 53(f=1MHz)	✓	✓	VQFN020V4040
☆BD37215MUV	1.0	-16.0 to -3.0	Variable -15.0 to -1.0	±1	300	5.1	90(f=1KHz) 55(f=1MHz)	✓	✓	VQFN020V4040

 UVLO: Under Voltage Lock Out, OCP: Over Current Protection, TSD: Thermal Shut Down
 ☆: Under Development

LDO Regulators with Voltage Detector and Watchdog Timer
550mA Output LDO Regulators with Voltage Detector and Watchdog Timer

Part No.	Input Voltage (V)	LDO				Voltage Detector			Circuit Current (μA)	Operating Temperature (°C)	Package	Automotive Grade AEC-Q100
		Output Voltage(V)	Output Voltage Precision(%)	Output Current(A)	I/O Voltage Difference(V)	Detection Voltage(V)	Voltage Detection Precision(%)	Function				
BD4271HFP-C	5.5 to 45.0	5	±2 (T _J =-40 to +150°C)	0.55	0.2 (I _O =300mA)	4.65	±2.6	4.65V Voltage Detector+WDT	75	T _J =-40 to +150	HRP7	YES
BD4271FP2-C											TO263-7	YES

500mA Output LDO Regulators with Voltage Detector and Watchdog Timer

BD3021HFP	5.6 to 36.0	5	±2 (T _a =-40 to +125°C)	0.5	0.3 (I _O =200mA)	4.5	±2	4.5V Voltage Detector+WDT(Active switch)	80	T _a =-40 to +125	HRP7	Preparing
BD3020HFP						Variable (at V _s open : 4.1V)		Adjustable Voltage Detector+WDT			HRP7	Preparing

200mA Output LDO Regulators with Voltage Detector and Watchdog Timer

BD3010AFV	5.6 to 36.0	5	±2 (T _a =-40 to +125°C)	0.2	0.25 (I _O =150mA)	Variable (RADJ open: 4.25V)	±3	Adjustable Voltage Detector+WDT	80	-40 to +125	SSOP-B20	Preparing
-----------	-------------	---	---------------------------------------	-----	---------------------------------	--------------------------------	----	---------------------------------	----	-------------	----------	-----------

LDO Regulators with Voltage Detector
500mA Output LDO Regulators with Voltage Detector

Part No.	Input Voltage (V)	LDO				Voltage Detector		Shutdown Switch	Circuit Current (μA)	Operating Temperature (°C)	Package	Automotive Grade AEC-Q100
		Output Voltage(V)	Output Voltage Precision(%)	Output Current(A)	I/O Voltage Difference(V)	Detection Voltage(V)	Voltage Detection Precision(%)					
BD42754FPJ-C	5.5 to 45.0	5	±2 (T _J =-40 to +150°C, V _{CC} =6.0 to 28V, I _O =5mA to 400mA)	0.5	0.25 (I _O =300mA)	4.62V	±2.8	—	75	T _J =-40 to +150	TO252-J5	YES
BD42754FP2-C											TO263-5	YES

200mA/300mA Output LDO Regulators with Voltage Detector

Part No.	Input Voltage (V)	LDO				Voltage Detector		Shutdown Switch	Circuit Current (μA)	Operating Temperature (°C)	Package	Automotive Grade AEC-Q100
		Output Voltage(V)	Output Voltage Precision(%)	Output Current(A)	I/O Voltage Difference(V)	Detection Voltage(V)	Voltage Detection Precision(%)					
BD4269FJ-C	5.5 to 45.0	5	±2 (T _J =-40 to +150°C, V _{CC} =6.0 to 16V, I _O =1mA to 100mA)	0.2	0.25 (I _O =100mA)	Variable (at not used RADJ : 4.62V)	±2.6	—	70	T _J =-40 to +150	SOP-J8	YES
BD4269EFJ-C				0.3							HTSOP-J8	YES

Voltage Tracker
500mA Voltage Tracker

Part No.	Input Voltage (V)	Output Current (A)	Offset Voltage (mV)	Circuit Current (μA)	Operating Temperature (°C)	Package	Automotive Grade AEC-Q100
BD3925FP-C	4.5 to 36.0	0.5	±10(T _a =-40 to +125°C, V _{CC} =6 to 36V, I _O =5 to 200mA)	45	T _a =-40 to +125	TO252-5	Preparing
BD3925HFP-C						HRP5	Preparing

50mA/70mA Voltage Tracker

BD42500G-C	5.3* to 42.0	0.05	±15(T _J =-40 to +150°C, V _{CC} =6 to 40V, I _O =1 to 50mA)	40	T _J =-40 to +150	SSOP5	YES
BD42540FJ-C	5.4* to 42.0	0.07	±10(T _J =-40 to +150°C, V _{CC} =5.5 to 26V, I _O =0.1 to 60mA)	40	T _J =-40 to +150	SOP-J8	YES

250mA Voltage Tracker

BD42530EFJ-C	5.6* to 42.0	0.25	±10(T _J =-40 to +150°C, V _{CC} =6 to 32V, I _O =0.1 to 250mA)	40	T _J =-40 to +150	HTSOP-J8	YES
BD42530FP2-C	5.6* to 42.0	0.25	±10(T _J =-40 to +150°C, V _{CC} =6 to 32V, I _O =0.1 to 250mA)	40	T _J =-40 to +150	TO263-5	YES
BD42530FPJ-C	5.6* to 42.0	0.25	±10(T _J =-40 to +150°C, V _{CC} =6 to 32V, I _O =0.1 to 250mA)	40	T _J =-40 to +150	TO252-J5	YES

*5V setting

Multi-Output LDO Regulators

Please ensure that minimum input voltage always exceeds the sum of output voltage and drop out voltage for the device.

2ch LDO Regulators															
Part No.	Input Voltage (V)	Output Voltage1 (V)	Output Voltage2 (V)	Output voltage Precision (%)	Output Current (A)	Bias Current (mA)	I/O Voltage Difference (V)	Ripple Rejection (dB)	Load Regulation (mV)	Input Capacitor (μF)	Output Capacitor (μF)	Shut Down Switch	Protection Circuit	Package	
BA30E00WHFP	4.1 to 16.0	3.3	Variable 0.8 to 3.3	±2.0	0.6/0.6	0.7	0.3 (I _o =300mA)	68 (3.3V output)	30 (I _o =0 to 0.6A)	1.0	47	✓	Over-Current/ Temperature	HRP7	
BA3259HFP	4.75 to 14.0				1.0/1.0	3.0	1.1 (I _o =1A)	52	5 (I _o =5mA to 1A)	3.3	1.0	—		—	HRP5
BA33D15HFP	4.1 to 16.0	3.3	1.5		0.5/0.5	0.7	0.25 (I _o =250mA)	58 (1.5V output)	30 (I _o =0 to 500mA)	1.0	1.0	—		—	HRP5
BA33D18HFP			1.8		—	—	—	—	—	—	—	—		HRP5	

2ch High Efficiency CMOS Regulator													
Part No.	Output Voltage (V)	Output Voltage Precision (%)	Output Current (A)	Ripple Rejection (dB)	Load Regulation (%)	Output Short Current (mA)	Output Capacitor (μF)	Shut Down Switch	Over Current Protection	Temperature Protection	Discharge Function		
BD70511GWL	LDO1	1.2	1.5	0.15	60	10	1.0	✓	✓	✓	✓	✓	✓
	LDO2			0.3									

2ch Variable Step CMOS LDO Regulators																									
Part No.	Input Voltage (V)	Selectable Output Voltage (V)										Output Voltage Precision (%)	Output Current (A)	Vs _{sat} (mV) (I _o =100mA)	Ripple Rejection (dB)	Load Regulation (%)	Circuit Current (μA)	Output Short Current (mA)	Input Capacitor (μF)	Output Capacitor (μF)	Shut Down Switch	Over Current Protection	Temperature Protection	Low Voltage Protection	
		1ch	1.5	1.8	1.8	1.8	1.8	2.6	2.8	2.9	2.8														
BD7003NUX	2.5 to 5.5	2ch	2.8	2.6	2.7	2.8	2.9	2.8	2.8	2.9	3.3	1.8	0.3	90	66	0.2 (I _o =1 to 300mA)	55	150	1.0	1.0	✓	✓	✓	✓	✓
		1ch	1.2	1.2	1.8	1.8	1.8	1.8	2.8	3.0	3.3														
BD7602GUL	2.7 to 5.5	1ch	3.0										2.0	0.15	—	45	0.7	10	—	1.0	4.7	✓	✓	✓	✓
		2ch	2.8	2.9	2.95	3.0	3.05	3.1	3.2	3.3	—														

3ch CMOS LDO Regulators																			
Part No.	Input Voltage (V)	Output Voltage (V)	Output Voltage Precision	Output Current (A)	Vs _{sat} (mV) (I _o =200mA)	Ripple Rejection (dB)	Load Regulation (%)	ch	Circuit Current (μA)	Output Short Current (mA)	Input Capacitor (μF)	Output Capacitor (μF)	Shut Down Switch	Over Current Protection	Temperature Protection	Discharge Function	Package		
																		2.8	±1%
BU6650NUX	2.5 to 5.5	2.8	±1%	0.2	360	65	10 (I _o =1 to 100mA)	1	120	70	2.2	1.0	✓	✓	✓	✓	VSON008X2030		
		2.8	±1%					360										65	2
		1.8	±25mV					—										70	3
BU6651NUX	2.5 to 5.5	2.8	±1%	0.2	360	65	10 (I _o =1 to 100mA)	1	120	70	2.2	1.0	✓	✓	✓	✓	VSON008X2030		
		1.8	±25mV					—										70	3
		1.5	±25mV					—										70	3
BU6652NUX	2.5 to 5.5	2.8	±1%	0.2	360	65	10 (I _o =1 to 100mA)	1	120	70	2.2	1.0	✓	✓	✓	✓	VSON008X2030		
		2.8	±1%					360										65	2
		1.5	±25mV					—										70	3
BU6653NUX	2.5 to 5.5	2.8	±1%	0.2	360	65	10 (I _o =1 to 100mA)	1	120	70	2.2	1.0	✓	✓	✓	✓	VSON008X2030		
		2.8	±1%					360										65	2
		1.8	±25mV					—										70	3
BU6654NUX	2.5 to 5.5	3.3	±1%	0.2	300	65	10 (I _o =1 to 100mA)	1	120	70	2.2	1.0	✓	✓	✓	✓	VSON008X2030		
		1.8	±25mV					—										70	2
		1.5	±25mV					—										70	3
BU6655NUX	2.5 to 5.5	3.3	±1%	0.2	300	65	10 (I _o =1 to 100mA)	1	120	70	2.2	1.0	✓	✓	✓	✓	VSON008X2030		
		2.8	±1%					360										65	2
		1.8	±25mV					—										70	3

Linear Regulators for DDR SDRAM

Termination Regulators for DDR SDRAM																										
Part No.	V _{CC} Input Voltage (V)	V _{TT,IN} Termination Input Voltage (V)	V _{DDO} Reference Input Voltage (V)	V _{TT} Output Voltage (V)	V _{TT} Voltage Precision (mV)	V _{TT} Output Current (A)	V _{REF} Output Current (mA)	Features														Package				
								Enable	Soft Start	Power Good	UVLO	Output Ceramic Capacitors	Thermal Protection	DDR(VDDQ)												
								DDR1 (2.5V/2.6V)	DDR2 (1.8V)	DDR2L (1.5V)	LPDDR2 (1.2V)	DDR3 (1.5V)	DDR3L (1.35V)	DDR3U (1.25V)	LPDDR3 (1.2V)	DDR4 (1.2V)										
BD3533F	2.7 to 5.5	1.0 to 5.5	1.0 to 2.75	0.75 to 1.25	±30	±1.0	±20	✓	✓	—	✓	—	Recovery	✓	✓	—	—	—	—	—	—	SOP8				
BD3533FVM								MSOP8																		
BD3533HFN								HSOP8																		
BD3539FVM								MSOP8																		
BD3539NUX								VSON008X2030																		
BD35390FJ	2.7 to 5.5	1.0 to 5.5	1.0 to 2.75	0.75 to 1.25	±15	±1.0	—	✓	✓	✓	✓	✓	Recovery	✓	✓	✓	—	✓	—	—	—	SOP-J8				
Part No.	V _{CC} Input Voltage (V)	V _{TT,IN} Termination Input Voltage (V)	V _{DDO} Reference Input Voltage (V)	V _{TT} Output Voltage (V)	V _{TT} Voltage Precision (mV)	V _{TT} Output Current (A)	V _{REF} Output Current (mA)	Enable	Soft Start	Power Good	UVLO	Output Ceramic Capacitors	Thermal Protection	Features										Package	Automotive Grade AEC-Q100	
								DDR1 (2.5V/2.6V)	DDR2 (1.8V)	DDR2L (1.5V)	LPDDR2 (1.2V)	DDR3 (1.5V)	DDR3L (1.35V)	DDR3U (1.25V)	LPDDR3 (1.2V)	DDR4 (1.2V)										
BD35395FJ-M	2.7 to 5.5	1.0 to 5.5	1.0 to 2.75	0.5 to 1.375	±13.5	±1.0	—	✓	✓	✓	✓	✓	Recovery	✓	✓	✓	—	✓	✓	—	—	—	SOP-J8	YES		

A Power Management

Switching Regulators

Switching Regulators

Integrated MOSFET Switching Regulators

Single Output Buck Converters $V_{IN} \leq 6V$ ▶ P.A49

Single Output Buck Converters $V_{IN} \leq 20V$ ▶ P.A50

Single Output Buck Converters $V_{IN} \geq 20V$ ▶ P.A50

Dual Output Buck Converters ▶ P.A51

Boost and Buck-Boost Converters ▶ P.A51

External Switch Switching Regulators

Buck Controllers ▶ P.A51

Boost and Buck-Boost Converters ▶ P.A51

For Automotive Switching Regulators

Switching Regulators (Integrated Switch) Single Output ▶ P.A52

Switching Regulators (Integrated Switch) Ultra Low Quiescent Current / Synchronous Rectification ▶ P.A52

Switching Regulators (Integrated Switch) High Voltage/Synchronous Rectification ▶ P.A52

Secondary Switching Regulators (Integrated Switch) Single Output ▶ P.A52

Switching Controllers (External Switch) Dual Output Buck / Boost Converters ▶ P.A52

Switching Controllers (External Switch) Single Output Buck / Boost Converters ▶ P.A52

Switching Regulators

Integrated MOSFET Switching Regulators

Single Output Buck Converters $V_{IN} \leq 6V$														
Part No.	Input Voltage Maximum Rating (V)	Output Current (A)	Input Voltage (V)	Output Voltage (V)	Switching Frequency (MHz)	Control Mode	Features						Package (mm)	
							Power Good	Adjustable Soft Start	Synchronous Rectifier	Light-Load Efficiency	Over-Current Protection	Thermal Protection		
BD9122GUL	7	0.3	2.5 to 5.5	1.0 to 2.0	1	Current	—	—	✓	✓	Latch	Latch	VCSP50L2 (2.5×1.1, h:0.55)	
New BD70522GUL	6	0.5	2.7 to 5.5	1.2 to 3.3*	1	On-time	✓	—	✓	✓	Recovery	Recovery	VCSP50L1C (1.76×1.56, h:0.57)	
BD9161FVM	7	0.6	2.5 to 4.5	1.0 to 3.3	1	Current	—	—	✓	✓	Latch	Latch	MSOP8	
BD9161FVM-LB	7	0.6	2.5 to 4.5	1.0 to 3.3	1	Current	—	—	✓	✓	Latch	Latch	MSOP8	
BU9006GUZ	7	0.75	2.5 to 4.5	1.0 to V_{IN}	2	Current	—	—	✓	—	Recovery	Recovery	VCSP35L1 (1.6×1.6, h:0.4)	
BD9109FVM	7	0.8	4.5 to 5.5	3.3	1	Current	—	—	✓	✓	Latch	Latch	MSOP8	
BD9109FVM-LB	7	0.8	4.5 to 5.5	3.3	1	Current	—	—	✓	✓	Latch	Latch	MSOP8	
BD9102FVM	7	0.8	4.0 to 5.5	1.24	1	Current	—	—	✓	✓	Latch	Latch	MSOP8	
BD8966FVM	7	0.8	4.0 to 5.5	1.0 to 2.5	1	Current	—	—	✓	—	Latch	Latch	MSOP8	
BD9106FVM	7	0.8	4.0 to 5.5	1.0 to 2.5	1	Current	—	—	✓	✓	Latch	Latch	MSOP8	
BD9106FVM-LB	7	0.8	4.0 to 5.5	1.0 to 2.5	1	Current	—	—	✓	✓	Latch	Latch	MSOP8	
BD9120HFN	7	0.8	2.7 to 4.5	1.0 to 1.5	1	Current	—	—	✓	✓	Latch	Latch	HSOP8	
BD8967FVM	7	0.8	4.5 to 5.5	3.3	1	Current	—	—	✓	—	Latch	Latch	MSOP8	
BD9104FVM	7	0.8	4.5 to 5.5	3.3	1	Current	—	—	✓	✓	Latch	Latch	MSOP8	
BU90008GWZ	7	1	2.3 to 5.5	1.0	3.6	On-time	—	—	✓	✓	Recovery	Recovery	UCSP35L1 (1.3×0.9, h:0.4)	
BU90003GWZ	7	1	2.3 to 5.5	1.2	4	On-time	—	—	✓	✓	Recovery	Recovery	UCSP35L1 (1.3×0.9, h:0.4)	
BU90007GWZ	7	1	2.3 to 5.5	1.25	4	On-time	—	—	✓	✓	Recovery	Recovery	UCSP35L1 (1.3×0.9, h:0.4)	
BU90009GWZ	7	1	2.3 to 5.5	1.3	4.2	On-time	—	—	✓	✓	Recovery	Recovery	UCSP35L1 (1.3×0.9, h:0.4)	
BU90004GWZ	7	1	2.3 to 5.5	1.8	5.4	On-time	—	—	✓	✓	Recovery	Recovery	UCSP35L1 (1.3×0.9, h:0.4)	
BU90054GWZ	7	1	2.3 to 5.5	1.8	5.4	On-time	—	—	✓	✓	Recovery	Recovery	UCSP30L1 (1.3×0.9, h:0.33)	
BU90104GWZ	7	1	2.3 to 5.5	1.8	5.4	On-time	—	—	✓	✓	Recovery	Recovery	UCSP35L1 (1.3×0.9, h:0.4)	
BU90090GWZ	7	1	2.3 to 5.5	1.83	5.4	On-time	—	—	✓	✓	Recovery	Recovery	UCSP35L1 (1.3×0.9, h:0.4)	
BU90005GWZ	7	1	2.3 to 5.5	2.5	6	On-time	—	—	✓	✓	Recovery	Recovery	UCSP35L1 (1.3×0.9, h:0.4)	
BU90006GWZ	7	1	2.3 to 5.5	3.0	6	On-time	—	—	✓	✓	Recovery	Recovery	UCSP35L1 (1.3×0.9, h:0.4)	
BU90002GWZ	7	1	4.0 to 5.5	3.3	6	On-time	—	—	✓	✓	Recovery	Recovery	UCSP35L1 (1.3×0.9, h:0.4)	
BD9A100MUV	7	1	2.7 to 5.5	0.8 to ($V_{IN} \times 0.7$)	1	Current	✓	✓	✓	✓	Recovery	Recovery	VQFN016V3030	
BD9A101MUV-LB	7	1	2.7 to 5.5	0.8 to ($V_{IN} \times 0.7$)	1	Current	✓	✓	✓	✓	Recovery	Recovery	VQFN016V3030	
BD9B100MUV	7	1	2.7 to 5.5	0.8 to ($V_{IN} \times 0.8$)	2/1	On-time	✓	✓	✓	✓	Deep	Recovery	VQFN016V3030	
BD8964FVM	7	1.2	4.0 to 5.5	1.0 to 1.8	1	Current	—	—	✓	—	Latch	Latch	MSOP8	
BD9107FVM	7	1.2	4.0 to 5.5	1.0 to 1.8	1	Current	—	—	✓	✓	Latch	Latch	MSOP8	
BD9123MUV	7	1.2	2.7 to 5.5	0.85 to 1.2	1	Current	✓	—	✓	✓	Latch	Latch	VQFN016V3030	
BU90023NUX	7	1.5	2.3 to 5.5	1.23	1	On-time	—	—	✓	✓	Recovery	Recovery	VSON008X2030	
BU90028NUX	7	1.5	2.3 to 5.5	1.18	1	On-time	—	—	✓	✓	Recovery	Recovery	VSON008X2030	
BD8961NV	7	2	4.5 to 5.5	3.3	1	Current	—	—	✓	—	Latch	Latch	SON008V5060	
BD9111NV	7	2	4.5 to 5.5	3.3	1	Current	—	—	✓	✓	Latch	Latch	SON008V5060	
BD9110NV	7	2	4.5 to 5.5	1.0 to 2.5	1	Current	—	—	✓	✓	Latch	Latch	SON008V5060	
BD89630EFJ	7	2	2.7 to 5.5	1.0 to 2.5*	1	Current	—	—	✓	—	Latch	Latch	HTSOP-J8	
BD8960NV	7	2	2.7 to 5.5	1.0 to 2.5*	1	Current	—	—	✓	—	Latch	Latch	SON008V5060	
BD9130NV	7	2	2.7 to 5.5	1.0 to 2.5*	1	Current	—	—	✓	✓	Latch	Latch	SON008V5060	
BD9B200MUV	7	2	2.7 to 5.5	0.8 to ($V_{IN} \times 0.8$)	2/1	On-time	✓	✓	✓	✓	Deep	Recovery	VQFN016V3030	
BD8962MUV	7	3	2.7 to 5.5	0.8 to 2.5*	1	Current	—	—	✓	—	Latch	Latch	VQFN020V4040	
BD9132MUV	7	3	2.7 to 5.5	0.8 to 3.3*	1	Current	—	—	✓	✓	Latch	Latch	VQFN020V4040	
BD8963EFJ	7	3	2.7 to 5.5	1.0 to 2.5*	1	Current	—	—	✓	—	Latch	Latch	HTSOP-J8	
BD9134MUV	7	3	4.5 to 5.5	3.3	1	Current	—	—	✓	✓	Latch	Latch	VQFN020V4040	
BD9139MUV	7	3	2.7 to 5.5	0.8 to 3.3*	1	Current	—	—	✓	✓	Latch	Latch	VQFN016V3030	
BD9A300MUV	7	3	2.7 to 5.5	0.8 to ($V_{IN} \times 0.7$)	1	Current	✓	✓	✓	✓	Recovery	Recovery	VQFN016V3030	
BD9A301MUV-LB	7	3	2.7 to 5.5	0.8 to ($V_{IN} \times 0.7$)	1	Current	✓	✓	✓	✓	Recovery	Recovery	VQFN016V3030	
BD9B300MUV	7	3	2.7 to 5.5	0.8 to ($V_{IN} \times 0.8$)	2/1	On-time	✓	✓	✓	✓	Deep	Recovery	VQFN016V3030	
BD9B301MUV-LB	7	3	2.7 to 5.5	0.8 to ($V_{IN} \times 0.8$)	2/1	On-time	✓	✓	✓	✓	Deep	Recovery	VQFN016V3030	
New BD9A302QWZ	7	3	2.7 to 5.5	0.8 to ($V_{IN} \times 0.7$)	1	Current	—	—	✓	✓	Recovery	Recovery	UMMP008AZ020 (2.0×2.0, h:0.4)	
New BD9B304QWZ	7	3	2.7 to 5.5	0.8 to ($V_{IN} \times 0.8$)	2/1	On-time	—	—	✓	✓	Deep	Recovery	Recovery	UMMP008AZ020 (2.0×2.0, h:0.4)
New BD9B331GWZ	7	3	2.7 to 5.5	0.6 to ($V_{IN} \times 0.8$)	1.3	On-time	✓	✓	✓	✓	Latch	Recovery	UCSP30L1 (1.98×1.8, h:0.33)	
New BD9B333GWZ	7	3	2.7 to 5.5	0.6 to ($V_{IN} \times 0.8$)	1.3	On-time	✓	✓	✓	✓	Deep	Recovery	Recovery	UCSP35L1 (1.98×1.8, h:0.4)
BD9137MUV	7	4	2.7 to 5.5	0.8 to 3.3*	1	Current	—	—	✓	✓	Recovery	Recovery	VQFN020V4040	
BD91361MUV	7	4	2.7 to 5.5	0.8 to 3.3*	1	Current	—	—	✓	✓	Latch	Latch	VQFN020V4040	
BD9A400MUV	7	4	2.7 to 5.5	0.8 to ($V_{IN} \times 0.7$)	1	Current	✓	✓	✓	✓	Recovery	Recovery	VQFN016V3030	
BD9B400MUV	7	4	2.7 to 5.5	0.8 to ($V_{IN} \times 0.8$)	2/1	On-time	✓	✓	✓	✓	Deep	Recovery	VQFN016V3030	
BD91364BMUU	7	5	2.9 to 5.5	0.8 to ($V_{IN} \times 0.8$)	1.7	On-time	✓	✓	✓	✓	Latch	Recovery	VQFN20U4040M	
BD9B500MUV	7	5	2.7 to 5.5	0.8 to ($V_{IN} \times 0.8$)	2/1	On-time	✓	✓	✓	✓	Deep	Recovery	Recovery	VQFN016V3030
BD9A600MUV	7	6	2.7 to 5.5	0.8 to ($V_{IN} \times 0.7$)	1	Current	✓	✓	✓	✓	Recovery	Recovery	VQFN016V3030	
BD9B600MUV	7	6	2.7 to 5.5	0.8 to ($V_{IN} \times 0.8$)	2/1	On-time	✓	✓	✓	✓	Deep	Recovery	Recovery	VQFN016V3030

*:Restrictions depend on input/output voltage conditions.

Integrated MOSFET Switching Regulators
Single Output Buck Converters $V_{IN} \leq 20V$

Part No.	Input Voltage Maximum Rating(V)	Output Current (A)	Input Voltage (V)	Output Voltage (V)	Switching Frequency (MHz)	Control Mode	Features						Package (mm)	
							Power Good	Adjustable Soft Start	Synchronous Rectifier	Light-Load Efficiency	Over-Current Protection	Thermal Protection		Over-Voltage Protection
BD8312HFN	15	0.8	3.5 to 14	1.2 to 12*	1.5	Current	—	—	✓	—	—	Recovery	—	HS0N8
BD9227F	22	1	6 to 20	$(V_{IN} \times 0.252)$ to V_{IN} $(V_{IN} \times 0.252) \geq 1.0$	1	Current	—	—	—	—	Recovery	Recovery	—	SOP8
BD8313HFN	15	1	3.5 to 14	1.2 to 12*	1	Current	—	—	✓	—	—	Recovery	—	HS0N8
BD9328EFJ	20	2	4.2 to 18	0.9 to $(V_{IN} \times 0.7)$	0.4	Current	—	✓	✓	—	Recovery	Recovery	—	HTSOP-J8
BD9328EFJ-LB	20	2	4.2 to 18	0.9 to $(V_{IN} \times 0.7)$	0.4	Current	—	✓	✓	—	Recovery	Recovery	—	HTSOP-J8
BD9141MUV	15	2	4.5 to 13.2	2.5 to 6.0*	0.5	Current	—	—	✓	✓	Latch	Latch	—	VQFN020V4040
BD95821MUV	15.2	2	7.5 to 15	0.8 to $(V_{IN} \times 0.5)$ $(V_{IN} \times 0.5) \leq 5.5$	0.5 to 0.8	H ³ Reg	✓	—	✓	—	Latch	Recovery	✓	VQFN016V3030
BD9325FJ	20	2	4.75 to 18	0.9 to $(V_{IN} \times 0.9)$	0.4	Current	—	✓	—	—	Recovery	Recovery	—	SOP-J8
BD9325FJ-LB	20	2	4.75 to 18	0.9 to $(V_{IN} \times 0.9)$	0.4	Current	—	✓	—	—	Recovery	Recovery	—	SOP-J8
BD9329AEFJ	20	3	4.2 to 18	0.9 to $(V_{IN} \times 0.7)$	0.4	Current	—	✓	✓	—	Recovery	Recovery	—	HTSOP-J8
BD9329AEFJ-LB	20	3	4.2 to 18	0.9 to $(V_{IN} \times 0.7)$	0.4	Current	—	✓	✓	—	Recovery	Recovery	—	HTSOP-J8
BD9C301FJ	20	3	4.5 to 18	$(V_{IN} \times 0.125)$ to $(V_{IN} \times 0.7)$	0.5	Current	—	—	✓	—	Latch	Recovery	—	SOP-J8
BD9C301FJ-LB	20	3	4.5 to 18	$(V_{IN} \times 0.125)$ to $(V_{IN} \times 0.7)$	0.5	Current	—	—	✓	—	Latch	Recovery	—	SOP-J8
BD95831MUV	15.2	3	7.5 to 15	0.8 to $(V_{IN} \times 0.5)$ $(V_{IN} \times 0.5) \leq 5.5$	0.5 to 0.8	H ³ Reg	✓	—	✓	—	Latch	Recovery	✓	VQFN016V3030
BD9D320EFJ	20	3	4.5 to 18	0.765 to 7.0 $(V_{IN} \times 0.07)$ to $(V_{IN} \times 0.65)$	0.7	On-time	—	✓	✓	—	Recovery	Recovery	—	HTSOP-J8
BD9D321EFJ	20	3	4.5 to 18	0.765 to 7.0 $(V_{IN} \times 0.07)$ to $(V_{IN} \times 0.65)$	0.7	On-time	—	✓	✓	✓	Recovery	Recovery	—	HTSOP-J8
New BD9D322QWZ	20	3	4.5 to 18	0.765 to 7.0 $(V_{IN} \times 0.07)$ to $(V_{IN} \times 0.65)$	0.7	On-time	—	✓	✓	✓	Recovery	Recovery	—	UMMP008Z2020 (2.0 × 2.0, h:0.4)
New BD9D323QWZ	20	3	4.5 to 18	0.765 to 7.0 $(V_{IN} \times 0.07)$ to $(V_{IN} \times 0.65)$	0.7	On-time	—	✓	✓	—	Recovery	Recovery	—	UMMP008Z2020 (2.0 × 2.0, h:0.4)
BD9859EFJ	15	3	5.0 to 14	1.0 to $(V_{IN} \times 0.7)$	0.8	Current	—	—	—	—	Recovery	Recovery	—	HTSOP-J8
BD9326EFJ	20	3	4.75 to 18	0.9 to $(V_{IN} \times 0.9)$	0.4	Current	—	✓	—	—	Recovery	Recovery	—	HTSOP-J8
BD9326EFJ-LB	20	3	4.75 to 18	0.9 to $(V_{IN} \times 0.9)$	0.4	Current	—	✓	—	—	Recovery	Recovery	—	HTSOP-J8
BD9C401EFJ	20	4	4.5 to 18	$(V_{IN} \times 0.125)$ to $(V_{IN} \times 0.7)$ $(V_{IN} \times 0.125) \geq 0.8$	0.5	Current	—	—	✓	—	Latch	Recovery	—	HTSOP-J8
BD95841MUV	15.2	4	7.5 to 15	0.8 to $(V_{IN} \times 0.5)$ $(V_{IN} \times 0.5) \leq 5.5$	0.5 to 0.8	H ³ Reg	✓	—	✓	—	Latch	Recovery	✓	VQFN016V3030
BD9327EFJ	20	4	4.75 to 18	0.9 to $(V_{IN} \times 0.9)$	0.4	Current	—	✓	—	—	Recovery	Recovery	—	HTSOP-J8
BD9327EFJ-LB	20	4	4.75 to 18	0.9 to $(V_{IN} \times 0.9)$	0.4	Current	—	✓	—	—	Recovery	Recovery	—	HTSOP-J8
BD9C501EFJ	20	5	4.5 to 18	$(V_{IN} \times 0.075)$ to $(V_{IN} \times 0.7)$ $(V_{IN} \times 0.075) \geq 0.8$	0.5	Current	—	—	✓	—	Latch	Recovery	—	HTSOP-J8
BD95861MUV	20	6	7.5 to 18	0.8 to $(V_{IN} \times 0.5)$ $(V_{IN} \times 0.5) \leq 5.5$	0.35 to 0.8	H ³ Reg	✓	—	✓	—	Latch	Recovery	✓	VQFN024V4040
BD9C601EFJ	20	6	4.5 to 18	$(V_{IN} \times 0.075)$ to $(V_{IN} \times 0.7)$ $(V_{IN} \times 0.075) \geq 0.8$	0.5	Current	—	—	✓	—	Latch	Recovery	—	HTSOP-J8
BD95500MUV	24	6	3.0 to 20	0.7 to 5	0.2 to 1	H ³ Reg	✓	✓	✓	✓	Latch	Recovery	✓	VQFN040V6060

Single Output Buck Converters $V_{IN} \geq 20V$

BD9G101G	45	0.5	6.0 to 42	$(V_{IN} \times 0.15)$ to $(V_{IN} \times 0.7)$ $(V_{IN} \times 0.15) \geq 1.0$	1.5	Current	—	—	—	—	Recovery	Recovery	—	SSOP6
BD9E100FJ-LB	40	1	7.0 to 36	$(V_{IN} \times 0.15)$ to $(V_{IN} \times 0.7)$ $(V_{IN} \times 0.15) \geq 1.0$	1	Current	—	—	✓	—	Recovery	Recovery	✓	SOP-J8
BD9E101FJ-LB	40	1	7.0 to 36	$(V_{IN} \times 0.0855)$ to $(V_{IN} \times 0.7)$ $(V_{IN} \times 0.0855) \geq 1.0$	0.6	Current	—	—	✓	—	Recovery	Recovery	✓	SOP-J8
BD9E102FJ	30	1	7.0 to 26	$(V_{IN} \times 0.143)$ to $(V_{IN} \times 0.7)$ $(V_{IN} \times 0.143) \geq 1.0$	0.6	Current	—	—	✓	✓	Recovery	Recovery	✓	SOP-J8
New BD9V101MUF-LB	70	1	16 to 60	0.8 to 5.5	1.9 to 2.3	Current	✓	—	✓	—	Recovery	Recovery	✓	VQFN24FV4040
BD9E151NUX	30	1.2	6.0 to 28	$(V_{IN} \times 0.06)$ to $(V_{IN} \times 0.7)$ $(V_{IN} \times 0.06) \geq 1.0$ *	0.6	Current	—	✓	—	—	Recovery	Recovery	✓	VSON008X2030
BD9701CP-V5	36	1.5	8.0 to 35	1.0 to $(V_{IN}-3.0)$	0.1	Voltage	—	—	—	—	Recovery	Recovery	—	TO220CP-V5
BD9701FP	36	1.5	8.0 to 35	1.0 to $(V_{IN}-3.0)$	0.1	Voltage	—	—	—	—	Recovery	Recovery	—	TO252-5
BD9703CP-V5	36	1.5	8.0 to 35	1.0 to $(V_{IN}-3.0)$	0.3	Voltage	—	—	—	—	Recovery	Recovery	—	TO220CP-V5
BD9703FP	36	1.5	8.0 to 35	1.0 to $(V_{IN}-3.0)$	0.3	Voltage	—	—	—	—	Recovery	Recovery	—	TO252-5
BD9870FPS	36	1.5	8.0 to 35	1.0 to $(0.8 \times (V_{IN}-I_{OL} \times R_{OL}))$	0.9	Voltage	—	—	—	—	Recovery	Recovery	—	TO252S-5
BD9873CP-V5	36	1.5	8.0 to 35	1.0 to $(0.8 \times (V_{IN}-I_{OL} \times R_{OL}))$	0.1	Voltage	—	—	—	—	Recovery	Recovery	—	TO220CP-V5
BD9778HFP	36	2	7.0 to 35	$(V_{IN} \times 0.06)$ to V_{IN} $(V_{IN} \times 0.06) \geq 1.0$	0.05 to 0.5	Voltage	—	—	—	—	Recovery	Recovery	—	HRP7
BD9E300EFJ-LB	40	2.5	7.0 to 36	$(V_{IN} \times 0.15)$ to $(V_{IN} \times 0.7)$ $(V_{IN} \times 0.15) \geq 1.0$	1	Current	—	—	✓	—	Recovery	Recovery	✓	HTSOP-J8
BD9E301EFJ-LB	40	2.5	7.0 to 36	$(V_{IN} \times 0.0855)$ to $(V_{IN} \times 0.7)$ $(V_{IN} \times 0.0855) \geq 1.0$	0.6	Current	—	—	✓	—	Recovery	Recovery	✓	HTSOP-J8
BD9E303EFJ-LB	40	3	7.0 to 36	$(V_{IN} \times 0.06)$ to $(V_{IN} \times 0.8)$ $(V_{IN} \times 0.06) \geq 1.0$	0.3	Current	—	—	✓	—	Recovery	Recovery	✓	HTSOP-J8
BD9702CP-V5	36	3	8.0 to 35	1.0 to $(V_{IN}-3.0)$	0.1	Voltage	—	—	—	—	Recovery	Recovery	—	TO220CP-V5
BD9874CP-V5	36	3	8.0 to 35	1.0 to $(0.8 \times (V_{IN}-I_{OL} \times R_{OL}))$	0.1	Voltage	—	—	—	—	Recovery	Recovery	—	TO220CP-V5
BD9E302EFJ	30	3	7.0 to 28	$(V_{IN} \times 0.11)$ to $(V_{IN} \times 0.7)$ $(V_{IN} \times 0.11) \geq 1.0$	0.6	Current	—	—	✓	✓	Recovery	Recovery	✓	HTSOP-J8
BD95513MUV	30	3	4.5 to 28	0.7 to 5.0	0.2 to 1	H ³ Reg	✓	✓	✓	✓	Latch	Recovery	✓	VQFN032V5050
BD9G341AEFJ	80	3	12 to 76	1.0 to $(V_{IN} \times 0.7)$ *	0.05 to 0.75	Current	—	—	—	—	Recovery	Recovery	✓	HTSOP-J8
BD9G341AEFJ-LB	80	3	12 to 76	1.0 to $(V_{IN} \times 0.7)$ *	0.05 to 0.75	Current	—	—	—	—	Recovery	Recovery	✓	HTSOP-J8
BD95514MUV	30	4	4.5 to 28	0.7 to 5.0	0.2 to 1	H ³ Reg	✓	✓	✓	✓	Latch	Recovery	✓	VQFN032V5050

*:Restrictions depend on input/output voltage conditions.

Dual Output Buck Converters														
Part No.	Number of Channels	Input Voltage Maximum Rating (V)	Output Current (A)	Input Voltage Range (V)	Output Voltage (V)	Switching Frequency (MHz)	Control Mode	Features					Description	Package
								Synchronous Rectifier	Light-Load Efficiency	Over-Current Protection	Thermal Protection	Over-Voltage Protection		
BD91501MUV	2	7	Io1 : 0.4 Io2 : 0.3	2.55 to 5.5	Vo1 : 2.55 Vo2 : 1.80	1.65	Current	✓	✓	Latch	Recovery	—	100% Duty	VQFN016V3030
BD9151MUV	2	7	Io1 : 0.4 Io2 : 0.8	2.8 to 5.5	Vo1 : 1.8 Vo2 : 1.2	1	Current	✓	✓	Latch	Latch	—	Voltage Detector, High-side gate controller	VQFN020V4040
BD9152MUV	2	7	Io1 : 1.5 Io2 : 1.5	4.5 to 5.5	Vo1 : 3.3 Vo2 : 0.8 to 2.5	1	Current	✓	✓	Latch	Latch	—	—	VQFN020V4040
BD93291EFJ	2	30	Io1 : 2.5 Io2 : 1.5	8.0 to 26	Vo1 : 5.0 Vo2 : 0.8 to 4.0	1.5 to 2.5	H ³ Reg	✓	✓	Recovery	Recovery	—	—	HTSOP-J8
BD95830MUV	2	15.1	Io1 : 3.0 Io2 : 3.0	7.5 to 15	Vo1 : 0.8 to 5.5 Vo2 : 0.8 to 5.5	0.4 to 0.8	H ³ Reg	✓	—	Latch	Recovery	Latch	—	VQFN032V5050

Boost and Buck-Boost Converters																		
Part No.	Number of Channels	Switch Current Limit (mA)	Input Voltage (V)	Output Voltage (V)	Switching Frequency (kHz)	Control Mode	Features										Package	
							Boost	Buck-Boost	SEPIC	Inverting	Synchronous Rectifier	Light-Load Efficiency	Soft Start	Input Pass through	UVLO	Over-Current Protection		Thermal Protection
BU33DV5G	1	10	1.75 to 4.5	3.3	100	Current	✓	—	—	—	✓	—	—	—	✓	Recovery	✓	SSOP5
BU33DV7NUX	1	300	1.8 to 5.5	3.3	600	Current	✓	—	—	—	✓	✓	✓	✓	✓	Recovery	✓	VSON010V3030
BU34DV7NUX	1	300	1.8 to 5.5	3.4	600	Current	✓	—	—	—	✓	✓	✓	✓	✓	Recovery	✓	VSON010V3030
New BU33UV7NUX	1	500	0.6 to 4.5	3.3	800	Current	✓	—	—	—	✓	✓	✓	✓	✓	Recovery	✓	VSON010X3020
BD8316GWL	2	1,000	2.5 to 5.5	Vo1 : -9.0 to -1.0 Vo2 : V _{IN} to 18	1,600	Current	✓	—	—	✓	—	—	—	—	✓	Latch	✓	UCSP50L1
BD8317GWL	2	1,000	2.5 to 5.5	Vo1 : -9.0 to -1.0 Vo2 : V _{IN} to 18	800	Current	✓	—	—	✓	—	—	—	—	✓	Latch	✓	UCSP50L1
BD8152FVM	1	1,400	2.5 to 5.5	V _{IN} to 14	600/1,200	Current	✓	✓	✓	—	—	—	Adj.	—	✓	Recovery	✓	MSOP8
BD8158FVM	1	1,400	2.1 to 4.0	V _{IN} to 14	600/1,200	Current	✓	✓	✓	—	—	—	Adj.	—	✓	Recovery	✓	MSOP8
BD8306MUV	1	2,000	1.8 to 5.5	1.8 to 5.2	300 to 2,000	Voltage	✓	✓	—	—	✓	—	✓	—	✓	Latch	✓	VQFN016V3030
BD8311NUV	1	2,500	3.5 to 11	4.0 to 11	1,200	Voltage	✓	—	—	—	—	—	✓	—	✓	Latch	✓	VSON010V3030
BD8314NUV	1	2,500	3.0 to 12	4.0 to 12	1,200	Voltage	✓	—	—	—	—	—	✓	—	✓	Latch	✓	VSON010V3030

External Switch Switching Regulators

Buck Controllers																	
Part No.	Number of Channels	Input Voltage Maximum Rating (V)	Input Voltage (V)	Supply Voltage (V)	Output Voltage (V)	Switching Frequency (MHz)	Control Mode	Features							Package		
								Power Good	Enable	Externally Synchronizable	Adjustable Soft Start	Synchronous Rectifier	Light-Load Efficiency	Over-Current Protection		Thermal Protection	
BD9305AFVM	1	20.00	4.2 to 18	—	1.25 to V _{IN} *	0.1 to 0.8	Voltage	—	✓	—	—	—	—	—	SCP Latch	Recovery	MSOP8
BD95601MUV-LB	1	28.00	4.5 to 25	—	0.75 to 2.0	0.2 to 0.5	H ³ Reg	✓	✓	—	✓	✓	✓	—	Latch	Recovery	VQFN020V4040
BD63536FJ	1	32.00	3.0 to 30	—	1.25 to V _{IN} *	0.01 to 0.3	Voltage	—	—	—	—	—	—	—	Recovery	Recovery	SOP-J8
BD9845FV	1	36.00	3.6 to 35	—	1.0 to V _{IN} *	0.1 to 1.5	Voltage	—	✓	—	✓	—	—	—	Recovery	Recovery	SSOP-B14
BD9611MUV	1	60.00	10 to 56	—	(V _{IN} × 0.02) to (V _{IN} × 0.97) (V _{IN} × 0.02) ≥ 0.8*	0.05 to 0.5	Voltage	—	✓	✓	✓	✓	—	—	Recovery	Recovery	VQFN020V4040
BD9536FV	2	16.00	7.5 to 15	—	0.7 to 5.5	0.2 to 0.6	H ³ Reg	—	✓	—	✓	✓	—	—	Latch	Recovery	SSOP-B28
BD9535MUV	2	30.00	3.0 to 28	4.5 to 5.5	0.7 to 2.0	0.2 to 0.6	H ³ Reg	✓	✓	—	✓	✓	✓	—	Latch	Recovery	VQFN032V5050
BD95602MUV-LB	2	30.00	5.5 to 28	—	1.0 to 5.5	0.15 to 0.5	H ³ Reg	✓	✓	—	✓	✓	✓	—	Latch	Recovery	VQFN032V5050
BD9528AMUV	2	30.00	5.5 to 28	—	1.0 to 5.5	0.15 to 0.5	H ³ Reg	✓	✓	—	✓	✓	✓	—	Latch	Recovery	VQFN032V5050
BD9848FV	2	36.00	3.6 to 35	—	1.0 to V _{IN} *	0.1 to 1.5	Voltage	—	✓	—	✓	—	—	—	Recovery	Recovery	SSOP-B20

Boost and Buck-Boost Converters																		
Part No.	Number of Channels	Input Voltage Maximum Rating (V)	Input Voltage (V)	Output Voltage (V)	Switching Frequency (kHz)	Control Mode	Features							Package				
							Boost	Buck-Boost	Inverting	Buck	Enable	Externally Synchronizable	Adjustable Soft Start		Synchronous Rectifier	Over-Current Protection	Thermal Protection	
BD8303MUV	1	15	2.7 to 14	1.0 to 12	200 to 1,000	Voltage	—	✓	—	—	✓	—	—	—	✓	Latch	Recovery	VQFN016V3030
BD9306AFVM	1	20	4.2 to 18	V _{IN} to (V _{IN} /0.3)	100 to 800	Voltage	✓	—	—	—	✓	—	—	—	—	Latch	Recovery	MSOP8
BD9851EFV	2	20	4.0 to 18	1.0 or more*	10 to 300	Voltage	✓	—	✓	✓	—	—	—	✓	—	Latch	Recovery	HTSSOP-B20
BA9743AFV	2	36	3.6 to 35	2.505 or more*	10 to 800	Voltage	✓	—	✓	✓	—	—	—	✓	—	Latch	Recovery	SSOP-B16
BA9744FV	2	36	2.5 to 35	1.222 or more*	10 to 800	Voltage	✓	—	✓	✓	—	—	—	✓	—	Latch	Recovery	SSOP-B16
BA9741F	2	36	3.6 to 35	2.5 or more*	10 to 800	Voltage	✓	—	✓	✓	—	—	—	✓	—	Latch	Recovery	SOP16
BA9741FS	2	36	3.6 to 35	2.5 or more*	10 to 800	Voltage	✓	—	✓	✓	—	—	—	✓	—	Latch	Recovery	SSOP-A16

*:Restrictions depend on input/output voltage conditions.

For Automotive Switching Regulators

Switching Regulator(Integrated Switch) Single Output 1A Output												
Part No.	Input Voltage Maximum Rating (V)	Supply Voltage (V)	Output Current (A)	Output Voltage (V)	Output Voltage Accuracy (%)	Operating Temperature (°C)	Switching Frequency (MHz)	Frequency Accuracy (%)	Oscillation Circuit	Control Mode	Package	Automotive Grade AEC-Q100
BD90610EFJ-C	42	3.5 to 36	1.25	0.8 to V _{IN}	±2.0	-40 to +125	0.05 to 0.6	±10	Self-oscillation/External synchronization	PWM	HTSOP-J8	YES
Switching Regulators(Integrated Switch) Single Output 2A Output												
BD90620EFJ-C	42	3.5 to 36	2.5	0.8 to V _{IN}	±2.0	-40 to +125	0.05 to 0.6	±10	Self-oscillation/External synchronization	PWM	HTSOP-J8	YES
BD90620HFP-C	42	3.5 to 36	2.5	0.8 to V _{IN}	±2.0	-40 to +125	0.05 to 0.6	±10	Self-oscillation/External synchronization	PWM	HRP7	YES
BD9060F-C	36	5 to 35	2.0	0.8 to V _{IN}	±2.0	-40 to +125	0.05 to 0.5	±5	Self-oscillation/External synchronization	PWM	SOP8	YES
BD9060HFP-C	36	5 to 35	2.0	0.8 to V _{IN}	±2.0	-40 to +125	0.05 to 0.5	±5	Self-oscillation/External synchronization	PWM	HRP7	YES
New BD9G201EFJ-M	45	4.5 to 42	1.5	0.8 to V _{IN}	±2.0	-40 to +105	0.3	±10	Self-oscillation/External synchronization	PWM	HTSOP-J8ES	YES
Switching Regulators(Integrated Switch) Single Output 4A Output												
BD90640EFJ-C	42	3.5 to 36	4.0	0.8 to V _{IN}	±2.0	-40 to +125	0.05 to 0.6	±10	Self-oscillation/External synchronization	PWM	HTSOP-J8	YES
BD90640HFP-C	42	3.5 to 36	4.0	0.8 to V _{IN}	±2.0	-40 to +125	0.05 to 0.6	±10	Self-oscillation/External synchronization	PWM	HRP7	YES
New BD9G401EFJ-M	45	4.5 to 42	3.5	0.8 to V _{IN}	±2.0	-40 to +105	0.3	±10	Self-oscillation/External synchronization	PWM	HTSOP-J8ES	YES
Switching Regulators(Integrated Switch) Ultra Low Quiescent Current/Synchronous Rectification												
BD99010EFV-M	42	3.6 to 35	2.0	3.3	±2.0	-40 to +105	0.2 to 0.5	±20	Self-oscillation	Light load mode/PWM	HTSSOP-B24	YES
BD99011EFV-M	42	3.6 to 35	2.0	5.0	±2.0	-40 to +105	0.2 to 0.5	±20	Self-oscillation	Light load mode/PWM	HTSSOP-B24	YES
Switching Regulator(Integrated Switch) High Voltage/Synchronous Rectification												
New BD9V100MUF-C	70	16 to 60	1.0	0.8 to 5.5	±2.0	-40 to +125	1.9 to 2.3	±10	Self-oscillation	PWM	VQFN24FV4040	YES
Secondary Switching Regulator(Integrated Switch) Single Output 0.6A Output												
☆BD9S000NUX-C	7	2.7 to 5.5	0.6	0.8 to 5.0	±1.5	-40 to +125	2.2	±10	Self-oscillation	PWM	VSON008X2020	YES
Secondary Switching Regulator(Integrated Switch) Single Output 1A Output												
☆BD9S100NUX-C	7	2.7 to 5.5	1.0	0.8 to 5.0	±1.5	-40 to +125	2.2	±10	Self-oscillation	PWM	VSON008X2020	YES
Secondary Switching Regulator(Integrated Switch) Single Output 2A Output												
New BD9S200MUF-C	7	2.7 to 5.5	2.0	0.8 to 4.4	±1.5	-40 to +125	2.2	±10	Self-oscillation/External synchronization	Light load mode/PWM	VQFN16FV3030	YES
Secondary Switching Regulators(Integrated Switch) Single Output 3A Output												
New BD9S300MUF-C	7	2.7 to 5.5	3.0	0.8 to 4.4	±1.5	-40 to +125	2.2	±10	Self-oscillation/External synchronization	Light load mode/PWM	VQFN16FV3030	YES
New BD9S301MUF-C	7	2.7 to 5.5	3.0	0.8 to 4.4	±2.0	-40 to +125	1.0	±20	Self-oscillation	Light load mode/PWM	VQFN16FV3030	YES
Secondary Switching Regulator(Integrated Switch) Single Output 4A Output												
New BD9S400MUF-C	7	2.7 to 5.5	4.0	0.8 to 4.4	±1.5	-40 to +125	2.2	±10	Self-oscillation/External synchronization	Light load mode/PWM	VQFN16FV3030	YES
Switching Controllers(External Switch) Dual Output Buck/Boost Converters												
Part No.	Input Voltage Maximum Rating (V)	Supply Voltage (V)	Output Type	Output Voltage Accuracy (%)	Operating Temperature (°C)	Switching Frequency (MHz)	OverVoltage Protection is Detected	Package	Automotive Grade AEC-Q100			
BD9015KV-M	35	3.9 to 30	Push Pull	±1.5(-40 to +105°C)	-40 to +105	0.25 to 0.55	L-side FET OFF	VQFP48C	YES			
BD9016KV-M	35	3.9 to 30	Push Pull	±1.5(-40 to +105°C)	-40 to +105	0.25 to 0.55	L-side FET ON	VQFP48C	YES			
Switching Controller(External Switch) Single Output Buck/Boost Converters												
BD9035AEFV-C	35	3.8 to 30	Push Pull	±1.5(-40 to +125°C)	-40 to +125	0.1 to 0.6	Automatic switchover	HTSSOP-B24	YES			

☆ : Under Development

General-purpose ICs

Digital Controllers(Powervation) Series

Digital Controllers(Powervation) Series

Digital Controllers for Servers/Base Stations

Single-Phase Controllers ▶P.A53

Dual-Phase Controllers ▶P.A53

A

Power Management

Digital Controllers(Powervation) Series

Digital Controllers for Servers/Base Stations(Powervation)

Single-Phase Controllers																							
Part No.	Phase Count	Supply Voltage (V)	Interfaces				Auto-Tuning	Features											Fault Response				Package (mm)
			SMBus	VR12/12.5 SVID	VR13 SVID	3-Bit Parallel VID		Programmable fsw	Phase Add/ Drop	DSS®	Sensors & Precision Telemetry	Programmable Load-Line	Single Pin CONFIG™	ADDR	VSET/ VTRAC K/System Good	TSENSE Supported	OVP/ OCP	SCP/ OTP	LOS	Phase Loss			
PV3114	1	0.6 to 5.5	PMBUS™ Compliant	—	—	✓	Auto-Control®: Real-Time Adaptive Auto-Tuning	375kHz to 1MHz	—	—	Vout, Iout, Vin, Eout, Temperature, Duty Cycle, fsw	8 Tables	✓	—	Internal Die Sense & External	Restart/Latching	Restart/Latching	Retry or Disable	—	QFN28 (4×4)			
PV3101		0.6 to 5.5		—	—	—		375kHz to 1MHz	—	✓			✓	Restart/Latching		Retry	Retry	—	QFN32 (5×5)				
PV3102		0.6 to 5.5		—	—	—		375kHz to 1MHz	—	✓			✓	Restart/Latching		Retry	Retry	—	QFN28 (4×4)				
PV3104		0.6 to 1.52		✓	—	—		375kHz to 1MHz	—	—			—	—		Latch	Latch	—	—	QFN32 (5×5)			
PV3103		0.6 to 1.52		✓	—	—		375kHz to 1MHz	—	—			—	—		Latch	Latch	—	—	QFN28 (4×4)			
PV3105		0.6 to 5.5		—	—	—		375kHz to 1.25MHz	—	✓			✓	Restart/Latching		Restart/Latching	—	—	—	QFN28 (4×4)			
New PV4110		0.25 to 3.04		✓	✓	—		375kHz to 1MHz	Automatic	—			✓	23 Tables		—	—	Restart/Latching	Restart/Latching	—	—	—	—
Dual-Phase Controllers																							
PV3204	2	0.6 to 5.5	PMBUS™ Compliant	—	—	✓	Auto-Control®: Real-Time Adaptive Auto-Tuning	375kHz to 1MHz	Automatic	—	Vout, Iout, Vin, Eout, Temperature, Duty Cycle, fsw	8 Tables	✓	—	Internal Die Sense & External	Restart/Latching	Restart/Latching	Retry or Disable	Restart	QFN32 (5×5)			
PV3012		0.6 to 5.5		—	—	—		375kHz to 1MHz	Automatic	✓			✓	Restart/Latching		Retry	Retry	—	QFN32 (5×5)				
PV3201		0.6 to 1.52		✓	—	—		375kHz to 1MHz	SVID	—			—	Latch		Latch	—	—	QFN32 (5×5)				
PV3203		0.6 to 5.5		—	—	—		375kHz to 1.25MHz	Automatic	✓			✓	Restart/Latching		Restart/Latching	Retry	Restart	QFN32 (5×5)				
PV3205		0.6 to 5.5		—	—	—		375kHz to 1.25MHz	Automatic	✓			✓	Restart/Latching		Restart/Latching	Retry	Restart	QFN32 (5×5)				
PV3202		0.6 to 1.52		✓	—	—		375kHz to 1MHz	Automatic/SVID	—			—	Latch		Latch	—	—	QFN32 (5×5)				
PV3207		0.6 to 5.5		—	—	—		375kHz to 1MHz	Automatic	✓			✓	Restart/Latching		Latch	Retry	—	QFN32 (5×5)				
New PV4210		0.25 to 3.04		✓	✓	—		375kHz to 1MHz	Automatic	—			✓	23 Tables		—	—	Restart/Latching	Restart/Latching	—	—	—	—

*Auto-Control® is a registered trademark of Powervation Limited. DSS® is a registered trademark of Powervation Limited.

General-purpose ICs

Switching Regulators (System Power Supplies)

Switching Regulators(System Power Supplies)

**System Power Supply ICs
for Car Audio**
**System Power Supply ICs for
Car Audio Systems ▶ P.A55**
**System Power Supply ICs
for LCD Panels**
**Single-Channel Source Voltage Output Power
Supply IC with Gamma Buffer Amp. ▶ P.A55**
**Multi-Channel System Power Supply ICs
for Small- to Midium-Sized Panels ▶ P.A55**
**Multi-Channel System Power Supply ICs
for Large Panels ▶ P.A55**
**Automotive Panel Power
Management ICs ▶ P.A55**
**Programmable
Gamma-Voltage Generator/
Gamma Buffer Amp.**
**High-precision Gamma Correction ICs
with Built-in DAC ▶ P.A55**
**High-precision Gamma Correction IC
with Built-in DAC for Automotive Panels ▶ P.A55**
**System Power Supply ICs
for Mobile Phones**
**Multifunction
System Power Supply ICs ▶ P.A56**
**System Power Supply ICs
for DSC/DVCs**
**System Switching Regulator ICs
with Built-in FET(5V) ▶ P.A56**
**System Switching Regulator ICs
for Digital Video Cameras/for DSLRs ▶ P.A56**
Strobe Charge Control ICs ▶ P.A56
Backup Battery Switching ICs ▶ P.A56
**System Power Supply ICs
for Automotive**
3ch System Power Supply ICs ▶ P.A57
2ch System Power Supply ICs ▶ P.A57
**System Power Supply ICs
for Industrial/
Consumer Applications**
**Power Management IC(PMIC) for Intel®
Atom™ E3800 series Platform ▶ P.A57**
**Power Management IC for NXP i.MX
series Applications Processors ▶ P.A57**

Switching Regulators(System Power Supplies)

System Power Supply ICs for Car Audio

System Power Supply ICs for Car Audio Systems											
Part No.	Supply Voltage (V)	Function		Reference Voltage (V)	Output Current (A)	Protection Circuit		Input I/F	Package	Automotive Grade AEC-Q100	
						Over Current	Temperature				
BD49101AEFS-M / BD49101ARFS-M	5.5 to 25.0	Buck DC/DC1	Controller	0.8	—	Current Limit with Short Current Protection Circuit	Foldback	✓	I ² C	HTSSOP-A44 / HTSSOP-A44R	YES
		Buck DC/DC2	Low Power Standby REG	0.8	1.0						
		REG1	Secondary	0.6	0.5						
		REG2	—	0.8	0.1						
		REG3	Secondary	0.8	0.3						
		REG4	Secondary, Voltage Calibration	0.8	1.5 (Variable)						
		REG5	—	0.8	0.1						
		High Side Switch	—	—	0.5						
+B Detection Circuit	Over/Under Current Detection	—	—	—	—						

System Power Supply ICs for LCD Panels

Single-Channel Source Voltage Output Power Supply IC with Gamma Buffer Amp.							
Part No.	Supply Voltage (V)	Operating Temperature (°C)	Operating Frequency (MHz)	Output for Source Voltage (V)	V COM (ch)	Buffer for Gamma (ch)	Package
BD8157EFV	2.1 to 4.0	-40 to +125	0.6/1.2	up to 14	1	4	HTSSOP-B20

Multi-Channel System Power Supply ICs for Small- to Midium-Sized Panels									
Part No.	Supply Voltage (V)	Operating Temperature (°C)	Operating Frequency (MHz)	Output for Source Voltage (V)	Output for Logic Voltage (V)	Output for Gate Voltage (V)	Start up Sequence Circuit	V COM (ch)	Package
BD8153EFV	2.1 to 6.0	-40 to +125	1.1	up to 18.0	3.3	Variable	✓	—	HTSSOP-B24
BD8163EFV	2.1 to 6.0	-40 to +125	1.1	up to 18.0	2.5	Variable	✓	—	HTSSOP-B24
BD8179MUV	2.6 to 5.5	-40 to +85	1.2	up to 19.0	—	Variable	✓	1 (Buffer 4ch)	VQFN032V5050
BD9862MUV	1.8 to 5.5	-40 to +85	0.7 to 1.4	up to 15.0	—	Variable	✓	—	VQFN024V4040
BM81028AMWV	2.5 to 5.5	-40 to +85	0.6/1.2	8.0 to 14.5 0.1V step	1.1 to 1.3 50mV step 1.7 to 1.9/2.4 to 2.6 50mV step	13 to 26 0.2V step/ -4 to -9.3 0.1V step	✓	1	UQFN28V4040P

Multi-Channel System Power Supply ICs for Large Panels										
Part No.	Supply Voltage (V)	Operating Temperature (°C)	Operating Frequency (MHz)	Output for Source Voltage (V)	Output for Logic Voltage1 (V)	Output for Logic Voltage2 (V)	Output for Gate Voltage (V)	Start up Sequence Circuit	V COM (ch)	Package
BD8166EFV	6.0 to 18.0	-40 to +85	0.5	up to 18.0	Variable	—	Variable	✓	1	HTSSOP-B40
BD8160AEFV	8.0 to 18.0	-40 to +85	0.5/0.75	up to 18.0	Variable	—	Variable	✓	—	HTSSOP-B28
BD8165MUV	4.2 to 14.0	-40 to +105	0.65	up to 18.0	Variable	Variable	Variable	✓	1	VQFN048V7070
BD8162AEKV	4.2 to 14.0	-40 to +105	0.2 to 0.8	up to 18.0	Variable	Variable	Variable	✓	1 (Buffer 4ch)	HTQFP64V
☆ BM81100MUW	7.6 to 14.0	-40 to +85	0.75	up to 19.8	Variable	—	Variable	✓	1	VQFN40W6060A
BM81110MUW	8.6 to 14.7	-40 to +85	0.75/1.0	up to 19.8	Variable	Variable	Variable	✓	—	VQFN40W6060A
BM81004MUV	8.6 to 14.0	-40 to +105	0.75/1.0	up to 18.0	Variable	Variable	Variable	✓	1	VQFN48V7070A

Automotive Panel Power Management ICs											
Part No.	Supply Voltage (V)	Operating Temperature (°C)	Operating Frequency (MHz)	Output for Source Voltage1 (V)	Output for Source Voltage2 (V)	Output for Logic Voltage (V)	Output for Gate Voltage (V)	Start up Sequence Circuit	V COM (ch)	Package	Automotive Grade AEC-Q100
BD81842MUV-M	2.0 to 5.5	-40 to +105	2.1	up to 18.0	—	—	Variable	✓	1	VQFN24SV4040	YES
BM81810MUV-M	2.6 to 5.5	-40 to +105	0.525/1.05/2.1	5.0 to 17.0 0.1V step	—	0.9 to 3.4 50mV step	8.0 to 35.0 0.2V step/ -14.0 to -4.0 0.1V step	✓	1	VQFN32SV5050	YES
BD81870EFV-M	2.5 to 5.5	-40 to +105	2.1	up to 18.0	V _{DD} -13.0 to -1.0	—	—	✓	—	HTSSOP-B20	YES

☆ : Under Development

Programmable Gamma-Voltage Generator/Gamma Buffer Amp.

High-precision Gamma Correction ICs with Built-in DAC										
Part No.	Supply Voltage(V)		Operating Temperature (°C)	Clock Frequency (MHz)	DAC (bit)	Serial I/F	Auto Data Read	V COM (ch)	Buffer for Gamma (ch)	Package
	Gamma Collection Input	Logic								
BD8132FV	6 to 18	2.3 to 4	-30 to +85	5.0	10	3-wire	✓	1	18	SSOP-B40
BD8139AEFV	6 to 18	2.3 to 4	-30 to +85	0.4	10	I ² C BUS	✓	1	10	HTSSOP-B40
BD8143MUV	8 to 18	2.3 to 5.5	-40 to +105	2.0	10	3-wire	—	—	12	VQFN032V5050
BD81010MUV	8 to 18	2.1 to 3.6	-40 to +85	0.4	10	I ² C BUS	—	1	12	VQFN032V5050
BD8149MUV	10 to 18	2.1 to 3.6	-25 to +85	0.4	10	I ² C BUS	✓	—	12	VQFN032V5050
BD81026MUV	8 to 18	2.1 to 3.6	-25 to +85	0.4	10	I ² C BUS	—	—	12	VQFN024V4040

High-precision Gamma Correction IC with Built-in DAC for Automotive Panels											
Part No.	Supply Voltage(V)		Operating Temperature (°C)	Clock Frequency (MHz)	DAC (bit)	Serial I/F	Auto Data Read	V COM (ch)	Buffer for Gamma (ch)	Package	Automotive Grade AEC-Q100
	Gamma Collection Input	Logic									
BD81849MUV-C	10 to 18	2.1 to 3.6	-40 to +105	0.4	10	I ² C BUS	✓	—	12	VQFN32SV5050	YES

System Power Supply ICs for Mobile Phones
Multifunction System Power Supply ICs

Part No.	Supply Voltage (V)	Item	DC/DC		LDO						Input I/F	Protection Circuit			Package (mm)
			DC/DC1	DC/DC2	LDO1	LDO2	LDO3	LDO4	LDO5	LDO6		Over Current	Temperature	Low Voltage	
BH6173GUL	2.2 to 5.2	Output Voltage(V)	0.8 to 2.4	—	1.0 to 3.3	1.0 to 3.3	1.2 to 3.3	—	—	—	i ² C	LDO1 to 3 is fold back DC/DC is dropping type	✓	✓	VCSP50L2 (2.05×2.05) H=0.55 Max.
		Output Current(mA)	500	—	300	300	300	—	—	—					
		Ripple Rejection(dB)(at 120Hz)	—	—	60	60	60	—	—	—					
BH6172GU	2.2 to 5.5	Output Voltage(V)	0.8 to 2.4	—	1.0 to 3.3	1.0 to 3.3	1.2 to 3.3	1.2 to 3.3	1.2 to 3.3	—	i ² C/Parallel	LDO1 to 5 is fold back DC/DC is dropping type	✓	✓	VCSP85H2 (2.6×2.6) H=1.0 Max.
		Output Current(mA)	500	—	150	150	300	300	150	—					
		Ripple Rejection(dB)(at 120Hz)	—	—	60	60	60	60	60	—					
BH6174GUL	2.6 to 5.5	Output Voltage(V)	0.8 to 2.4	0.8 to 2.4	1.0 to 3.3	1.0 to 3.3	1.2 to 3.3	1.2 to 3.3	1.2 to 3.3	—	i ² C/Parallel	LDO1 to 5 is fold back DC/DC is dropping type	✓	✓	VCSP50L2 (2.6×2.6) H=0.55 Max.
		Output Current(mA)	600	600	300	300	300	300	300	—					
		Ripple Rejection(dB)(at 120Hz)	—	—	60	60	60	60	60	—					
BH6178GUL	2.7 to 4.5	Output Voltage(V)	1.8	1.235	1.8	1.8	1.215	1.2	2.7	—	Parallel	LDO1 to 5 is fold back DC/DC is dropping type	✓	✓	VCSP50L2 (2.6×2.6) H=0.55 Max.
		Output Current(mA)	400	650	50	50	50	50	50	—					
		Ripple Rejection(dB)(at 120Hz)	—	—	60	60	60	60	60	—					
BH6176GU	2.2 to 5.5	Output Voltage(V)	0.8 to 2.35	—	1.0 to 3.3	1.0 to 3.3	1.2 to 3.3	1.2 to 3.3	1.2 to 3.3	1.2 to 3.3	i ² C/Parallel	LDO1 to 6 is fold back DC/DC is dropping type	✓	✓	VCSP85H2 (2.6×2.6) H=1.0 Max.
		Output Current(mA)	500	—	150	150	300	300	150	300					
		Ripple Rejection(dB)(at 120Hz)	—	—	60	60	60	60	60	60					
BH6179GU	2.2 to 5.5	Output Voltage(V)	0.8 to 2.35	—	1.0 to 3.3	1.0 to 3.3	1.2 to 3.3	1.2 to 3.3	1.2 to 3.3	1.2 to 3.3	i ² C/Parallel	LDO1 to 6 is fold back DC/DC is dropping type	✓	✓	VCSP85H2 (2.6×2.6) H=1.0 Max.
		Output Current(mA)	600	—	150	150	300	300	150	300					
		Ripple Rejection(dB)(at 120Hz)	—	—	50	50	50	50	50	50					

Part No.	Supply Voltage (V)	Item	DC/DC Output			LDO Output										Buffer for TCXO	Lithium Ion Charging Control	USB Transceiver	Protection Circuities	Protection Circuit			Package	
			DC/DC1	DC/DC2	DC/DC6	LDO1	LDO1-2	LDO2	LDO3	LDO4-5	LDO6-7	LDO8	LDO9	LDO10	Over Current					Temperature	Low Voltage			
BH6062GW	2.9 to 4.6	Output Voltage(V)	1.175	1.825	1.920	2.8	—	1.175	1.835	—	—	—	—	—	—	—	—	—	—	—	LDO is fold back DC/DC is dropping type	✓	✓	UCSP75M3
		Output Current(mA)	900	800	400	40	—	50	30	—	—	—	—	—	—	—	—	—	—	—				

Part No.	Supply Voltage (V)	Item	DC/DC Output					LDO Output										Buffer for TCXO	SIM I/F	Protection Circuities	Protection Circuit			Package		
			SWREG1	SWREG2	SWREG3	SWREG4	SWREG5	LDO1	LDO2	LDO3	LDO4	LDO5	LDO6	LDO7	LDO8	LDO9	LDO10				LDO11	LDO12	Over Current		Temperature	Low Voltage
BD71801AGWL	2.6 to 5.5	Output Voltage(V)	1.1	1.8	1.2	1.4	3.2	2.6/1.8	3.3	1.8	2.8	1.2	2.8	2.8	2.5	2.8	2.8	1.2	1.2	—	—	—	LDO is fold back DC/DC is dropping type	✓	✓	UCSP50L3C
		Output Current(mA)	1,000	500	1,000	500	1,400	300	50	50	300	150	150	150	150	150	150	150	150	150	150	150				

LDOs, detectors and charge control in a single chip

System Power Supply ICs for DSC/DVCs
System Switching Regulator ICs with Built-in FET(5V)

Part No.	Ch	Operating Frequency (MHz)	Supply Voltage (V)	Reference Voltage (V)	Reference Voltage Precision (%)	Topology					Built-in FET (ch)	Synchronous Rectifier (ch)	Load Switch (ch)	Package (mm)
						Step up (ch)	Step down (ch)	Step up/down (ch)	Inverting (ch)	Buck-Boost (ch)				
BD9639MWW	6	0.5 to 2.0	2.5 to 5.5	0.4	±2.5	2	2	—	—	2	6	5	1	UQFN056V7070
BD9361GUL	6	2.0/1.0	2.5 to 5.5	0.8	±1.25	2	3	—	—	1	6	5	—	VCSP50L3 (3.14×3.14) H=0.55 Max.
BD9355MWW	7	2.0/1.0	1.5 to 5.5	0.8	±1.25	3	2	—	1	1	7	3	1	UQFN036V5050
				1.0	±1.0									
BD9757MWW	8	1.2	1.5 to 5.5	1.0	±1.0	3	4	—	1	—	7	5	2	UQFN044V6060
				0.8	±1.25									
BD9634GU	7	0.5 to 1.5	2.5 to 5.5	0.8	±2.5	3	1	1	1	1	5	3	1	VCSP85H4 (4.26×4.26) H=1.0 Max.

System Switching Regulator ICs for Digital Video Cameras/for DSLRs

Part No.	Ch	Operating Frequency (MHz)	Supply Voltage (V)	Reference Voltage (V)	Reference Voltage Precision (%)	Step up (ch)	Step down (ch)	Buck-Boost (ch)	Inverting/Stepdown (ch)	Built-in FET (ch)	Synchronous Rectifier (ch)	Load Switch (ch)	Package (mm)
BD9866GUL	4	0.6 to 1.5	4 to 14	0.6	±1.66	—	3	1	—	4	4	—	VCSP50L3 (3.75×3.75) H=0.55 Max.
				0.8	±1.25								
BD8355MWW	7	0.5 to 1.8	4 to 10	0.8	±1.25	1	6	—	—	7	6	—	UQFN056V7070
				1.0	±1.0								

Strobe Charge Control ICs

Part No.	Supply Voltage (V _{CC})(V)	Peak Current (A)	Full Charge Detection Voltage(V)	100nsec pulse AC Full Charge Detection Voltage(V)	Full Terminal Output	Power Tr Saturation Voltage I _{sw} =1A(V)	IGBTOUTN (mA)	IGBTOUTP (mA)	Package
BD4233NUX	2.5 to 5.5	0.5 to 2.0	1±1.1%	1.0-1.1% to ±1.6%	Nch Open drain	0.4	60	140	VSON010X3020
BD4234NUX	2.5 to 5.5	0.5 to 2.0	1±1.1%	1.0-1.1% to ±1.6%	Nch Open drain	0.4	30	140	VSON010X3020

Backup Battery Switching ICs

Part No.	Input Voltage Range(V)		Output Voltage(V)		Input Detection Voltage(V)		Output Detection Voltage(V)		Switching Voltage(V)	Unreg Reset Voltage(V)		Package
	V _{IN}	V _{RO}	V _{OUT}	V _{OUT}	-V _{det1}	+V _{det1}	-V _{det2}	+V _{det2}	V _{sw1}	-V _{det3} (VDETSEL=L)	-V _{det4} (VDETSEL=H)	
BD7212MUV	3.50 to 6.00	3.2	3.2	3.2	3.5	3.6	2.10	2.23	3.06	1.5	2.5	VQFN016V3030
BD7213MUV	3.50 to 8.00	3.2	3.2	3.2	3.3	3.4	2.05	2.14	2.89	1.5	2.5	VQFN016V3030
BD7214MUV	3.50 to 8.00	3.2	3.2	3.2	3.3	3.4	2.05	2.14	2.89	—	—	VQFN016V3030

System Power Supply ICs for Automotive

3ch System Power Supply ICs														
Part No.	Power Supply Voltage (V)	Operating Frequency (kHz)	Operating Temperature (°C)	Sequence	Initial Accuracy	Output		Function				Package	Automotive Grade AEC-Q100	
						Channel	Vout/Max. Iout	Over Current Protection	TSD	Under/Over Voltage Detection	Reset			WDT
New BD39000EKV-C	4 to 30 (Rating 40V)	200 to 550	-40 to +125	✓	±2	CH1 (DC/DC)	Buck-Boost DC/DC Controller (Vout/Iout variable)	✓	✓	✓	—	WINDOW WDT	HTQFP48V	YES
						CH2 (DC/DC)	Synchronous Buck DC/DC Converter (1.23V, 0.9A)							
						CH3 (LDO)	LDO(5V, 0.6A)							
BD39001EKV-C	4 to 30 (Rating 40V)	200 to 550	-40 to +125	✓	±2	CH1 (DC/DC)	Buck-Boost DC/DC Controller (Vout/Iout variable)	✓	✓	✓	—	WINDOW WDT	HTQFP48V	YES
						CH2 (DC/DC)	Synchronous Buck DC/DC Converter (3.3V, 0.9A)							
						CH3 (LDO)	LDO(5V, 0.6A)							

2ch System Power Supply ICs																					
Part No.	Supply Voltage(V)	Item	DC/DC Output	SW	LDO output	I/F	Protection Circuit	Package (mm)													
									DC/DC1 V1P0A	DC/DC2 V1P0S	DC/DC3 V1P8A	DC/DC4 VDDQ	DC/DC5 V1P05S	DC/DC6 VCC	DC/DC7 VNN	V1P8S	LDO1 VRTC	LDO2 V3P3A	LDO3 V3P3S	LDO4 V1P24A	LDO5 VSDIO
BD39002EFV-C	4 to 30 (Rating 40V)	Output Voltage(V)	1.0	1.0	1.8	1.2 to 1.6	1.05	0.5 to 1.2	0.5 to 1.2	1.8	3.3	3.3	3.3	1.24	1.8 or 3.3	1.24	VDDQ/2	1.35	IMVP7	UVLO, TSD, SCP, OVP	UQFN88MV0100 (10×10×1.0)
			Output Current(mA)	700	2,600	1,800	4,500	1,300	13,000	13,000	800	120	100	500	50	20	50	530			
BD39012EFV-C	4 to 36 (Rating 45V)	Output Voltage(V)	1.0	1.0	1.8	1.2 to 1.6	1.05	0.5 to 1.2	0.5 to 1.2	1.8	3.3	3.3	3.3	1.24	1.8 or 3.3	1.24	VDDQ/2	1.35	IMVP7	UVLO, TSD, SCP, OVP	UQFN88MV0100 (10×10×1.0)
			Output Current(mA)	700	2,600	1,800	4,500	1,300	13,000	13,000	800	120	100	500	50	20	50	530			

System Power Supply ICs for Industrial/Consumer Applications

Power Management IC(PMIC) for Intel® Atom™ E3800 series Platform																					
Part No.	Supply Voltage(V)	Item	DC/DC Output							SW	LDO output								I/F	Protection Circuit	Package (mm)
			DC/DC1 V1P0A	DC/DC2 V1P0S	DC/DC3 V1P8A	DC/DC4 VDDQ	DC/DC5 V1P05S	DC/DC6 VCC	DC/DC7 VNN		V1P8S	LDO1 VRTC	LDO2 V3P3A	LDO3 V3P3S	LDO4 V1P24A	LDO5 VSDIO	LDO6 V1P24S	LDO7 VTT			
BD9596BMWV	3.5 to 5.5	Output Voltage(V)	1.0	1.0	1.8	1.2 to 1.6	1.05	0.5 to 1.2	0.5 to 1.2	1.8	3.3	3.3	3.3	1.24	1.8 or 3.3	1.24	VDDQ/2	1.35	IMVP7	UVLO, TSD, SCP, OVP	UQFN88MV0100 (10×10×1.0)
		Output Current(mA)	700	2,600	1,800	4,500	1,300	13,000	13,000	800	120	100	500	50	20	50	530	500			

Power Management ICs for NXP i.MX series Applications Processors																						
Part No.	Correspondance	Item	DC/DC Output					LDO Output								White LED Driver	Lithium Charging Control	Coulomb Counter	RTC	GPO (ch)	I ² C I/F	Package
			BUCK1	BUCK2	BUCK3	BUCK4	BUCK5	LD01	LD02	LD03	LD04	LD05	LD05NS	LD0LPSR	LD0DREF							
BD71805MWV	i.MX 6 SoloLite	Output Voltage(V)	0.8 to 2.0	0.8 to 2.0	2.6 to 3.35	1.0 to 2.7	—	0.8 to 3.3	0.8 to 3.3	0.8 to 3.3	—	—	3	—	0.5× DVREFIN	—	✓	✓	✓	3	✓	UQFN064MV8080
		Output Current(mA)	2,000	1,000	1,000	1,000	—	300	300	300	—	—	25	—	10	—	—	—	—	—	—	—
BD71815AGW	i.MX 7 Dual i.MX 7 Solo	Output Voltage(V)	0.8 to 2.0	0.8 to 2.0	1.2 to 2.7	1.1 to 1.85	1.8 to 3.3	0.8 to 3.3	0.8 to 3.3	0.8 to 3.3	0.8 to 3.3	0.8 to 3.3	3	1.8	0.5× DVREFIN	✓	✓	✓	✓	1	✓	UCSP55M4C
		Output Current(mA)	800	1,000	500	1,000	1,000	100	100	50	400	250	25	100	10	—	—	—	—	—	—	—

Isolated/No Isolated Power Supply

AC/DC Converter ICs

Non-isolated AC/DC Converter ICs(PWM Driver Built-in MOSFET and Sense Resistor)									
Part No.	Output Voltage (V)	MOSFET Tolerate (V)	Control Method	Switching Frequency(kHz)	ON Resistance (Ω)	OCP Current (A)	Frequency Reduction	Max. Duty (%)	Package
New BM2P109TF	10.0	650	PWM	100	9.0	0.45	—	75	SOP8
New BM2P129TF	12.0	650	PWM	100	9.0	0.45	—	75	SOP8
New BM2P135TF	13.0	650	PWM	100	4.5	0.45	—	75	SOP8
New BM2P137TKF	13.0	800	PWM	100	7.5	0.45	—	75	SOP8
New BM2P139TF	13.0	650	PWM	100	9.0	0.45	—	75	SOP8
New BM2P159PF	14.2	650	PWM	100	9.0	0.30	—	75	SOP8
New BM2P159T1F	15.0	650	PWM	100	9.0	0.45	—	75	SOP8
New BM2P161W	16.8	650	PWM	65	1.9	1.46	✓	40	DIP7K
New BM2P163W	16.8	650	PWM	65	3.0	1.46	✓	40	DIP7K
New BM2P249Q	24.8	650	PWM	65	9.0	0.80	✓	40	DIP7K
New BM2P249TF	24.8	650	PWM	100	9.0	0.45	—	75	SOP8

AC/DC Converter ICs(PWM Driver Built-in MOSFET)									
Part No.	Supply Voltage (V)	MOSFET Tolerate (V)	Control Method	Switching Frequency(kHz)	ON Resistance (Ω)	Peak Current (A)	Brown Out	V _{CC} OVP	Package
New BM2P0391	8.9 to 26.0	650	PWM	100	4.0	5.2	✓(adjustable)	Self-restart	DIP7K
New BM2P095F	8.9 to 26.0	650	PWM	65	8.5	1.3	—	Latch	SOP8
New BM2PA96F	8.9 to 26.0	650	PWM	65	8.5	1.3	—	Self-restart	SOP8
New BM2P015	8.9 to 26.0	650	PWM	65	1.4	10.4	—	Latch	DIP7K
New BM2P016	8.9 to 26.0	650	PWM	65	1.4	10.4	—	Self-restart	DIP7K
New BM2P016T	8.9 to 26.0	650	PWM	65	1.4	10.4	—	Self-restart	TO220
BM2P011	8.9 to 26.0	650	PWM	65	1.4	10.4	✓(adjustable)	Latch	DIP7K
BM2P012	8.9 to 26.0	650	PWM	65	1.4	10.4	✓(adjustable)	Self-restart	DIP7K
BM2P013	8.9 to 26.0	650	PWM	65	1.4	10.4	—	Latch	DIP7K
BM2P014	8.9 to 26.0	650	PWM	65	1.4	10.4	—	Self-restart	DIP7K
BM2P031	8.9 to 26.0	650	PWM	65	2.4	5.2	✓(adjustable)	Latch	DIP7K
BM2P032	8.9 to 26.0	650	PWM	65	2.4	5.2	✓(adjustable)	Self-restart	DIP7K
BM2P033	8.9 to 26.0	650	PWM	65	2.4	5.2	—	Latch	DIP7K
BM2P034	8.9 to 26.0	650	PWM	65	2.4	5.2	—	Self-restart	DIP7K
BM2P051	8.9 to 26.0	650	PWM	65	4.0	2.6	✓(adjustable)	Latch	DIP7K
BM2P051F	8.9 to 26.0	650	PWM	65	4.0	2.6	✓(adjustable)	Latch	SOP8
BM2P052	8.9 to 26.0	650	PWM	65	4.0	2.6	✓(adjustable)	Self-restart	DIP7K
BM2P052F	8.9 to 26.0	650	PWM	65	4.0	2.6	✓(adjustable)	Self-restart	SOP8
BM2P053	8.9 to 26.0	650	PWM	65	4.0	2.6	—	Latch	DIP7K
BM2P053F	8.9 to 26.0	650	PWM	65	4.0	2.6	—	Latch	SOP8
BM2P054	8.9 to 26.0	650	PWM	65	4.0	2.6	—	Self-restart	DIP7K
BM2P054F	8.9 to 26.0	650	PWM	65	4.0	2.6	—	Self-restart	SOP8
BM2P091	8.9 to 26.0	650	PWM	65	8.5	1.3	✓(adjustable)	Latch	DIP7K
BM2P091F	8.9 to 26.0	650	PWM	65	8.5	1.3	✓(adjustable)	Latch	SOP8
BM2P092	8.9 to 26.0	650	PWM	65	8.5	1.3	✓(adjustable)	Self-restart	DIP7K
BM2P092F	8.9 to 26.0	650	PWM	65	8.5	1.3	✓(adjustable)	Self-restart	SOP8
BM2P093	8.9 to 26.0	650	PWM	65	8.5	1.3	—	Latch	DIP7K
BM2P093F	8.9 to 26.0	650	PWM	65	8.5	1.3	—	Latch	SOP8
BM2P094	8.9 to 26.0	650	PWM	65	8.5	1.3	—	Self-restart	DIP7K
BM2P094F	8.9 to 26.0	650	PWM	65	8.5	1.3	—	Self-restart	SOP8
BM2P074KF	10.2 to 26.0	800	PWM	65	6.7	2.0	—	Self-restart	SOP8
AC/DC Converter ICs(PWM Driver Built-in MOSFET and Sense Resistor)									
Part No.	Supply Voltage (V)	MOSFET Tolerate	Control Method	Switching Frequency(kHz)	ON Resistance (Ω)	OCP Current (A)	Brown Out (V)	V _{CC} OVP	Package
New BM2P01A	11.9 to 26.0	650	PWM	100	2.0	0.43	100	Latch	DIP8
New BM2P01B	11.9 to 26.0	650	PWM	100	2.0	0.54	100	Latch	DIP8
AC/DC Converter ICs(PWM Controller)									
Part No.	Supply Voltage (V)	Control Method	START-UP Circuit	Switching Frequency(kHz)	AC line Voltage Correction	V _{CC} Recharge	Brown Out	V _{CC} OVP	Package
BM1P061FJ	8.9 to 26.0	PWM	✓	65	✓	✓	✓(adjustable)	Self-restart	SOP-J8
BM1P062FJ	8.9 to 26.0	PWM	✓	65	✓	✓	✓(adjustable)	Latch	SOP-J8
BM1P065FJ	8.9 to 26.0	PWM	✓	65	✓	—	✓(adjustable)	Self-restart	SOP-J8
BM1P066FJ	8.9 to 26.0	PWM	✓	65	✓	—	✓(adjustable)	Latch	SOP-J8
BM1P067FJ	8.9 to 26.0	PWM	✓	65	✓	—	—	Self-restart	SOP-J8
BM1P068FJ	8.9 to 26.0	PWM	✓	65	✓	—	—	Latch	SOP-J8
BM1P101FJ	8.9 to 26.0	PWM	✓	100	✓	✓	✓(adjustable)	Self-restart	SOP-J8
BM1P102FJ	8.9 to 26.0	PWM	✓	100	✓	✓	✓(adjustable)	Latch	SOP-J8
BM1P105FJ	8.9 to 26.0	PWM	✓	100	✓	—	✓(adjustable)	Self-restart	SOP-J8
BM1P107FJ	8.9 to 26.0	PWM	✓	100	✓	—	—	Self-restart	SOP-J8
BD7672BG	8.5 to 25.0	PWM	—	65	—	—	—	Latch	SSOP6
BD7673AG	8.5 to 25.0	PWM	—	65	—	—	—	Latch	SSOP6
BD7679G	8.5 to 25.0	PWM	—	65	—	—	—	Self-restart	SSOP6
BD7678FJ	8.5 to 25.5	PWM	—	65	✓	—	✓(adjustable)	Latch	SOP-J8
AC/DC Converter ICs(Quasi-Resonant Controller)									
Paart No.	Supply Voltage (V)	Control Method	START-UP Circuit	Maximum Frequency(kHz)	AC line Voltage Correction	FBOLP	V _{CC} OVP	ZT OVP	Package
BM1Q002FJ	8.9 to 26.0	QR	✓	120	✓	Self-restart	Latch	Latch	SOP-J8
New BM1Q021FJ	8.9 to 26.0	QR	✓	120	✓	Self-restart	Self-restart	Self-restart	SOP-J8
New BM1Q041FJ	8.9 to 26.0	QR	✓	120	✓	Self-restart	Self-restart	none	SOP-J8
AC/DC Converter ICs(PFC, PFC+Quasi-Resonant Controller)									
Part No.	Supply Voltage (V)	Control Method	START-UP Circuit	X-cap Discharge	QR Maximum Frequency(kHz)	PFC Maximum Frequency(kHz)	PFC Output Voltage Conversion	V _{CC} OVP/ZT OVP	Package
New BD7690FJ	10.0 to 26.0	PFC	—	—	—	220	—	—	SOP-J8
New BD7691FJ	10.0 to 26.0	PFC	—	—	—	220	—	—	SOP-J8
BM1050AF	8.9 to 26.0	PFC+QR	✓	—	120	65	—	Selectable Externally	SOP24
BM1051F	8.9 to 26.0	PFC+QR	✓	—	120	65	—	Selectable Externally	SOP24
BM1C101F	8.9 to 26.0	PFC+QR	✓	✓	120	400	✓	✓	SOP18
BM1C102F	8.9 to 26.0	PFC+QR	✓	✓	120	400	—	✓	SOP18

AC/DC Converter ICs(For SiC MOSFET Driving)									
Part No.	Supply Voltage (V)	Control Method	MOSFET	MOSFET Performance	Maximum Frequency(kHz)	FBOLP	Brown Out	V _{CC} OVP	Package
BD7682FJ-LB	15 to 27.5	QR	External	—	120	Self-restart	✓ (adjustable)	Latch	SOP-J8
BD7683FJ-LB	15 to 27.5	QR	External	—	120	Latch	✓ (adjustable)	Latch	SOP-J8
BD7684FJ-LB	15 to 27.5	QR	External	—	120	Self-restart	✓ (adjustable)	Self-restart	SOP-J8
BD7685FJ-LB	15 to 27.5	QR	External	—	120	Latch	✓ (adjustable)	Self-restart	SOP-J8

AC/DC Converter ICs(Secondary Side Synchronous Rectification with Shunt Regulator)									
Part No.	Supply Voltage (V)	Control Method	Shunt Regulator Accuracy(%)	Drain Terminal Maximum Voltage(V)	Compulsion OFF Time(μs)	V _{CC} OVP	Auto Sleep Function	CCM Mode	Package
New BM1R00146F	2.7 to 32.0	SR	± 0.5	120	1.3	Self-restart	✓	✓	SOP8
New BM1R00147F	2.7 to 32.0	SR	± 0.5	120	2.0	Self-restart	✓	✓	SOP8
New BM1R00148F	2.7 to 32.0	SR	± 0.5	120	3.0	Self-restart	✓	✓	SOP8
New BM1R00149F	2.7 to 32.0	SR	± 0.5	120	3.6	Self-restart	✓	✓	SOP8
New BM1R00150F	2.7 to 32.0	SR	± 0.5	120	4.6	Self-restart	✓	✓	SOP8

Isolated DC/DC Converter ICs

Isolated DC/DC Converter ICs													
Part No.	Output Power (W)	Input Voltage Maximum Rating(V)	Switch Current Limit(A)	Input Voltage Range (V)	Switching Frequency (kHz)	Control Mode	Features						Package
							Enable	Soft Start	Light-Load Efficiency	UVLO	Over-Current Protection	Thermal Protection	
BD7F100HFN-LB	1W at V _{IN} 5.0V	45	1.25	3.0 to 40	400	Adaptive on-time	✓	✓	✓	✓	Recovery	Recovery	HSOP8
BD7F100EFJ-LB	5W at V _{IN} 24V						✓	✓	✓	✓	Recovery	Recovery	HTSOP-J8
BD7F200HFN-LB	5W at V _{IN} 12V	45	2.75	8.0 to 40	400	Adaptive on-time	✓	✓	✓	✓	Recovery	Recovery	HSOP8
BD7F200EFJ-LB	10W at V _{IN} 24V						✓	✓	✓	✓	Recovery	Recovery	HTSOP-J8
☆BD7J200HFN-LA	10W at V _{IN} 48V	80	1.38	8.0 to 80	400	Adaptive on-time	✓	✓	✓	✓	Recovery	Recovery	HSOP8
☆BD7J200EFJ-LA							✓	✓	✓	✓	Recovery	Recovery	HTSOP-J8

☆ : Under Development

Isolated DC/DC Controller

Isolated DC/DC Controller									
Part No.	Topology	Primary/Secondary	Supply Voltage (V)	Switching Frequency(kHz)	Frequency Synchronization	I/F	Package	Automotive Grade AEC-Q100	
BD8325FVT-M	Active Clamp Forward	Primary IC	9 to 18	50 to 500	✓	—	TSSOP-B30	YES	

Gate Drivers

Isolated Gate Drivers

Isolated Gate Drivers												
Part No.	Input-side Supply Voltage(V)	Output-side Positive Supply Voltage(V)	Output-side Negative Supply Voltage(V)	Isolation Voltage (Vrms)	I/O Delay Time (ns)	Minimum Input Pulse Width(ns)	Maximum Output Current (A)	Operating Temperature (°C)	Function	Package	Automotive Grade AEC-Q100	
BM6101FV-C	4.5 to 5.5	14 to 24	-12 to 0	2,500	350	180	3	-40 to +125	Miller Clamp/Fail Output/Built-in under voltage lock out circuit/Thermal protection/Short current protection/DESAT/Soft turn-off function for short current protection	SSOP-B20W	YES	
BM6102FV-C	4.5 to 5.5	14 to 20	—	2,500	200	100	3	-40 to +125	Miller Clamp/Fail Output/Built-in under voltage lock out circuit/Thermal protection/Short current protection/DESAT/Soft turn-off function for short current protection	SSOP-B20W	YES	
BM6104FV-C	4.5 to 5.5	10 to 24	-12 to 0	2,500	150	90	3	-40 to +125	Miller Clamp/Fail Output/Built-in under voltage lock out circuit/Short current protection/DESAT/Soft turn-off function for short current protection	SSOP-B20W	YES	
BM60014FV-C	4.5 to 5.5	10 to 24	—	2,500	120	70	3	-40 to +125	Miller Clamp/Fail Output/Built-in under voltage lock out circuit	SSOP-B20W	YES	

Isolated Gate Driver(Industrial Equipment)

Part No.	Input-side Supply Voltage(V)	Output-side Positive Supply Voltage(V)	Output-side Negative Supply Voltage(V)	Isolation Voltage (Vrms)	I/O Delay Time (ns)	Minimum Input Pulse Width(ns)	Maximum Output Current (A)	Operating Temperature (°C)	Function	Package
BM6108FV-LB	4.5 to 5.5	10 to 24	-12 to 0	2,500	150	90	3	-40 to +105	Miller Clamp/Fail Output/Built-in under voltage lock out circuit/Short current protection/DESAT/Soft turn-off function for short current protection	SSOP-B20W

Isolated Gate Drivers with Flyback Controller

Part No.	Input-side Supply Voltage(V)	Output-side Positive Supply Voltage(V)	Output-side Negative Supply Voltage(V)	Isolation Voltage (Vrms)	I/O Delay Time (ns)	Minimum Input Pulse Width(ns)	Maximum Output Current (A)	Operating Temperature (°C)	Function	Package	Automotive Grade AEC-Q100
BM60051FV-C	4.5 to 24 4.5 to 5.5	9 to 24	—	2,500	260	180	5	-40 to +125	Miller Clamp/Fail Output/Built-in under voltage lock out circuit/Temperature Monitor/Short current protection/Soft turn-off function for short current protection	SSOP-B28W	YES
BM60055FV-C	4.5 to 30	9 to 24	—	2,500	250	170	5	-40 to +125	Miller Clamp/Fail Output/Built-in under voltage lock out circuit/Thermal protection/Short current protection/Soft turn-off function for short current protection/Over current protection/2 level turn off	SSOP-B28W	YES

Others

IGBT/MOSFET High-side Low-side Gate Drivers(Industrial Equipment)									
Part No	Input-side Supply Voltage(V)	High side Floating Supply Voltage(V)	I/O Delay Time (ns)	minimum Output Current(A)	Dead Time (ns)	Number of Channel	Operating Temperature (°C)	Package	
BS2101F	10 to 18	600	220	0.06/-0.13	—	2	-40 to +125	SOP8	
BS2103F	10 to 18	600	220	0.06/-0.13	160	2	-40 to +125	SOP8	
New BS2114F	10 to 20	600	250	0.5/-0.5	160	2	-40 to +125	SOP8	

IGBT/MOSFET High-side Low-side 3 Phase Bridge Driver(Industrial Equipment)									
Part No	Input-side Supply Voltage(V)	High side Floating Supply Voltage(V)	I/O Delay Time (ns)	Output Current (A)	Dead Time (ns)	Number of Channel	Operating Temperature (°C)	Package	
BS2130F-G	11.5 to 20	600	630/580	0.2/-0.35	300	6	-40 to +125	SOP28	

High Voltage Monitor

Isolated High Voltage Monitor

Part No.	Supply Voltage 1 (V)	Supply Voltage 2 (V)	Isolation Voltage (Vrms)	Circuit Current 1 (mA)	Circuit Current 2 (mA)	Output Duty Accuracy (%)	Operating Temperature (°C)	Package	Automotive Grade AEC-Q100
BM67290FV-C	8.0 to 24.0	3.0 to 5.5	2,500	4.6	0.2	±3.5	-40 to +125	SSOP-B20W	YES

Temperature Monitor

Isolated Temperature Monitor

Part No.	Supply Voltage 1 (V)	Supply Voltage 2 (V)	Isolation Voltage (Vrms)	Circuit Current 1 (mA)	Circuit Current 2 (mA)	Input Voltage Range (V)	Output Current Accuracy (%)	Output Duty Accuracy (%)	Operating Temperature (°C)	Package	Automotive Grade AEC-Q100
BM66002FV-C	9.0 to 24.0	3.0 to 5.5	2,500	3.75	0.2	1.4 to 4.0	±2.0	±2.0	-40 to +125	SSOP-B20W	YES

Power Management Switch

1 Channel Compact High Side Switch ICs

Part No.	Input Voltage (V)	ON Resistance (mΩ)	Control Input Logic	Output Current (A)	Over Current Detection(A) Min./Typ./Max.	Output Turn on Time (ms)	OCP	Thermal Shut Down	Flag Output Delay/ at Over Current (ms)	Discharge Resistance (Ω)	Package
BD6538G	2.7 to 5.5	150	H Active	0.5	0.5/-/1.0	1.0	Latch	Recovery	15	—	SSOP5
BD2220G	2.7 to 5.5	160	H Active	0.5	0.5/-/1.0	1.0	Latch	Recovery	15	—	SSOP5
BD2221G	2.7 to 5.5	160	L Active	0.5	0.5/-/1.0	1.0	Latch	Recovery	15	—	SSOP5
BD2224G	2.7 to 5.5	150	H Active	0.5	0.55/0.78/1.0	1.0	Recovery	Recovery	15	—	SSOP5
BD2225G	2.7 to 5.5	150	L Active	0.5	0.55/0.78/1.0	1.0	Recovery	Recovery	15	—	SSOP5
BD2226G	2.7 to 5.5	150	H Active	0.65	0.75/1.0/1.35	1.0	Recovery	Recovery	15	—	SSOP5
BD2227G	2.7 to 5.5	150	L Active	0.65	0.75/1.0/1.35	1.0	Recovery	Recovery	15	—	SSOP5
BD2232G	2.7 to 5.5	100	H Active	1.0	1.15/1.275/1.4	1.0	Recovery	Recovery	15	60	SSOP5
BD2233G	2.7 to 5.5	100	L Active	1.0	1.15/1.275/1.4	1.0	Recovery	Recovery	15	60	SSOP5
BD2240G	2.7 to 5.5	110	H Active	0.75	0.82/0.97/1.12	1.0	Recovery	Recovery	15	60	SSOP5
BD2241G	2.7 to 5.5	110	L Active	0.75	0.82/0.97/1.12	1.0	Recovery	Recovery	15	60	SSOP5
BD2246G	2.7 to 5.5	110	H Active	0.5	0.63/0.765/0.9	1.0	Recovery	Recovery	15	60	SSOP5
BD2247G	2.7 to 5.5	110	L Active	0.5	0.63/0.765/0.9	1.0	Recovery	Recovery	15	60	SSOP5
BD2248G	2.7 to 5.5	110	H Active	0.2	0.2/0.3/0.4	1.0	Recovery	Recovery	15	60	SSOP5
BD2222G*	2.8 to 5.5	90	H Active	1.5	0.2 to 1.7(adjutable)	0.6	Recovery	Recovery	7	—	SSOP6
BD2242G*	2.8 to 5.5	90	H Active	1.5	0.2 to 1.7(adjutable)	0.6	Recovery	Recovery	7	60	SSOP6
BD2243G*	2.8 to 5.5	90	L Active	1.5	0.2 to 1.7(adjutable)	0.6	Recovery	Recovery	7	60	SSOP6

New
New

Part No.	Input Voltage (V)	ON Resistance (mΩ)	Control Input Logic	Output Current (A)	Over Current Detection(A) Min./Typ./Max.	Output Turn on Time (ms)	OCP	Thermal Shut Down	Flag Output Delay/ at Over Current (ms)	Discharge Resistance (Ω)	Package	Automotive Grade AEC-Q100
BD22621G-M	2.7 to 5.5	120	H Active	0.15	0.18/0.30/0.42	1.0	Recovery	Recovery	15	60	SSOP5	YES
BD2262G-M	2.7 to 5.5	120	H Active	0.2	0.2/0.3/0.4	1.0	Recovery	Recovery	15	60	SSOP5	YES
BD22641G-M	2.7 to 5.5	120	H Active	0.5	0.57/0.76/0.96	1.0	Recovery	Recovery	15	60	SSOP5	YES
BD2264G-M	2.7 to 5.5	120	H Active	0.5	0.63/0.765/0.9	1.0	Recovery	Recovery	15	60	SSOP5	YES
BD2265G-M	2.7 to 5.5	120	L Active	0.5	0.63/0.765/0.9	1.0	Recovery	Recovery	15	60	SSOP5	YES
BD2266G-M	2.7 to 5.5	120	H Active	0.75	0.82/0.97/1.12	1.0	Recovery	Recovery	15	60	SSOP5	YES
BD2267G-M	2.7 to 5.5	120	L Active	0.75	0.82/0.97/1.12	1.0	Recovery	Recovery	15	60	SSOP5	YES
BD2268G-M	2.7 to 5.5	110	H Active	1.0	1.15/1.275/1.4	1.0	Recovery	Recovery	15	60	SSOP5	YES
BD2269G-M	2.7 to 5.5	110	L Active	1.0	1.15/1.275/1.4	1.0	Recovery	Recovery	15	60	SSOP5	YES
BD2244G-M*	2.8 to 5.5	100	H Active	1.5	0.2 to 1.7(adjutable)	0.6	Recovery	Recovery	7	60	SSOP6	YES
BD2245G-M*	2.8 to 5.5	100	L Active	1.5	0.2 to 1.7(adjutable)	0.6	Recovery	Recovery	7	60	SSOP6	YES

1 Channel Compact High Side Switch ICs(Industrial Equipment)

Part No.	Input Voltage (V)	ON Resistance (mΩ)	Control Input Logic	Output Current (A)	Over Current Detection(A) Min./Typ./Max.	Output Turn on Time (ms)	OCP	Thermal Shut Down	Flag Output Delay/ at Over Current (ms)	Discharge Resistance (Ω)	Package
BD6538G-LB	2.7 to 5.5	150	H Active	0.5	0.5/-/1.0	1.0	Latch	Recovery	15	—	SSOP5
BD2220G-LB	2.7 to 5.5	160	H Active	0.5	0.5/-/1.0	1.0	Latch	Recovery	15	—	SSOP5
BD2221G-LB	2.7 to 5.5	160	L Active	0.5	0.5/-/1.0	1.0	Latch	Recovery	15	—	SSOP5
BD2224G-LB	2.7 to 5.5	150	H Active	0.5	0.55/0.78/1.0	1.0	Recovery	Recovery	15	—	SSOP5
BD2225G-LB	2.7 to 5.5	150	L Active	0.5	0.55/0.78/1.0	1.0	Recovery	Recovery	15	—	SSOP5
BD2226G-LB	2.7 to 5.5	150	H Active	0.65	0.75/1.0/1.35	1.0	Recovery	Recovery	15	—	SSOP5
BD2227G-LB	2.7 to 5.5	150	L Active	0.65	0.75/1.0/1.35	1.0	Recovery	Recovery	15	—	SSOP5

*UL approved File No. E243261

1 Channel High Side Switch ICs												
Part No.	Input Voltage (V)	ON Resistance (mΩ)	Control Input Logic	Output Current (A)	Over Current Detection(A) Min./Typ./Max.	Output Turn on Time (ms)	OCP	Thermal Shut Down	Flag Output Delay/ at Over Current (ms)	Discharge Resistance (Ω)	Package	
BD2055AFJ	2.7 to 5.5	80	H Active	0.25	0.3/0.5/0.8	1.2	Recovery	Recovery	1.3	—	SOP-J8	
BD2045AFJ	2.7 to 5.5	80	L Active	0.25	0.3/0.5/0.8	1.2	Recovery	Recovery	1.3	—	SOP-J8	
BD6519FJ	3.0 to 5.5	100	L Active	0.5	0.7/1.1/1.6	1.0	Recovery	Recovery	2.5	—	SOP-J8	
BD2051AFJ	2.7 to 5.5	80	H Active	0.5	0.7/1.0/1.6	1.2	Recovery	Recovery	1.3	—	SOP-J8	
BD2041AFJ	2.7 to 5.5	80	L Active	0.5	0.7/1.0/1.6	1.2	Recovery	Recovery	1.3	—	SOP-J8	
BD82001FVJ	2.7 to 5.5	70	H Active	0.9	1.0/1.5/2.0	0.8	Recovery	Recovery	15	—	TSSOP-B8J	
BD82000FVJ	2.7 to 5.5	70	L Active	0.9	1.0/1.5/2.0	0.8	Recovery	Recovery	15	—	TSSOP-B8J	
BD2065AFJ	2.7 to 5.5	80	H Active	1.0	1.1/1.5/2.3	1.2	Recovery	Recovery	2.5	—	SOP-J8	
BD2061AFJ	2.7 to 5.5	80	L Active	1.0	1.1/1.5/2.3	1.2	Recovery	Recovery	2.5	—	SOP-J8	
BD82065FVJ	2.7 to 5.5	70	H Active	1.1	1.5/2.4/3.0	0.8	Recovery	Recovery	15	—	TSSOP-B8J	
BD82061FVJ	2.7 to 5.5	70	L Active	1.1	1.5/2.4/3.0	0.8	Recovery	Recovery	15	—	TSSOP-B8J	
BD82020FVJ*	2.8 to 5.5	90	H Active	1.1	1.1/1.5/2.0	0.4	Recovery	Recovery	12	75	TSSOP-B8J	
BD82021FVJ*	2.8 to 5.5	90	L Active	1.1	1.1/1.5/2.0	0.4	Recovery	Recovery	12	75	TSSOP-B8J	
BD82022FVJ*	2.8 to 5.5	90	H Active	1.5	1.5/2.0/2.6	0.4	Recovery	Recovery	12	75	TSSOP-B8J	
BD82023FVJ*	2.8 to 5.5	90	L Active	1.5	1.5/2.0/2.6	0.4	Recovery	Recovery	12	75	TSSOP-B8J	
BD82024FVJ*	2.8 to 5.5	90	H Active	2.1	2.1/2.5/3.3	0.4	Recovery	Recovery	12	75	TSSOP-B8J	
BD82025FVJ*	2.8 to 5.5	90	L Active	2.1	2.1/2.5/3.3	0.4	Recovery	Recovery	12	75	TSSOP-B8J	
BD82028FVJ*	4.5 to 5.5	72	H Active	0.5	0.6/1.0/1.2	0.3	Recovery	Recovery	13	75	TSSOP-B8J	
BD82029FVJ*	4.5 to 5.5	72	L Active	0.5	0.6/1.0/1.2	0.3	Recovery	Recovery	13	55	TSSOP-B8J	
BD82030FVJ*	4.5 to 5.5	72	H Active	1.0	1.05/1.5/1.8	0.3	Recovery	Recovery	13	55	TSSOP-B8J	
BD82031FVJ*	4.5 to 5.5	72	L Active	1.0	1.05/1.5/1.8	0.3	Recovery	Recovery	13	55	TSSOP-B8J	
BD82032FVJ*	4.5 to 5.5	72	H Active	1.5	1.55/2.0/2.3	0.3	Recovery	Recovery	13	55	TSSOP-B8J	
BD82033FVJ*	4.5 to 5.5	72	L Active	1.5	1.55/2.0/2.3	0.3	Recovery	Recovery	13	55	TSSOP-B8J	
BD82034FVJ*	4.5 to 5.5	72	H Active	2.0	2.05/2.5/2.8	0.3	Recovery	Recovery	13	55	TSSOP-B8J	
BD82035FVJ*	4.5 to 5.5	72	L Active	2.0	2.05/2.5/2.8	0.3	Recovery	Recovery	13	55	TSSOP-B8J	
Part No.	Input Voltage (V)	ON Resistance (mΩ)	Control Input Logic	Output Current (A)	Over Current Detection(A) Min./Typ./Max.	Output Turn on Time (ms)	OCP	Thermal Shut Down	Flag Output Delay/ at Over Current (ms)	Discharge Resistance (Ω)	Package	Automotive Grade AEC-Q100
BD82004FVJ-M	2.7 to 5.5	70	H Active	0.9	1.0/1.5/2.0	0.8	Recovery	Recovery	15	—	TSSOP-B8J	YES
BD82005FVJ-M	2.7 to 5.5	70	L Active	0.9	1.0/1.5/2.0	0.8	Recovery	Recovery	15	—	TSSOP-B8J	YES
BD82006FVJ-M	2.7 to 5.5	70	H Active	1.1	1.5/2.4/3.0	0.8	Recovery	Recovery	15	—	TSSOP-B8J	YES
BD82007FVJ-M	2.7 to 5.5	70	L Active	1.1	1.5/2.4/3.0	0.8	Recovery	Recovery	15	—	TSSOP-B8J	YES
1 Channel High Side Switch ICs(Industrial Equipment)												
Part No.	Input Voltage (V)	ON Resistance (mΩ)	Control Input Logic	Output Current (A)	Over Current Detection(A) Min./Typ./Max.	Output Turn on Time (ms)	OCP	Thermal Shut Down	Flag Output Delay/ at Over Current (ms)	Discharge Resistance (Ω)	Package	
BD82001FVJ-LB	2.7 to 5.5	70	H Active	0.9	1.0/1.5/2.0	0.8	Recovery	Recovery	15	—	TSSOP-B8J	
BD82000FVJ-LB	2.7 to 5.5	70	L Active	0.9	1.0/1.5/2.0	0.8	Recovery	Recovery	15	—	TSSOP-B8J	
BD82065FVJ-LB	2.7 to 5.5	70	H Active	1.1	1.5/2.4/3.0	0.8	Recovery	Recovery	15	—	TSSOP-B8J	
BD82061FVJ-LB	2.7 to 5.5	70	L Active	1.1	1.5/2.4/3.0	0.8	Recovery	Recovery	15	—	TSSOP-B8J	
2 Channel High Side Switch ICs												
Part No.	Input Voltage (V)	ON Resistance (mΩ)	Control Input Logic	Output Current (A)	Over Current Detection(A) Min./Typ./Max.	Output Turn on Time (ms)	OCP	Thermal Shut Down	Flag Output Delay/ at Over Current (ms)	Discharge Resistance (Ω)	Package	
BD2056AFJ	2.7 to 5.5	100	H Active	0.3	0.3/0.5/0.9	1.8	Recovery	Recovery	1.3	—	SOP-J8	
BD2046AFJ	2.7 to 5.5	100	L Active	0.3	0.3/0.5/0.9	1.8	Recovery	Recovery	1.3	—	SOP-J8	
BD6516F*	3.0 to 5.5	110	H Active	1.1	1.2/1.65/2.5	1.3	Recovery	Recovery	1.0	—	SOP8	
BD6517F*	3.0 to 5.5	110	L Active	1.1	1.2/1.65/2.5	1.3	Recovery	Recovery	1.0	—	SOP8	
BD2052AFJ	2.7 to 5.5	100	H Active	0.6	0.7/1.0/1.8	1.8	Recovery	Recovery	1.3	—	SOP-J8	
BD2042AFJ	2.7 to 5.5	100	L Active	0.6	0.7/1.0/1.8	1.8	Recovery	Recovery	1.3	—	SOP-J8	
BD2066FJ*	2.7 to 5.5	80	H Active	1.0	1.5/2.4/3.0	0.8	Recovery	Recovery	15	—	SOP-J8	
BD2062FJ*	2.7 to 5.5	80	L Active	1.0	1.5/2.4/3.0	0.8	Recovery	Recovery	15	—	SOP-J8	
Part No.	Input Voltage (V)	ON Resistance (mΩ)	Control Input Logic	Output Current (A)	Over Current Detection(A) Min./Typ./Max.	Output Turn on Time (ms)	OCP	Thermal Shut Down	Flag Output Delay/ at Over Current (ms)	Discharge Resistance (Ω)	Package	Automotive Grade AEC-Q100
BD2068FJ-M	2.7 to 5.5	80	H Active	1.0	1.5/2.4/3.0	0.8	Recovery	Recovery	15	—	SOP-J8	YES
BD2069FJ-M	2.7 to 5.5	80	L Active	1.0	1.5/2.4/3.0	0.8	Recovery	Recovery	15	—	SOP-J8	YES
2 Channel High Side Switch ICs(Industrial Equipment)												
Part No.	Input Voltage (V)	ON Resistance (mΩ)	Control Input Logic	Output Current (A)	Over Current Detection(A) Min./Typ./Max.	Output Turn on Time (ms)	OCP	Thermal Shut Down	Flag Output Delay/ at Over Current (ms)	Discharge Resistance (Ω)	Package	
BD2066FJ-LB*	2.7 to 5.5	80	H Active	1.0	1.5/2.4/3.0	0.8	Recovery	Recovery	15	—	SOP-J8	
BD2062FJ-LB*	2.7 to 5.5	80	L Active	1.0	1.5/2.4/3.0	0.8	Recovery	Recovery	15	—	SOP-J8	

*UL approved File No. E243261

Load Switch ICs

Part No.	Input Voltage (V)	Current Consumption (μA)	ON Resistance (mΩ)	Number of Output channel (ch)	Control Input Logic	Output Current (A)	Over Current Detection(A) Min./Typ./Max.	Output Turn on Time (ms)	Thermal Shut Down	Discharge Resistance (Ω)	Package (mm)
BD6524HFV	3.0 to 5.5	50	200	1	H Active	0.5	—	0.4	—	200	HVSO6
BD6528HFV	V _{DD} =2.7 to 4.5 V _{IN} =0.0 to 2.7	20	110	1	H Active	0.5	—	0.5	—	70	HVSO6
BD6529GUL	V _{DD} =2.7 to 4.5 V _{IN} =0.0 to 2.7	20	100	1	H Active	0.5	—	0.5	—	70	VCSP50L1 (1.0×1.5) H=0.55
BD2200GUL	2.7 to 5.5	20	100	1	H Active	0.5	—	1.0	—	70	VCSP50L1 (1.0×1.5) H=0.55
BD2201GUL	2.7 to 5.5	20	100	1	H Active	1.0	—	1.0	—	70	VCSP50L1 (1.0×1.5) H=0.55
BD2204GUL	V _{IN1} =2.7 to 4.5 V _{IN2} =1.2 to 2.4	30	120	1	H Active	0.5	—	0.06	Recovery	80	VCSP50L1 (1.0×1.5) H=0.55
BD2202G	2.7 to 3.6	70	150	1	H Active	0.2	0.25/—/1.0	1.2	Recovery	—	SSOP5
BD2206G	2.7 to 3.6	70	150	1	H Active	0.5	0.8/—/1.6	1.2	Recovery	—	SSOP5
BD6520F	3 to 5.5	110	50	1	H Active	2.0	—	2.0	Latch	350	SOP8
BD6522F	3 to 5.5	110	50	1	H Active	2.0	—	1.0	Latch	350	SOP8

Load Switch ICs(Industrial Equipment)

BD2202G-LB	2.7 to 3.6	70	150	1	H Active	0.2	0.25/—/1.0	1.2	Recovery	—	SSOP5
BD2206G-LB	2.7 to 3.6	70	150	1	H Active	0.5	0.8/—/1.6	1.2	Recovery	—	SSOP5

1 Channel Compact High Side Load Switch ICs

Part No.	Input Voltage (V)	Current Consumption (μA)	ON Resistance (mΩ)	Number of Output channel (ch)	Control Input Logic	Output Current (A)	Over Current Detection(A) Min.	Output Turn on Time (ms)	Thermal Shut Down	Discharge Resistance (Ω)	Package (mm)
BUS1DJC0GWZ	1.1 to 5	0.35	63	1	H Active	2	—	0.012	—	80	UCSP30L1 (0.8×0.8) H=0.35
BUS1DJC3GWZ	1.1 to 5	0.35	63	1	H Active	2	—	0.19	—	80	UCSP30L1 (0.8×0.8) H=0.35

2 Channel Compact High Side Load Switch IC

BDS2EJAAGUL	3 to 3.6	0.2	45	2	H Active	1	1.0	— (Soft Start)	Recovery	30	VCSP50L1 (1.95×1.0) H=0.55
-------------	----------	-----	----	---	----------	---	-----	-------------------	----------	----	-------------------------------

Controller IC for High Side NMOSFET

Part No.	Input Voltage (V)	Current Consumption (μA)	Output Voltage(V)		Number of Output channel (ch)	Control Input Logic	Output Turn on Time (ms)	Discharge Resistance (Ω)	Package
			V _{CC} =3.3V	V _{CC} =5.0V					
BD2270HFV	2.7 to 5.5	50	9.5	13.5	1	H Active	0.13	200	HVSO5

Controller IC for High Side NMOSFET(Industrial Equipment)

BD2270HFV-LB	2.7 to 5.5	50	9.5	13.5	1	H Active	0.13	200	HVSO5
--------------	------------	----	-----	------	---	----------	------	-----	-------

Wireless Power

Receiver ICs(WPC(Qi) v1.2 and AirFuel Inductive)

Part No.	Wireless Power Standard	Output Power (W)	Output Voltage (V)	Input Voltage (V)	Operating Frequency (A)	Operating Frequency (KHz)	Operating Temperature (°C)	Package (mm)
New BD57011AGWL	WPC(Qi) v1.2	5	4.3 to 5.3	20	1.1	210	−20 to +85	UCSP50L3C (3.36x2.62) H=0.57Max.
BD57015GWL	WPC(Qi) v1.2 and AirFuel Inductive	15	5.0 to 12	20	1.5	480	−30 to +85	UCSP50L4C (4.10x3.2) H=0.57Max.

Transmitter ICs(WPC(Qi) v1.2)

Part No.	Wireless Power Standard	Tx Type	Output Power (W)	Operating Temperature (°C)	Recommendation MCU	Package (mm)
BD57021MWV	WPC(Qi) v1.2	LP-A11	5	−20 to +85	ML610Q772	UQFN040V5050 (5.0x5.0) H=1.0Max.
BD57020MWV	WPC(Qi) v1.2	MP-A7	15	−20 to +85	ML610Q772	UQFN040V5050 (5.0x5.0) H=1.0Max.

(LAPIS Semiconductor products)

Power Receiver LSI(13.56MHz Wireless Charge)

Part No.	Functions	Supply Voltage	Frequency Band (MHz)	Data Flash	Charging Control	I/F	ADC (method)	Clock Source	Operating Temperature (°C)	Package	Halogen Free Support
New ML7630	Power Receiving Control	Generated from magnetic field	0.2	2K	Charging Output Voltage/Current setting	I ² C slave×1ch I ² C master×1ch UART×1ch	10bit (SA type) ×1ch	—	−40 to +85	WL-CSP34	✓

Power Transmitter LSI(13.56MHz Wireless Charge)

Part No.	Functions	Supply Voltage (V)	Frequency Band (MHz)	Data Flash	Charging Control	I/F	ADC (method)	Clock Source	Operating Temperature (°C)	Package	Halogen Free Support
New ML7631	Power Transmission Control	5	6.78	2K	—	I ² C slave×1ch I ² C master×1ch UART×1ch	10bit (SA type) ×1ch	—	−40 to +85	WQFN32	✓

Battery Management

Battery Charger ICs							
Part No.	Supply Voltage (V)	ON Resistance (mΩ)	Charge Voltage (V)	Charge Current Accuracy(%)	Switching Frequency (kHz)	Operating Temperature (°C)	Package
BD8664GW	4.1 to 5.5	70	8.3±0.5%	± 2	1,000	-30 to +85	UCSP75M2
BD8665GW	4.1 to 5.5	70	8.4±0.5%	± 3	1,000	-30 to +85	UCSP75M2
BD8668GW	4.1 to 5.5	70	8.4±0.5%	± 3	1,000	-30 to +85	UCSP75M2
BD99950MUV	6 to 24	—	8.4/12.6±0.5%	± 3	600 to 1,200	-10 to +85	VQFN020PV3535

Solar Charge Management IC						
Part No.	Supply Voltage (V)	Charge Current (mA)	Switching Frequency (kHz)	Over Current Detection Level(A)	MPPT	Package (mm)
BU1840AMUV	0.625 to 1.98	400	160, 320	Min. 3.0	✓	VQFN024V4040 (4.1×4.1) H=1.0 Max.

Charge Protection ICs

Standard Protection type									
Part No.	Absolute Maximum Ratings(V)	Over Voltage Detection Level(V)	Under Voltage Detection Level(V)	Over Current Detection Level(A)	Ron (mΩ)	OK/FLGB PIN Logic			Package (mm)
						<UVLO	Normal	>OVLO	
BD6040GUL	+30	6.4 ± 0.2	2.65 ± 0.12	Min. 1.2	125(Typ.)	H	L	H	VCSP50L1 (1.6×1.6) H=0.55 Max.
BD6041GUL	+30	5.85 ± 0.15	2.65 ± 0.12	Min. 1.2	125(Typ.)	H	L	H	VCSP50L1 (1.6×1.6) H=0.55 Max.
BD6042GUL	+30	6.2 ± 0.2	2.65 ± 0.12	Min. 1.2	125(Typ.)	H	L	H	VCSP50L1 (1.6×1.6) H=0.55 Max.
BD6044GUL	+36	6.4 ± 0.2	2.65 ± 0.12	Min. 1.2	125(Typ.)	H	H	L	VCSP50L1 (1.6×1.6) H=0.55 Max.
BD6049GUL	+30	6.8 ± 0.17	2.65 ± 0.12	Min. 1.2	125(Typ.)	H	H	L	VCSP50L1 (1.6×1.6) H=0.55 Max.
BD91409GW	+30	6.25 ± 0.15	3.125 ± 0.1	Min. 2.0	75(Typ.)	—	—	—	UCSP75M2 (2.8×2.8) H=0.85 Max.

Negative Voltage Protection type									
Part No.	Absolute Maximum Ratings(V)	Over Voltage Detection Level(V)	Under Voltage Detection Level(V)	Over Current Detection Level(A)	Ron (mΩ)	<UVLO	Normal	>OVLO	Package (mm)
BD6046GUL	± 30	6.7 ± 0.2	3.6 ± 0.18	Min. 1.2	250(Typ.)	H	H	L	VCSP50L2 (2.5×2.5) H=0.55 Max.
BD6047AGUL	± 30	5.85 ± 0.15	3.6 ± 0.18	Min. 1.7	125(Typ.)	H	H	L	VCSP50L1 (1.95×1.95) H=0.55 Max.

Standard Protection Type : Charger protection IC provides over voltage protection for charger IC. Built-in circuits include overvoltage lockout, overcurrent limit, undervoltage protection, internal start up delay, and status flag.

Negative Voltage Protection Type : Addition to the conventional standard charge protection IC, it prevents the negative voltage happened by the USB reverse insertion without any additional components.

Cell Balance IC of Power Storage Element Cells

EDLC Cell Balance IC(4 to 6 series)									
Part No.	Absolute Maximum Ratings(V)	Cell Voltage Detection RangeVCB(V)	Over-voltage Detection Voltage1(V)	Over-voltage Detection Voltage2(V)	Shunt SW Ron (Ω)	Function			Package (mm)
						EN	OVLO	Stack IC	
BD14000EFV-C	+28	2.4 to 3.1V ± (1%) (0.1V/step usable)	VCB+0.15 or 0.25 (OVLOSEL = L or H)	VCB+0.3 or 0.5 (OVLOSEL = L or H)	1 (Typ.)	✓	✓	✓	HTSSOP-B30 (10.0×7.6) H=1.0 Max.

Li-ion Battery Monitoring LSIs

(LAPIS Semiconductor products)

Stand-alone type														
Part No.	Description	Supply Voltage (V)	Overvoltage Detection/ Measurement Accuracy (Typ.) (Note1)	FET Driver for Charge-Discharge Control	Current Consumption(Typ.)		Overvoltage and Undervoltage Detection	Charge and Discharge Over-Current Detection	Open Wire Detection	Short Circuit Detection	Setting Threshold	Operation Temperature (°C)	Package	Halogen Free Support
					Operating	Power-down								
ML5203	4 to 7-cells supported, battery cell voltage and current protection LSI	+5 to +42	±25mV	NMOS	30μA	0.1μA	✓	✓	—	—	Mask option	-40 to +85	SSOP30	—
ML5232	5 to 14-cells supported, 2nd protection LSI	+7 to +80	±20mV	—	2.5μA	—	Overvoltage detection	—	—	—	Mask option	-40 to +105	TSSOP20	✓
ML5233	4 to 10-cells supported, cell voltage, current and temperature protection LSI	+5 to +60	±15mV	NMOS	25μA	0.1μA	✓	✓	—	✓	Mask option	-40 to +85	LQFP32	✓
ML5235	5 to 13-cells supported, cell voltage and current protection LSI	+7 to +80	±25mV	NMOS	25μA	0.1μA	✓	✓	—	—	Mask option	-40 to +85	SSOP30	✓
New ML5241	3 to 5-cells supported, cell voltage, open wire protection LSI	+5 to +25	±25mV	—	1μA	0.1μA	Overvoltage detection	—	✓	—	Mask option	-20 to +85	WSOP10	✓
New ML5245	5 to 13-cells supported, cell voltage, current and temperature protection LSI	+7 to +80	±15mV	NMOS	25μA	0.1μA	✓	✓	—	✓	Mask option	-40 to +85	SSOP30	—

Analog Frontend type														
Part No.	Description	Supply Voltage (V)	Overvoltage Detection/ Measurement Accuracy (Typ.) (Note1)	FET Driver for Charge-Discharge Control	Current Consumption(Typ.)		Overvoltage and Undervoltage Detection	Charge and Discharge Over-Current Detection	Open Wire Detection	Short Circuit Detection	Setting Threshold	Operation Temperature (°C)	Package	Halogen Free Support
					Operating	Power-down								
New ML5204	4 to 5-cells supported, cell voltage and current monitoring LSI, with cell balancing switch, overvoltage/undervoltage/overcurrent detection status	+3.3 to +42	±25mV	—	14μA	—	✓	✓	—	✓	Mask option	-40 to +85	TSSOP20	✓
ML5238	16 cells supported, cell voltage and current monitoring LSI with cell balancing switch	+7 to +80	±20mV	NMOS	50μA	0.1μA	—	—	—	✓	MCU control	-40 to +85	QFP44	✓
ML5236	14 cells supported, cell voltage, current and temperature monitoring LSI with integrated ADC and cell balancing switch	+8 to +64	±15mV	High-side NMOS	330μA	0.1μA	Overvoltage detection	—	—	✓	MCU control	-40 to +85	TQFP44	✓
ML5239	16 cells supported, cell voltage and temperature monitoring LSI with integrated ADC and cell balancing driver	+10 to +72	±10mV	—	1.2mA	0.1μA	—	—	—	—	MCU control	-40 to +85	TQFP64	✓
New ML5248	7 cells supported, cell voltage and current monitoring LSI with cell balancing switch	+5 to +31.5	±20mV	High-side NMOS	32μA	0.1μA	—	—	—	✓	MCU control	-40 to +85	SSOP30	—

Dedicated Controller									
Part No.	Description	Supply Voltage(V)		AD Converter	Current Consumption (Typ.)			Package	Halogen Free Support
		V _{DD}	AV _{DD}		Operating	Suspended(HALT)	Shutdown		
ML610Q486P	nX-U8/100, 32KB Flash, 1KB RAM, Master Clock 500kHz	1.6 to 3.6	2.2 to 3.6	12bit, 4ch	400μA	15μA	0.2μA	TQFP48	✓
ML610Q488P	nX-U8/100, 48KB Flash with ECC, 2KB RAM, Master Clock 1MHz	1.8 to 3.6	2.2 to 3.6	10bit, 3ch	175μA	1.4μA	0.2μA	TQFP48	✓

Note1 : Overvoltage Detection Accuracy for Stand-alone type, Measurement Accuracy for Analog Frontend type.

A check mark of halogen free support means that we will be able to ship out the halogen free products. For details, please inquire to the sales.

General-purpose ICs

Voltage Detectors(Reset ICs)

Voltage Detectors(Reset ICs)

**Voltage Detectors
(Reset ICs)** ▶P.A64

**Voltage Detectors
with Adjustable Delay Time** ▶P.A65

**Voltage Detectors
with Built-in Delay Time** ▶P.A65

**Voltage Detectors
for Automotive** ▶P.A66

**Voltage Detectors
with Watchdog Timer** ▶P.A66

**Composite type Voltage Detectors
(2ch+Comparator)** ▶P.A66

Voltage Detectors How to find part number

B D 4 8 K 2 5 5 F V E — M

Series

Series Option

Voltage Detection Value

Reset Delay Time

Package

Product Grade

48: Without Delay Time, Open-Drain Output type
 49: Without Delay Time, CMOS Output type
 45: Fixed Delay Time, Open-Drain Output type
 46: Fixed Delay Time, CMOS Output type
 52: Adjustable Delay Time, Open-Drain Output type
 53: Adjustable Delay Time, CMOS Output type
 47: Without Delay Time, Open-Collector Output type (Bipolar)
 71: Without Delay Time, Open-Drain Output type

E / None: SSOP5(SOT23-5)/HVSOF5 / SOP4(SC82)
 K: SSOP3(SOT23-3) 1pin:GND
 L: SSOP3(SOT23-3) 3pin:GND

None: Without/Adjustable Delay Time
 5: 50ms
 1: 100ms
 2: 200ms
 4: 400ms

G: SSOP5(SOT23-5)
 SSOP3(SOT23-3)
 FVE: VSOF5
 F: SOP4(SC82)
 HFV: HVSOF5

None: For Consumer
 M: For Car Infotainment
 C: For Car

Voltage Detectors(Reset ICs)

Voltage Detectors(Reset ICs)

Standard CMOS Voltage Detector ICs

Part No.	Types	Voltage Detection Precision (%)	Voltage Detection (V)	RESET Active Voltage Range (V)	Detection Step (V)	Output Type	Circuit Current(μA)		Hysteresis Voltage (V)	*L*Output Current(mA)		Package
							ON	OFF		V _{DD} =1.2V	V _{DD} =2.4V	
BD48ExxG series	0.1V step 38 type	±1	2.3 to 6.0	0.95 to 10.0	0.1	Open drain	0.60 (Vs=4.8V)	0.85 (Vs=4.8V)	Vs×0.05	1	4	SSOP5
BD48xxFVE series	0.1V step 38 type	±1	2.3 to 6.0	0.95 to 10.0	0.1							VSOF5
BD48KxxG series	0.1V step 38 type	±1	2.3 to 6.0	0.95 to 10.0	0.1							SSOP3(GND 1pin)
BD48LxxG series	0.1V step 38 type	±1	2.3 to 6.0	0.95 to 10.0	0.1							SSOP3(GND 3pin)
BD49ExxG series	0.1V step 38 type	±1	2.3 to 6.0	0.95 to 10.0	0.1	CMOS	0.60 (Vs=4.8V)	0.85 (Vs=4.8V)	Vs×0.05	1	4	SSOP5
BD49xxFVE series	0.1V step 38 type	±1	2.3 to 6.0	0.95 to 10.0	0.1							VSOF5
BD49KxxG series	0.1V step 38 type	±1	2.3 to 6.0	0.95 to 10.0	0.1							SSOP3(GND 1pin)
BD49LxxG series	0.1V step 38 type	±1	2.3 to 6.0	0.95 to 10.0	0.1							SSOP3(GND 3pin)

*Detection voltage (from 2.3V to 6.0V as 0.1V step) is applied in the xx of part No.. Ex : In case of 2.3V detection voltage in BD48ExxG series, part No. is BD48E23G.

Voltage Detector ICs(Low Voltage Detection type)												
Part No.	Types	Voltage Detection Precision (%)	Voltage Detection (V)	RESET Active Voltage Range (V)	Detection Step (V)	Output Type	Circuit Current(μA)		Hysteresis Voltage(V)	*L*Output Current(mA)		Package
							ON	OFF		V _{DD} =1.2V	V _{DD} =2.4V	
BU48xxG series	0.1V step 40 type	±1	0.9 to 4.8	0.7 to 7.0	0.1	Open drain	0.40 (V _{DET} =4.8V)	0.55 (V _{DET} =4.8V)	V _{DET} × 0.05	3.3	6.5	SSOP5
BU48xxFVE series	0.1V step 40 type	±1	0.9 to 4.8	0.7 to 7.0	0.1							VSO5F5
BU48xxF series	0.1V step 40 type	±1	0.9 to 4.8	0.7 to 7.0	0.1							SOP4
BU49xxG series	0.1V step 40 type	±1	0.9 to 4.8	0.7 to 7.0	0.1	CMOS	0.40 (V _{DET} =4.8V)	0.55 (V _{DET} =4.8V)	V _{DET} × 0.05	3.3	6.5	SSOP5
BU49xxFVE series	0.1V step 40 type	±1	0.9 to 4.8	0.7 to 7.0	0.1							VSO5F5
BU49xxF series	0.1V step 40 type	±1	0.9 to 4.8	0.7 to 7.0	0.1							SOP4

Bipolar Voltage Detector ICs

Part No.	Types	Voltage Detection Precision (%)	Voltage Detection (V)	RESET Active Voltage Range (V)	Detection Step (V)	Output Type	Circuit Current (μA)		Hysteresis Voltage(mV)	*L*Output Current (mA)	Package
							I _{CC1}	I _{CC2}			
BD47xxG series	0.1V step 28 type	±1	1.9 to 4.6	0.85 to 10.0	0.1	Open collector	1.5	1.6	50	15	SSOP5

Over Voltage Detector ICs

Part No.	Types	Voltage Detection Precision (%)	Voltage Detection (V)	RESET Active Voltage Range (V)	Detection Step (V)	Output Type	I _{CC1}	I _{CC2}	Hysteresis Voltage(mV)	*L*Output Current (mA)	Package
BD71L4Lx-1 series	2 type	±0.8	4.05	1.2 to 7.0	—	Open drain	0.6	0.7	0.03	4 (V _{DD} =4.25V)	SSOP5 HVSO5F5

Voltage Detector ICs(Low Voltage Detection Type): Detection voltage(from 0.9V to 4.8V as 0.1V step) is applied in the xx of part No.. Ex : In case of 2.3V detection voltage in BU48xxG series, part No. is BU4823G.
 Bipolar Voltage Detector ICs : *Detection voltage(from 1.9V to 4.6V as 0.1V step) is applied in the xx of part No.. Ex : In case of 2.3V detection voltage in BD47xxG series, part No. is BD4723G.

Voltage Detectors with Adjustable Delay Time

Part No.	Types	Voltage detection precision at Ta=25°C (%)	Voltage Detection (V)	RESET Active Voltage Range (V)	Detection Step (V)	Output Type	Circuit Current(μA)		Hysteresis Voltage (V)	*L*Output Current (mA)		RESET Active Timeout Period (ms)	Delay Circuit Resistance (MΩ)	Package
							ON	OFF		V _{DD} =1.2V	V _{DD} =2.4V			
BD52ExxG series	0.1V step 38 type	±1	2.3 to 6.0	0.95 to 10.0	0.1	Open drain	0.90 (V _{DET} =4.8V)	0.85 (V _{DET} =4.8V)	V _{DET} × 0.05	1.2	5.0	Variable	9	SSOP5
BD52xxFVE series	0.1V step 38 type	±1	2.3 to 6.0	0.95 to 10.0	0.1									VSO5F5
BD53ExxG series	0.1V step 38 type	±1	2.3 to 6.0	0.95 to 10.0	0.1	CMOS	0.90 (V _{DET} =4.8V)	0.85 (V _{DET} =4.8V)	V _{DET} × 0.05	1.2	5.0	Variable	9	SSOP5
BD53xxFVE series	0.1V step 38 type	±1	2.3 to 6.0	0.95 to 10.0	0.1									VSO5F5

Voltage Detectors with Adjustable Delay Time(Low Voltage Detection type)

Part No.	Types	Voltage Detection Precision (%)	Voltage Detection (V)	RESET Active Voltage Range (V)	Detection Step (V)	Output Type	Circuit Current(μA)		Hysteresis Voltage (V)	*L*Output Current (mA)		RESET Active Timeout Period (ms)	Delay Circuit Resistance (MΩ)	Package
							ON	OFF		V _{DD} =1.2V	V _{DD} =2.4V			
BU42xxG series	0.1V step 40 type	±1	0.9 to 4.8	0.7 to 7.0	0.1	Open drain	0.40 (V _{DET} =4.8V)	0.55 (V _{DET} =4.8V)	V _{DET} × 0.05	3.3	6.5	Variable	10	SSOP5
BU42xxFVE series	0.1V step 40 type	±1	0.9 to 4.8	0.7 to 7.0	0.1									VSO5F5
BU42xxF series	0.1V step 40 type	±1	0.9 to 4.8	0.7 to 7.0	0.1	CMOS	0.40 (V _{DET} =4.8V)	0.55 (V _{DET} =4.8V)	V _{DET} × 0.05	3.3	6.5	Variable	10	SOP4
BU43xxG series	0.1V step 40 type	±1	0.9 to 4.8	0.7 to 7.0	0.1									SSOP5
BU43xxFVE series	0.1V step 40 type	±1	0.9 to 4.8	0.7 to 7.0	0.1									VSO5F5
BU43xxF series	0.1V step 40 type	±1	0.9 to 4.8	0.7 to 7.0	0.1									SOP4

Voltage Detector with Adjustable Delay Time(SENSE type)

Part No.	Voltage Detection Precision at Ta=25°C (%)	Voltage Detection (V)	Power Supply Voltage Range (V)	Output Type	Circuit Current (μA)	Hysteresis Voltage (V)	Output ON Resistance (Ω)	RESET Active Timeout Period (ms)	Package
BD4142HFV	±1.8	0.5	3 to 5.5	Open drain	7.5	0.01	100	Variable	HVSO5F5

Adjustable Delay Time Setting Voltage Detector ICs : Detection voltage(from 2.3V to 6.0V as 0.1V step) is applied in the xx of part No.. Ex : In case of 2.3V detection voltage in BD52ExxG series, part No. is BD52E23G.
 Adjustable Delay Time Setting Voltage Detector ICs(Low Voltage Detection Type) : Detection voltage(from 0.9V to 4.8V as 0.1V step) is applied in the xx of part No.. Ex : In case of 2.3V detection voltage in BU42xxG series, part No. is BU4223G.

Voltage Detectors with Built-in Delay Time

Part No.	Types	Voltage Detection Precision (%)	Voltage Detection (V)	RESET Active Voltage Range (V)	Detection Step (V)	Output Type	Circuit Current(μA)		Hysteresis Voltage (V)	*L*Output current(mA)		RESET Active Timeout Period (ms)	Manual Reset PIN	Package				
							ON	OFF		V _{DD} =1.2V	V _{DD} =2.4V							
BD45xx5G series	0.1V step 26 type	±1	2.3 to 4.8	0.95 to 10.0	0.1	Open drain	0.80 (V _{DET} =4.8V)	0.85 (V _{DET} =4.8V)	V _{DET} × 0.05	1.2	5.0	50	Yes	SSOP5				
BD45xx1G series	0.1V step 26 type	±1	2.3 to 4.8	0.95 to 10.0	0.1									100	Yes	SSOP5		
BD45xx2G series	0.1V step 26 type	±1	2.3 to 4.8	0.95 to 10.0	0.1									200	Yes	SSOP5		
BU45Kxx2G series	0.1V step 26 type	±1	2.3 to 4.8	0.6 to 10.0	0.1		2.3 (V _{DET} =4.8V)	2.8 (V _{DET} =4.8V)						200	No	SSOP3(GND 1pin)		
BU45Lxx2G series	0.1V step 26 type	±1	2.3 to 4.8	0.6 to 10.0	0.1											200	No	SSOP3(GND 3pin)
BU45Kxx4G series	0.1V step 26 type	±1	2.3 to 4.8	0.6 to 10.0	0.1											0.80 (V _{DET} =4.8V)	0.85 (V _{DET} =4.8V)	400
BU45Lxx4G series	0.1V step 26 type	±1	2.3 to 4.8	0.6 to 10.0	0.1	400	No	SSOP3(GND 3pin)										
BD46xx5G series	0.1V step 26 type	±1	2.3 to 4.8	0.95 to 10.0	0.1	CMOS	0.80 (V _{DET} =4.8V)	0.85 (V _{DET} =4.8V)	V _{DET} × 0.05	1.2	5.0	50	Yes	SSOP5				
BD46xx1G series	0.1V step 26 type	±1	2.3 to 4.8	0.95 to 10.0	0.1									100	Yes	SSOP5		
BD46xx2G series	0.1V step 26 type	±1	2.3 to 4.8	0.95 to 10.0	0.1									200	Yes	SSOP5		
BU46Kxx2G series	0.1V step 26 type	±1	2.3 to 4.8	0.6 to 10.0	0.1		2.3 (V _{DET} =4.8V)	2.8 (V _{DET} =4.8V)						200	No	SSOP3(GND 1pin)		
BU46Lxx2G series	0.1V step 26 type	±1	2.3 to 4.8	0.6 to 10.0	0.1											200	No	SSOP3(GND 3pin)
BU46Kxx4G series	0.1V step 26 type	±1	2.3 to 4.8	0.6 to 10.0	0.1											0.80 (V _{DET} =4.8V)	0.85 (V _{DET} =4.8V)	400
BU46Lxx4G series	0.1V step 26 type	±1	2.3 to 4.8	0.6 to 10.0	0.1	400	No	SSOP3(GND 3pin)										
BU46Lxx4G series	0.1V step 26 type	±1	2.3 to 4.8	0.6 to 10.0	0.1	400	No	SSOP3(GND 3pin)										

*Detection voltage(from 2.3V to 4.8V as 0.1V step) is applied in the xx of part No.. Ex : In case of 2.3V detection voltage in BD45xx5G series, part No. is BD45235G.

Voltage Detectors for Automotive

105°C Corresponding																
Part No.	Types	Voltage Detection Precision at T _{amb} =25°C (%)	Voltage Detection (V)	RESET Active Voltage Range (V)	Detection Step (V)	Output Type	Circuit Current(μA)		Hysteresis Voltage (V)	*L*Output Current (mA)		RESET Active Timeout Period (ms)	Delay Circuit Resistance (MΩ)	Manual Reset PIN	Package	Automotive Grade AEC-Q100
							ON	OFF		V _{DD} =1.2V	V _{DD} =2.4V					
BD48ExxG-M series	0.1V step 38 type	±1	2.3 to 6.0	0.95 to 10.0	0.1	Open drain	0.60 (V _S =4.8V)	0.85 (V _S =4.8V)	V _S ×0.05	1.0	4	—	—	No	SSOP5	YES
BD49ExxG-M series	0.1V step 38 type	±1	2.3 to 6.0	0.95 to 10.0	0.1	CMOS						—	—	No	SSOP5	YES
BD45Exx5G-M series	0.1V step 26 type	±1	2.3 to 4.8	0.95 to 10.0	0.1	Open drain	0.80 (V _{DET} =4.8V)	0.85 (V _{DET} =4.8V)	V _{DET} ×0.05	1.2	5	50	—	Yes	SSOP5	YES
BD45Exx1G-M series	0.1V step 26 type	±1	2.3 to 4.8	0.95 to 10.0	0.1							100	—	Yes	SSOP5	YES
BD45Exx2G-M series	0.1V step 26 type	±1	2.3 to 4.8	0.95 to 10.0	0.1							200	—	Yes	SSOP5	YES
BD46Exx5G-M series	0.1V step 26 type	±1	2.3 to 4.8	0.95 to 10.0	0.1							50	—	Yes	SSOP5	YES
BD46Exx1G-M series	0.1V step 26 type	±1	2.3 to 4.8	0.95 to 10.0	0.1							100	—	Yes	SSOP5	YES
BD46Exx2G-M series	0.1V step 26 type	±1	2.3 to 4.8	0.95 to 10.0	0.1							200	—	Yes	SSOP5	YES
New BD52xxG-2M series	0.1V step 42 type	±2.5 (All Temperature)	0.9 to 5.0	0.8 to 6.0	0.1	Open drain	0.23	0.27	V _{DET} ×0.05	1.0mA or more	2.0mA or more	Variable	±30% (All Temperature)	No	SSOP5	YES
New BD53xxG-2M series	0.1V step 42 type	±2.5 (All Temperature)	0.9 to 5.0	0.8 to 6.0	0.1	CMOS						Variable	±30% (All Temperature)	No	SSOP5	YES

125°C Corresponding																
Part No.	Types	Voltage Detection Precision Within The Full Temperature Range (%)	Voltage Detection (V)	RESET Active Voltage Range (V)	Detection step(V)	Output Type	Circuit current(μA)		Hysteresis Voltage (V)	*L*Output current (mA)		RESET Active Timeout Period(ms)	Delay Time Precision (%)	Manual Reset PIN	Package	Automotive Grade AEC-Q100
							ON	OFF		V _{DD} =1.2V	V _{DD} =2.4V					
BD52xxG-2C series	0.1V step 42 type	±3	0.9 to 5.0	0.8 to 6.0	0.1	Open drain	0.23	0.27	V _{DET} ×0.05	1.0mA or more	2.0mA or more	Variable	±50 (All Temperature)	No	SSOP5	YES
BD53xxG-2C series	0.1V step 42 type	±3	0.9 to 5.0	0.8 to 6.0	0.1	CMOS						Variable	±50 (All Temperature)	No	SSOP5	YES

Voltage Detectors for Automotive : Detection voltage is applied in the "xx" of part No.. Ex. : In case of 2.3V detection voltage in BD48ExxG-M series, Part No. is BD48E23G-M.

Others

Voltage Detectors with Watchdog Timer														
Part No.	Voltage Detection Precision (%)	Voltage Detection (V)	RESET Active Voltage Range (V)	Output Type	Circuit Current(μA)		Hysteresis Voltage (V)	*L*Output Current(mA)		RESET Active Timeout Period (ms)	Delay Circuit Resistance (MΩ)	WDT Active Voltage Range (V)	INH Mode (Active)	Package
					ON	OFF		V _{DD} =1.2V	V _{DD} =0.5V					
BD37A19FVM	±1.5	1.9	1.0 to 10.0	Open Drain	5	V _{DET} ×0.13	0.7	Variable	10	2.5 to 10.0	H	MSOP8		
BD37A41FVM	±1.5	4.1	1.0 to 10.0	Open Drain	5	V _{DET} ×0.035	0.7	Variable	10	2.5 to 10.0	H	MSOP8		
BD87A28FVM	±1.5	2.8	1.0 to 10.0	Open Drain	5	V _{DET} ×0.045	0.7	Variable	10	2.5 to 10.0	L	MSOP8		
BD87A29FVM	±1.5	2.9	1.0 to 10.0	Open Drain	5	V _{DET} ×0.05	0.7	Variable	10	2.5 to 10.0	L	MSOP8		
BD87A34FVM	±1.5	3.4	1.0 to 10.0	Open Drain	5	V _{DET} ×0.05	0.7	Variable	10	2.5 to 10.0	L	MSOP8		
BD87A41FVM	±1.5	4.1	1.0 to 10.0	Open Drain	5	V _{DET} ×0.035	0.7	Variable	10	2.5 to 10.0	L	MSOP8		
BD99A41F	±1.5	4.1	1.0 to 10.0	Open Drain	5	V _{DET} ×0.035	0.7	Variable	10	2.5 to 10.0	H	SOP8		

Composite type Voltage Detectors(2ch+Comparator)								
Part No.	Voltage Detection Precision (%)	Voltage Detection (V)	Output Type	Circuit Current (μA) V _{SB} =5V	Hysteresis Voltage (mV)	RESET Active Timeout Period (ms)	Input Voltage (V)	Package
New BD3775AF	±1.5	1.23	Open Collector+ Constant Current Pull Up	350	28	Variable	3.5 to 18	SOP8



Motor / Actuator Drivers

CONTENTS

DC Brush Motor Drivers P. A68

- 7V Max. H-Bridge Drivers P. A68
- 18V Max. H-Bridge Drivers P. A68
- 36V Max. H-Bridge Drivers P. A68
- 40/60V Max. H-Bridge Drivers P. A68
- H-Bridge Drivers High-Current Series P. A68
- H-Bridge Drivers High-Speed Series P. A68
- 1.0A Reversible Motor Drivers(Single Motor) P. A68
- 2.0A or More Reversible Motor Driver(Single Motor) P. A69
- 1.0A or More Reversible Motor Driver(2 Motors) P. A69

Stepper Motor Drivers P. A69

- High Performance, High Reliability 36V Stepper Motor Drivers P. A69
- Standard 36V Stepper Motor Drivers P. A70
- Microstep 36V Stepper Motor Drivers P. A70
- Low Voltage Stepper Motor Drivers P. A70
- 45V Stepper Motor Drivers P. A71

3-Phase Brushless Motor Drivers P. A71

- 3-Phase Brushless Motor Pre-Driver with Speed Control P. A71
- 3-Phase Brushless Motor Driver with Speed Control P. A71
- 3-Phase Brushless Motor Pre-Drivers P. A71
- 3-Phase Brushless Motor Drivers P. A71

Fan Motor Drivers P. A72

- 5V Single-Phase Full-wave Fan Motor Drivers P. A72
- Standard Single-Phase Full-wave Fan Motor Drivers P. A72
- Multifunction Single-Phase Full-wave Fan Motor Drivers P. A73
- 2-Phase Half-wave Fan Motor Drivers P. A73
- 3-Phase Full-wave Fan Motor Drivers P. A73
- 3-Phase Brushless Fan Motor Drivers P. A74
- 3-Phase Brushless Fan Motor Controllers P. A74

Driver for ODD P. A74

- 1ch System Motor Driver ICs P. A74
- 2ch to 3ch System Motor Driver IC P. A74
- 4ch System Motor Driver ICs P. A74
- 5ch System Motor Driver ICs P. A74
- 6ch to 9ch System Motor Driver ICs P. A75
- System Motor Driver ICs for Half Height Drives(Sensorless) P. A75
- System Motor Driver ICs for Slim Drives(3 sensors) P. A75

Drivers for Printer P. A75

- 3-Phase Brushless Motor Driver for Polygonal Mirrors P. A75
- Motor Drivers with Brush for Printers P. A75
- Bipolar Stepper Motor Drivers for Paper Feed/Carriage P. A75
- 3-Phase Brushless Motor Pre-Drivers for Paper Feed P. A75

Driver for Digital Still Camera P. A76

- 5ch System Lens Drivers for Digital Still Cameras P. A76
- 6ch System Lens Drivers for Digital Still Cameras P. A76
- 7ch System Lens Drivers for Digital Still Cameras P. A76
- Single- and Dual-Channel Lens Drivers for SLRs(Single Lens Reflex) P. A76
- Microstep System Lens Drivers for Digital Cameras P. A77

Mobile Phone Module Drivers P. A78

- Parallel Interface Lens Driver for Voice Coil Motors P. A78
- 2-wire Serial (I²C-compatible) Interface Lens Drivers for Uni-directional Voice Coil Motors P. A78
- 2-wire Serial (I²C-compatible) Interface Lens Drivers for Bi-directional Voice Coil Motors P. A78
- 2-wire Serial (I²C-compatible) Interface Lens Driver for Piezo Actuators P. A78
- Parallel Interface Lens Driver for Stepping Motors P. A78

DC Brush Motor Drivers

7V Max. H-Bridge Drivers

Part No.	ch	Supply Voltage (V)	Output Current (A)	Input Threshold Voltage		Output ON Resistance(Ω Typ.)	Output Modes	Package
				H Level(V)	L Level(V)			
BD6210F	1	3.0 to 5.5	0.5	2.0 or more	0.8 or less	1.0	Forward/Reverse/Standby(Idler)/Brake	SOP8
BD6210HFP			HRP7					
BD6211F			1.0					SOP8
BD6211HFP			1.0					HRP7
BD6212FP			2.0					HSOP25
BD6212HFP			2.0					HRP7

18V Max. H-Bridge Drivers

BD6220F	1	6.0 to 15.0	0.5	2.0 or more	0.8 or less	1.5	Forward/Reverse/Standby(Idler)/Brake	SOP8		
BD6221F			1.0					SOP8		
BD6222FP			2.0					HSOP25		
BD6222HFP			2.0					HRP7		
BD6225FP			2					0.5	1.5	HSOP25
BD6226FP								1.0	1.5	HSOP25

36V Max. H-Bridge Drivers

BD6230F	1	6.0 to 32.0	0.5	2.0 or more	0.8 or less	1.5	Forward/Reverse/Standby(Idler)/Brake	SOP8
BD6231F			1.0					SOP8
BD6231HFP			2.0					HRP7
BD6232FP			2.0					HSOP25
BD6232HFP			2.0					HRP7
BD6236FP			2					1.0
BD6236FM	2.0	1.0		HSOP-M28				
BD6237FM	2.0	1.0		HSOP-M28				
BD62110AEFJ	1	8.0 to 28.0		1.0	1.8	HTSOP-J8		

40V/60V Max. H-Bridge Drivers

Part No.	Maximum Voltage (V)	Supply Voltage (V)	Output Current (A)	ch	Output ON Resistance (upper + lower)(Ω Typ.)	Output Modes	Operating Temperature (°C)	Package	Automotive Grade	AEC-Q100
BD16933EFV-C	60	7.0 to 36.0	1	1.5	1.81	Available to select High, Low or Hi-Z Output by each Output terminal.	-40 to +125	HTSSOP-B20	YES	YES
BD16922EFV-M	60	8.0 to 36.0	1	2	2.25	Forward / Reverse / Standby / Brake	-40 to +110	HTSSOP-B24	YES	YES
BD16936EFV-M	60	8.0 to 36.0	1	3	2.1	Available to select High, Low or Hi-Z Output by each Output terminal.	-40 to +110	HTSSOP-B28	YES	YES
New BD16950EFV-C	40	5.5 to 40	-	1	-	Available to select High, Low or Hi-Z Output by each Output terminal.	-40 ~ +125	HTSSOP-B24	YES	YES
New BD16938EFV-C	40	6.3 to 32	-	4	1.4	Available to select High, Low or Hi-Z Output by each Output terminal.	-40 ~ +125	HTSSOP-B28	YES	YES

H-Bridge Drivers High-Current Series

Part No.	ch	Supply Voltage (V)	Output Current (A)	Input Threshold Voltage		Output ON Resistance(Ω Typ.)	Output Modes	Package
				H Level(V)	L Level(V)			
BD62222HFP	1	6.0 to 27.0	2.5	2.0 or more	0.8 or less	1.0	Forward/Reverse/Standby(Idler)/Brake	HRP7
BD62321HFP		6.0 to 32.0	3.0					

H-Bridge Drivers High-Speed Series

BD65491FV	1	1.8 to 16.0	1.2 peak4.0	1.45 or more	0.5 or less	0.35	Forward/Reverse/Standby(Idler)/Brake	SSOP-B16
BD65492MUV	2	1.8 to 16.0	1.0	1.45 or more	0.5 or less	0.9	Forward/Reverse/Standby(Idler)/Brake	VQFN024V4040
BD65494MUV	1	2.0 to 9.0	1.0 peak2.5	2.0 or more	0.7 or less	0.55	Forward/Reverse/Standby(Idler)/Brake	VQFN016V3030
BD65496MUV	1	1.8 to 16.0	1.2 peak5.0	1.45 or more	0.5 or less	0.35	Forward/Reverse/Standby(Idler)/Brake	VQFN024V4040
BD6376GUL	1	2.0 to 9.0	1.0	2.0 or more	0.7 or less	0.45	Forward/Reverse/Standby(Idler)/Brake	VCSP50L1
BD6736FV	1	2.0 to 9.0	1.0 peak3.2	2.0 or more	0.7 or less	0.35	Forward/Reverse/Standby(Idler)/Brake	SSOP-B20
BD6735FV	2	2.0 to 8.0	1.0	2.0 or more	0.7 or less	1.0	Forward/Reverse/Standby(Idler)/Brake	SSOP-B20
New BD63565EFV	2	1.8 to 16.0	1.0	1.45 or more	0.5 or less	0.9	Forward/Reverse/Standby(Idler)/Brake	HTSSOP-B20
New BD63573NUV	1	2.0 to 16.0	1.2 peak3.2	1.45 or more	0.5 or less	0.38	Forward/Reverse/Standby(Idler)/Brake	VSON010V3030

1.0A Reversible Motor Drivers(Single Motor)

Part No.	Supply Voltage (V)	Output Current (A)	Input Threshold Voltage		Output Saturation Voltage (V Typ.)	Output Modes	Package
			H Level(V)	L Level(V)			
BA6287F	4.5 to 15	1.0	2.0 or more	0.8 or less	1.0 (I _o =0.2A)	Forward/Reverse/Idler/Brake	SOP8
BA6285FS	4.5 to 15	1.0	2.0 or more	0.8 or less	1.0 (I _o =0.2A)	Forward/Reverse/Idler/Brake	SSOP-A16
BA6285AFP-Y	4.5 to 24	1.0	2.0 or more	0.8 or less	1.0 (I _o =0.2A)	Forward/Reverse/Idler/Brake	HSOP25
BA6920FP-Y	6.5 to 34	1.0	3.0 or more	0.8 or less	2.2 (I _o =0.02A)	Forward/Reverse/Idler/Brake	HSOP25

- ▶ DC Brush Motor Drivers ▶▶ 2.0A or More Reversible Motor Driver(Single Motor)
 - ▶▶ 1.0A or More Reversible Motor Driver(2 Motors)
- ▶ Stepper Motor Drivers ▶▶ High Performance, High Reliability 36V Stepper Motor Drivers

2.0A or More Reversible Motor Driver(Single Motor)							
Part No.	Supply Voltage (V)	Output Current (A)	Input Threshold Voltage		Output Saturation Voltage (V Typ.)	Output Modes	Package
			H Level(V)	L Level(V)			
BA6219BFP-Y	8 to 18	2.2	3.0 or more	1.0 or less	2.4 (I _o =0.4A)	Forward/Reverse/Idle/Brake	HSOP25
1.0A or More Reversible Motor Driver(2 Motors)							
BA6247FP-Y	8 to 18	1.0	3.5 or more	1.0 or less	2.4 (I _o =0.5A)	Forward/Reverse/Brake	HSOP25

Stepper Motor Drivers

High Performance, High Reliability 36V Stepper Motor Drivers For PPCs, MFPs, Industrial equipments etc.

BD63730EFV	CLK IN	PARA IN	Iomax 3.0A	UNSTEP	Constant Current PWM	FWRW	DECAY SW	Thin PKG	Small Power Package	FUNCTION COMPATIBLE	5-PIN UNIVERSAL	ONE POWER	T.S.D.	O.C.P.	UV	OVL	4kV	ESD	Short Protection	Protection
BD6387EFV	CLK IN	PARA IN	Iomax 2.0A	UNSTEP	Constant Current PWM	FWRW	DECAY SW	Thin PKG	Small Power Package	FUNCTION COMPATIBLE	5-PIN UNIVERSAL	ONE POWER	T.S.D.	O.C.P.	UV	OVL	6kV	ESD	Short Protection	Protection
BD6385EFV	CLK IN	PARA IN	Iomax 1.5A	UNSTEP	Constant Current PWM	FWRW	DECAY SW	Thin PKG	Small Power Package	FUNCTION COMPATIBLE	5-PIN UNIVERSAL	ONE POWER	T.S.D.	O.C.P.	UV	OVL	6kV	ESD	Short Protection	Protection
BD6383EFV	CLK IN	PARA IN	Iomax 1.0A	UNSTEP	Constant Current PWM	FWRW	DECAY SW	Thin PKG	Small Power Package	FUNCTION COMPATIBLE	5-PIN UNIVERSAL	ONE POWER	T.S.D.	O.C.P.	UV	OVL	6kV	ESD	Short Protection	Protection
BD6389FM	CLK IN	PARA IN	Iomax 2.2A	UNSTEP	Constant Current PWM	FWRW	DECAY SW	Thin PKG	Small Power Package	FUNCTION COMPATIBLE	5-PIN UNIVERSAL	ONE POWER	T.S.D.	O.C.P.	UV	OVL	6kV	ESD	Short Protection	Protection
BD68720EFV	PARA IN	CLK IN	Iomax 2.0A	UNSTEP	Constant Current PWM	FWRW	DECAY SW	Thin PKG	Small Power Package	FUNCTION COMPATIBLE	5-PIN UNIVERSAL	ONE POWER	T.S.D.	O.C.P.	UV	OVL	6kV	ESD	Short Protection	Protection
BD68715EFV	PARA IN	CLK IN	Iomax 1.5A	UNSTEP	Constant Current PWM	FWRW	DECAY SW	Thin PKG	Small Power Package	FUNCTION COMPATIBLE	5-PIN UNIVERSAL	ONE POWER	T.S.D.	O.C.P.	UV	OVL	6kV	ESD	Short Protection	Protection
BD68710EFV	PARA IN	CLK IN	Iomax 1.0A	UNSTEP	Constant Current PWM	FWRW	DECAY SW	Thin PKG	Small Power Package	FUNCTION COMPATIBLE	5-PIN UNIVERSAL	ONE POWER	T.S.D.	O.C.P.	UV	OVL	6kV	ESD	Short Protection	Protection
BD63725BEFV	CLK IN	PARA IN	Iomax 2.5A	UNSTEP	Constant Current PWM	FWRW	DECAY SW	Thin PKG	Small Power Package	FUNCTION COMPATIBLE	5-PIN UNIVERSAL	ONE POWER	T.S.D.	O.C.P.	UV	OVL	6kV	ESD	Short Protection	Protection
BD63720AEFV	CLK IN	PARA IN	Iomax 2.0A	UNSTEP	Constant Current PWM	FWRW	DECAY SW	Thin PKG	Small Power Package	FUNCTION COMPATIBLE	5-PIN UNIVERSAL	ONE POWER	T.S.D.	O.C.P.	UV	OVL	6kV	ESD	Short Protection	Protection
BD63715AEFV	CLK IN	PARA IN	Iomax 1.5A	UNSTEP	Constant Current PWM	FWRW	DECAY SW	Thin PKG	Small Power Package	FUNCTION COMPATIBLE	5-PIN UNIVERSAL	ONE POWER	T.S.D.	O.C.P.	UV	OVL	6kV	ESD	Short Protection	Protection
BD63710AEFV	CLK IN	PARA IN	Iomax 1.0A	UNSTEP	Constant Current PWM	FWRW	DECAY SW	Thin PKG	Small Power Package	FUNCTION COMPATIBLE	5-PIN UNIVERSAL	ONE POWER	T.S.D.	O.C.P.	UV	OVL	6kV	ESD	Short Protection	Protection
BD63910MUV	CLK IN	PARA IN	Iomax 1.0A	UNSTEP	Constant Current PWM	FWRW	DECAY SW	Thin PKG	Small Power Package	FUNCTION COMPATIBLE	5-PIN UNIVERSAL	ONE POWER	T.S.D.	O.C.P.	UV	OVL	6kV	ESD	Short Protection	Protection
BD63920MUV	CLK IN	PARA IN	Iomax 2.0A	UNSTEP	Constant Current PWM	FWRW	DECAY SW	Thin PKG	Small Power Package	FUNCTION COMPATIBLE	5-PIN UNIVERSAL	ONE POWER	T.S.D.	O.C.P.	UV	OVL	6kV	ESD	Short Protection	Protection

* 1 The BD6387EFV, BD6385EFV, BD6383EFV, and BD6389FM are all function-compatible. * 2 The BD6387EFV, BD6385EFV, and BD6383EFV are all pin-compatible.
 * 3 The BD63876EFV, BD63874EFV, and BD63872EFV are all function-compatible. * 4 The BD63876EFV, BD63874EFV, and BD63872EFV are all pin-compatible.
 * 5 The BD63720AEFV, BD63715AEFV, and BD63710AEFV are all function-compatible. * 6 The BD63720AEFV, BD63715AEFV, and BD63710AEFV are all pin-compatible.

Part No.	Supply Voltage(V)	Output Current (A)	Circuit Current (mA)	Input Threshold Voltage		Output ON Resistance (Ω)	Package
	V _{CC}			High Level Voltage(V)	Low Level Voltage(V)		
BD63730EFV	19 to 28	3.0	2.0	2.0	0.8	0.4	HTSSOP-B54
BD6387EFV	10 to 28	2.0	4.5	2.0	0.8	0.8	HTSSOP-B40
BD6385EFV	10 to 28	1.5	4.5	2.0	0.8	1.0	HTSSOP-B40
BD6383EFV	10 to 28	1.0	4.5	2.0	0.8	1.5	HTSSOP-B40
BD6389FM	10 to 28	2.2	4.5	2.0	0.8	0.7	HSOP-M36
BD68720EFV	19 to 28	2.0	2.0	2.0	0.8	0.65	HTSSOP-B28
BD68715EFV	19 to 28	1.5	2.0	2.0	0.8	0.95	HTSSOP-B28
BD68710EFV	19 to 28	1.0	2.0	2.0	0.8	1.2	HTSSOP-B28
BD63725BEFV	8 to 28	2.5	2.0	2.0	0.8	0.35	HTSSOP-B28
BD63720AEFV	19 to 28	2.0	2.0	2.0	0.8	0.65	HTSSOP-B28
BD63715AEFV	19 to 28	1.5	2.0	2.0	0.8	0.95	HTSSOP-B28
BD63710AEFV	19 to 28	1.0	2.0	2.0	0.8	1.2	HTSSOP-B28
New BD63910MUV	8 to 28	1.0	2.5	2.0	0.8	1.3	VQFN028V5050
New BD63920MUV	8 to 28	2.0	2.5	2.0	0.8	0.49	VQFN028V5050

Symbol Key	CLK Control signal input CLK-IN type	PARA Control signal input PARALLEL-IN type	Iomax 1.0A Maximum output current	Iomax 1.5A	Iomax 2.0A	Iomax 2.2A	Iomax 2.5A	Iomax 3.0A	UNSTEP Number of step	Constant Current PWM Constant-current PWM	FWRW Switch able between forward and reverse	ONE POWER 1 power supply system due to built-in regulator	T.S.D. Built-in thermal shut-down circuit
DECAY SW SLOW/FAST/MIX DECA switching function	Thin PKG Thin package	Small Power Package Small power package	FUNCTION COMPATIBLE Function-compatible	5-PIN UNIVERSAL Easy replacement pin compatible with competitor's	UV Built-in under voltage lock out circuit	OVL Built-in over voltage lock out circuit	4kV 6kV ESD resistance	Short Protection Adjacent pin short protection	Inverse mounting Protection Inverse mounting protection				

Standard 36V Stepper Motor Drivers

BD6395FP	PARAMETER I _{max} 1.5A 12STEP	FUNCTION CURRENT PWM SERVO SW ONE POWER T.S.D. O.C.P. UV OVLO 4kV FUNCTION COMPATIBLE SERVO 40-185V
BD6393FP	PARAMETER I _{max} 1.2A 12STEP	FUNCTION CURRENT PWM SERVO SW ONE POWER T.S.D. O.C.P. UV OVLO 4kV FUNCTION COMPATIBLE SERVO 40-185V
BD68620EFV	PARAMETER I _{max} 2.0A 12STEP	FUNCTION CURRENT PWM THIN PKG SERVO SW ONE POWER T.S.D. O.C.P. UV OVLO FUNCTION COMPATIBLE SERVO 40-185V
BD68610EFV	PARAMETER I _{max} 1.0A 12STEP	FUNCTION CURRENT PWM THIN PKG SERVO SW ONE POWER T.S.D. O.C.P. UV OVLO FUNCTION COMPATIBLE SERVO 40-185V
BD6290EFV	PARAMETER I _{max} 0.8A 12STEP	FUNCTION CURRENT PWM THIN PKG SERVO SW ONE POWER T.S.D. O.C.P. UV OVLO 4kV FUNCTION COMPATIBLE SERVO 40-185V
BD63960EFV	PARAMETER I _{max} 1.5A 12STEP	FUNCTION CURRENT PWM THIN PKG SERVO SW ONE POWER T.S.D. O.C.P. UV OVLO 4kV SHORT PROTECTION FUNCTION COMPATIBLE SERVO 40-185V
BD63940EFV	PARAMETER I _{max} 1.2A 12STEP	FUNCTION CURRENT PWM THIN PKG SERVO SW ONE POWER T.S.D. O.C.P. UV OVLO 4kV SHORT PROTECTION FUNCTION COMPATIBLE SERVO 40-185V
BD63620AEFV	CLK I _{max} 2.0A 12STEP	FUNCTION CURRENT PWM THIN PKG SERVO SW ONE POWER T.S.D. O.C.P. UV OVLO SHORT PROTECTION FUNCTION COMPATIBLE SERVO 40-185V
BD63610AEFV	CLK I _{max} 1.0A 12STEP	FUNCTION CURRENT PWM THIN PKG SERVO SW ONE POWER T.S.D. O.C.P. UV OVLO SHORT PROTECTION FUNCTION COMPATIBLE SERVO 40-185V
BD63801EFV	CLK I _{max} 0.8A 12STEP	FUNCTION CURRENT PWM THIN PKG SERVO SW ONE POWER T.S.D. O.C.P. UV OVLO 4kV SHORT PROTECTION FUNCTION COMPATIBLE SERVO 40-185V

*1 The BD6395FP, BD6393FP, and BD6290EFV are all function-compatible. *2 The BD6395FP and BD6393FP are all pin-compatible.
 *3 The BD63620AEFV, BD63610AEFV, and BD63801EFV are all function-compatible. *4 The BD63960EFV and BD63940EFV are all pin-compatible.

Part No.	Supply Voltage(V)		Output Current (A)	Circuit Current (mA)	Input Threshold Voltage		Output ON Resistance (Ω)	Package
	V _{cc}	V _m			High Level Voltage(V)	Low Level Voltage(V)		
BD6395FP	16 to 28		1.5	3.0	2.0	0.8	1.2	HSOP25
BD6393FP	16 to 28		1.2	3.0	2.0	0.8	1.5	HSOP25
BD68620EFV	19 to 28		2.0	1.3	2.0	0.8	0.95	HTSSOP-B24
BD68610EFV	19 to 28		1.0	1.3	2.0	0.8	1.8	HTSSOP-B20
BD6290EFV	19 to 28		0.8	3.0	2.0	0.8	2.8	HTSSOP-B24
BD63960EFV	19 to 28		1.5	2.7	2.0	0.8	1.1	HTSSOP-B24
BD63940EFV	19 to 28		1.2	2.7	2.0	0.8	1.4	HTSSOP-B24
BD63620AEFV	19 to 28		2.0	1.3	2.0	0.8	0.95	HTSSOP-B24
BD63610AEFV	19 to 28		1.0	1.3	2.0	0.8	1.8	HTSSOP-B20
BD63801EFV	19 to 28		0.8	2.7	2.0	0.8	2.8	HTSSOP-B24

Microstep 36V Stepper Motor Drivers

BD63860EFV	CLK I _{max} 2.5A 12STEP	FUNCTION CURRENT PWM SERVO SW THIN PKG SERVO SW ONE POWER T.S.D. O.C.P. UV OVLO
BD63847EFV	CLK I _{max} 2.0A 12STEP	FUNCTION CURRENT PWM SERVO SW THIN PKG SERVO SW FUNCTION COMPATIBLE SERVO ONE POWER T.S.D. O.C.P. UV OVLO
BD63843EFV	CLK I _{max} 1.0A 12STEP	FUNCTION CURRENT PWM SERVO SW THIN PKG SERVO SW FUNCTION COMPATIBLE SERVO ONE POWER T.S.D. O.C.P. UV OVLO
BD63510AEFV	CLK I _{max} 1.0A 12STEP	FUNCTION CURRENT PWM SERVO SW THIN PKG SERVO SW FUNCTION COMPATIBLE SERVO ONE POWER T.S.D. O.C.P. UV OVLO
BD63511EFV	CLK I _{max} 1.0A 12STEP	FUNCTION CURRENT PWM SERVO SW THIN PKG SERVO SW FUNCTION COMPATIBLE SERVO ONE POWER T.S.D. O.C.P. UV OVLO
BD63520AEFV	CLK I _{max} 2.0A 12STEP	FUNCTION CURRENT PWM SERVO SW THIN PKG SERVO SW FUNCTION COMPATIBLE SERVO ONE POWER T.S.D. O.C.P. UV OVLO
BD63521EFV	CLK I _{max} 2.0A 12STEP	FUNCTION CURRENT PWM SERVO SW THIN PKG SERVO SW FUNCTION COMPATIBLE SERVO ONE POWER T.S.D. O.C.P. UV OVLO
BD63524AEFV	CLK I _{max} 2.5A 12STEP	FUNCTION CURRENT PWM SERVO SW THIN PKG SERVO SW FUNCTION COMPATIBLE SERVO ONE POWER T.S.D. O.C.P. UV OVLO
BD63525AEFV	CLK I _{max} 2.5A 12STEP	FUNCTION CURRENT PWM SERVO SW THIN PKG SERVO SW FUNCTION COMPATIBLE SERVO ONE POWER T.S.D. O.C.P. UV OVLO

*1 The BD63847EFV and BD63843EFV are all function-compatible. *2 The BD63510AEFV, BD63520AEFV and BD63525AEFV are all function-compatible.
 *3 The BD63511AEFV and BD63521AEFV are all function-compatible.

Part No.	Supply Voltage(V)		Output Current (A)	Circuit Current (mA)	Input Threshold Voltage		Output ON Resistance (Ω)	Package
	V _{cc}	V _m			High Level Voltage(V)	Low Level Voltage(V)		
BD63860EFV	16 to 28		2.5	4.0	2.0	0.8	0.8	HTSSOP-B28
BD63847EFV	19 to 28		2.0	2.5	2.0	0.8	0.85	HTSSOP-B28
BD63843EFV	19 to 28		1.0	2.5	2.0	0.8	1.9	HTSSOP-B28
New BD63510AEFV	8 to 28		1.0	2.5	2.0	0.8	1.75	HTSSOP-B28
New BD63511EFV	8 to 28		1.0	2.5	2.0	0.8	1.75	HTSSOP-B28
New BD63520AEFV	8 to 28		2.0	2.5	2.0	0.8	0.65	HTSSOP-B28
New BD63521EFV	8 to 28		2.0	2.5	2.0	0.8	0.65	HTSSOP-B28
New BD63524AEFV	8 to 28		2.5	2.5	2.0	0.8	0.35	HTSSOP-B28
New BD63525AEFV	8 to 28		2.5	2.5	2.0	0.8	0.35	HTSSOP-B28

Low Voltage Stepper Motor Drivers for Mini and Handheld Printers

BD6382EFV	PARAMETER I _{max} 0.8A 12STEP	FUNCTION CURRENT PWM SERVO SW THIN PKG SERVO SW ONE POWER T.S.D. O.C.P. UV OVLO SHORT PROTECTION FUNCTION COMPATIBLE SERVO 40-185V
BD6381EFV	PARAMETER I _{max} 1.2A 12STEP	FUNCTION CURRENT PWM SERVO SW THIN PKG SERVO SW ONE POWER T.S.D. O.C.P. UV OVLO SHORT PROTECTION FUNCTION COMPATIBLE SERVO 40-185V
BD6380EFV	PARAMETER I _{max} 0.8A 12STEP	FUNCTION CURRENT PWM SERVO SW THIN PKG SERVO SW ONE POWER T.S.D. O.C.P. UV OVLO SHORT PROTECTION FUNCTION COMPATIBLE SERVO 40-185V

Part No.	Supply Voltage(V)		Output Current (A)	Circuit Current (mA)	Input Threshold Voltage		Output ON Resistance (Ω)	Package
	V _{cc}	V _m			High Level Voltage(V)	Low Level Voltage(V)		
BD6382EFV	3.0 to 5.5	5.5 to 13.5	0.8	1.6	2.0	0.8	1.2	HTSSOP-B24
BD6381EFV	2.5 to 5.5	6.0 to 13.5	1.2	1.6	2.0	0.8	1.0	HTSSOP-B24
BD6380EFV	2.5 to 5.5	4.0 to 13.5	0.8	1.6	2.0	0.8	1.2	HTSSOP-B24

Symbol Key

- CLK: Control signal input CLK-IN type
- PARAMETER: Control signal input PARALLEL-IN type
- I_{max} 0.8A, 1.0A, 1.2A, 1.5A, 2.0A, 2.5A: Maximum output current
- 12STEP, 18STEP, 1/8STEP, 1/16STEP: Number of step
- 36V MAX, 60V MAX: Voltage resistance
- SERVO: Built-in servo circuit
- 120° PWM, 180° PWM: Output power system
- ONE POWER: 1 power supply system due to built-in regulator
- T.S.D.: Built-in thermal shut-down circuit
- O.C.P.: Built-in over current protection circuit
- FUNCTION COMPATIBLE: Function-compatible
- UV LO: Built-in under voltage lock out circuit
- SWITCHABLE: Switch able between forward and reverse
- SMALL POWER: Small power package
- DECAV SW: SLOW/FAST/MIX DECAV switching function

45V Stepper Motor Drivers

BD6425EFV

BD6423EFV

BD6422EFV

Part No.	Supply Voltage(V)	Output Current (A)	Circuit Current (mA)	Input Threshold Voltage		Output ON Resistance (Ω)	Package
	V _{cc}			High Level Voltage(V)	Low Level Voltage(V)		
BD6425EFV	19 to 42	1.5	2.0	2.0	0.8	1.1	HTSSOP-B28
BD6423EFV	19 to 42	1.0	2.0	2.0	0.8	2.0	HTSSOP-B24
BD6422EFV	19 to 42	1.0	2.0	2.0	0.8	2.0	HTSSOP-B24

3-Phase Brushless Motor Drivers

3-Phase Brushless Motor Pre-Driver with Speed Control

BD6762FV

Part No.	Max. Voltage (V)	Supply Voltage (V)	Operating Temperature (°C)	Circuit Current (mA)	Input Threshold Voltage		External FET Drive Voltage		PWM Frequency (kHz)	Package
					H Level(V)	L Level(V)	Upper(V)	Lower(V)		
BD6762FV	36	16.0 to 28.0	-25 to +75	17.0	2.2	0.8	V _{cc} +6.8	10.8	16	SSOP-B40

3-Phase Brushless Motor Driver with Speed Control

BD67929EFV

Part No.	Max. Voltage (V)	Supply Voltage (V)	Operating Temperature (°C)	Circuit Current (mA)	Input Threshold Voltage		External FET Drive Voltage		PWM Frequency (kHz)	Package
					H Level(V)	L Level(V)	Upper(V)	Lower(V)		
BD67929EFV	36	19 to 28	-25 to +85	4.0	3.0	1.5	-	-	200	HTSSOP-B28

3-Phase Brushless Motor Pre-Drivers

BD6761FS

BD63001AMUV

BD63002AMUV

BD16805FV-M

Part No.	Max. Voltage (V)	Supply Voltage (V)	Operating Temperature (°C)	Circuit Current (mA)	Input Threshold Voltage		External FET Drive Voltage		PWM Frequency (kHz)	Package	Automotive Grade AEC-Q100
					H Level(V)	L Level(V)	Upper(V)	Lower(V)			
BD6761FS	36	16.0 to 28.0	-35 to +75	15.0	2.2	0.8	V _{cc} +6	10.5	15	SSOP-A32	
BD63001AMUV	33	4.5 to 5.5, 6.0 to 28	-40 to +85	2.5	2.0	0.8	V _{cc} -0.2	9.5	20	VQFN024V4040	
BD63002AMUV	30	8.0 to 26.4	-40 to +85	2.5	2.0	0.8	V _{cc} +7	5	External IN	VQFN028V5050	
Part No.	Max. Voltage (V)	Supply Voltage (V)	Operating Temperature (°C)	Circuit Current (mA)	Input Threshold Voltage		External FET Drive Voltage V _{cc} =8V		PWM Frequency (kHz)	Package	Automotive Grade AEC-Q100
BD16805FV-M	60	8 to 18	-40 to +110	15.2	H Level(V)	L Level(V)	Upper(V)	Lower(V)			

3-Phase Brushless Motor Drivers

BD63005AMUV

BD63006MUV

BD63007MUV

BD63035EFV-M

Part No.	Max. Voltage (V)	Supply Voltage (V)	Output Current (A)	Operating Temperature (°C)	Circuit Current (mA)	Input Threshold Voltage		Output ON Resistance (Ω)	Package	
						H Level(V)	L Level(V)			
BD63005AMUV	33	10 to 28	2.0	-25 to +85	4.4	2	0.8	0.17	VQFN040V6060	
BD63006MUV	33	8 to 28	1.5	-40 to +85	4.4	-	-	0.8	VQFN024V4040	
BD63007MUV	33	8 to 28	3.0	-25 to +85	4.4	2	0.8	0.17	VQFN040V6060	
Part No.	Max. Voltage (V)	Supply Voltage (V)	Operating Temperature (°C)	Circuit Current (mA)	Input Threshold Voltage		Output ON Resistance (Ω)	PWM Frequency (kHz)	Package	Automotive Grade AEC-Q100
BD63035EFV-M	36	8 to 28	-40 to +105	8	H Level(V)	L Level(V)	0.6			

New

Fan Motor Drivers

5V Single-Phase Full-wave Fan Motor Drivers

BH6766FVM						
BD6965NUX						
BD6966NUX						
BU6909AGFT						
BU69090NUX						

Part No.	Supply Voltage (V)	I _o Max. (mA)	Power Tr.	Output Saturation Voltage (V)	Speed Control	Hall Bias Voltage (V)	Lock Time Ratio	Package
BH6766FVM	2.0 to 6.0	630	CMOS	Upper and Lower 0.6(I _o =250mA)	—	1.3	—	MSOP8
BD6965NUX	2.0 to 5.5	800	CMOS	Upper and Lower 0.4(I _o =250mA)	Direct PWM	—	1 : 10	VSON008X2030
BD6966NUX	1.8 to 5.5	1,000	CMOS	Upper and Lower 0.4(I _o =300mA)	Direct PWM	1.0	1 : 10	VSON1010X3030
BU6909AGFT	1.8 to 5.5	800	CMOS	Upper and Lower 0.16(I _o =200mA)	Direct PWM	Include Hall sensor	1 : 10	TSSOF6
BU69090NUX	1.8 to 5.5	800	CMOS	Upper and Lower 0.16(I _o =200mA)	Direct PWM	Include Hall sensor	1 : 10	VSON008X2030

Standard Single-Phase Full-wave Fan Motor Drivers

BD6981FVM						
BD6982FVM						
BD6967FVM						
BD6968FVM						
BD6962FVM						
BD6964FVM						
BD6961F						
BD6964F						
BD69830FV						

Part No.	Supply Voltage (V)	I _o Max. (mA)	Power Tr.	Output Saturation Voltage (V)	Speed Control	Hall Bias Voltage (V)	Lock Time Ratio	Package
BD6981FVM	2.8 to 16.0	800	DMOS	Upper and Lower 0.45(I _o =200mA)	—	1.2	1 : 6	MSOP8
BD6982FVM	2.8 to 16.0	800	DMOS	Upper and Lower 0.45(I _o =200mA)	—	1.2	1 : 6	MSOP8
BD6967FVM	3.3 to 14.0	800	DMOS	Upper and Lower 0.45(I _o =200mA)	DC/Direct PWM	1.2	1 : 10	MSOP10
BD6968FVM	3.3 to 14.0	800	DMOS	Upper and Lower 0.45(I _o =200mA)	DC/Direct PWM	1.2	1 : 10	MSOP10
BD6962FVM	3.3 to 14.0	800	DMOS	Upper and Lower 0.4(I _o =300mA)	Direct PWM	—	1 : 10	MSOP8
BD6964FVM	3.3 to 14.0	800	DMOS	Upper and Lower 0.4(I _o =300mA)	Direct PWM	—	1 : 10	MSOP8
BD6961F	3.3 to 14.0	1,000	DMOS	Upper and Lower 0.4(I _o =300mA)	Direct PWM	—	1 : 10	SOP8
BD6964F	3.3 to 14.0	1,000	DMOS	Upper and Lower 0.4(I _o =300mA)	Direct PWM	—	1 : 10	SOP8
BD69830FV	6.0 to 28.0	900	DMOS	Upper and Lower 0.6(I _o =200mA)	Direct PWM	1.2	1 : 30	SSOP-B14

Symbol Key	5V Power supply compatible	12V Power supply compatible	24V Power supply compatible	250mA Class	300mA Class	350mA Class	400mA Class	450mA Class	800mA Class	PRE DRIVER	This is an indication for the amount of current that can flow into a motor running at fixed speed.	Include Hall Sensor	Small mount type	RPM pulse signal output	Soft switching	Built-in hall element power supply voltage	Rotational speed control possible	External capacitor for detecting motor lock not necessary	Lock alarm signal output
-------------------	----------------------------	-----------------------------	-----------------------------	-------------	-------------	-------------	-------------	-------------	-------------	------------	--	---------------------	------------------	-------------------------	----------------	--	-----------------------------------	---	--------------------------

Multifunction Single-Phase Full-wave Fan Motor Drivers

BD6971FV	12V MIN, 350 CLASS, Small Pkg	FG, FULL, SOFT S/W, HALL, LOCK, ALARM, MIN rpm, T.S.D., IO LIMIT
BD6994FV	12V MIN, 350 CLASS, Small Pkg	FG, FULL, SOFT S/W, HALL, LOCK, ALARM, MIN rpm, T.S.D.
BD6995FV	12V MIN, 400 CLASS, Small Pkg	FG, FULL, SOFT S/W, HALL, LOCK, ALARM, MIN rpm, T.S.D., IO LIMIT
BD61243FV	12V MIN, 450 CLASS, Small Pkg	FG, FULL, SOFT S/W, HALL, LOCK, ALARM, MIN rpm, T.S.D., IO LIMIT
BD69730FV	12V MIN, PRE DRIVER, Small Pkg	FG, FULL, SOFT S/W, HALL, LOCK, ALARM, MIN rpm, T.S.D., IO LIMIT, SOFT START
BD69740FV	12V MIN, PRE DRIVER, Small Pkg	SOFT S/W, HALL, LOCK, ALARM, MIN rpm, T.S.D., IO LIMIT, SOFT START
BD61245EFV	12V MIN, 800 CLASS, Small Pkg	FG, FULL, SOFT S/W, LOCK, ALARM, MIN rpm, T.S.D., IO LIMIT, SOFT START
BD61250MUV	12V MIN, PRE DRIVER, Small Pkg	FG, FULL, SOFT S/W, LOCK, ALARM, MIN rpm, T.S.D., IO LIMIT, SOFT START

Part No.	Supply Voltage (V)	Io Max. (mA)	Power Transistor	Output Saturation Voltage (V)	Speed Control	Hall Bias Voltage (V)	Lock Time Ratio	Package
BD6971FV	3.5 to 17.0	1,000	DMOS	Upper and Lower 0.6(Io=200mA)	DC/Direct PWM	1.3	1 : 10	SSOP-B14
BD6994FV	4.5 to 17.0	1,200	DMOS	Upper and Lower 0.6(Io=400mA)	DC/Direct PWM	1.25	1 : 10	SSOP-B16
BD6995FV	4.3 to 17.0	1,200	DMOS	Upper and Lower 0.6(Io=400mA)	DC	1.25	1 : 10	SSOP-B16
BD61243FV	5.5 to 16.0	1,200	DMOS	Upper and Lower 0.4(Io=400mA)	DC/Direct PWM	1.25	1 : 10	SSOP-B14
BD69730FV	4.3 to 17.0	10	Pre-Driver	—	DC/Direct PWM	1.26	1 : 20	SSOP-B16
BD69740FV	4.3 to 17.0	10	Pre-Driver	—	DC/Direct PWM	1.26	1 : 20	SSOP-B16
New BD61245EFV	4.0 to 16.0	1,800	DMOS	Upper and Lower 0.2(Io=400mA)	DC/Direct PWM	—	1 : 10	HTSSOP-B16
New BD61250MUV	4.5 to 36.0	10	Pre-Driver	—	DC/Direct PWM	—	1 : 20	VQFN024V4040

2-Phase Half-wave Fan Motor Drivers

BD6701F	24V MIN, 400 CLASS	FG, FULL, LOCK, ALARM, T.S.D., IO LIMIT
BA6406F	24V MIN, PRE DRIVER	LOCK, ALARM
BA6506F	24V MIN, PRE DRIVER	FG, FULL, LOCK
BA6901F	24V MIN, PRE DRIVER	FG, FULL, LOCK, ALARM, T.S.D., IO LIMIT

Part No.	Supply Voltage (V)	Io Max. (mA)	Power Transistor	Output Saturation Voltage (V)	Speed Control	Hall Bias Voltage (V)	Zener Diode Clamp Voltage (V)	Output Clamp Voltage (V)	Lock Time Ratio	Package
BD6701F	6.0 to 28.0	800	DMOS	0.3 (Io=200mA)	—	—	—	54	1 : 10	SOP8
BA6406F	4.0 to 28.0	70	Pre-Driver	—	—	—	—	—	1 : 4.5	SOP8
BA6506F	4.0 to 28.0	70	Pre-Driver	—	—	—	—	—	1 : 4.5	SOP8
BA6901F	3.5 to 28.0	70	Pre-Driver	—	PWM	—	—	—	1 : 10	SOP16

3-Phase Full-wave Fan Motor Drivers

BH67173NUX	5V MIN, 400 CLASS, Small Pkg	SENSOR LESS DRIVE, PWM 150, FG, FULL, T.S.D., LOCK, ALARM, IO LIMIT
BD6326NUX	5V MIN, 400 CLASS, Small Pkg	SENSOR LESS DRIVE, PWM 180, FG, FULL, T.S.D., LOCK, ALARM, IO LIMIT
BD63242EFV	12V MIN, 400 CLASS, Small Pkg	SENSOR LESS DRIVE, PWM 180, FG, FULL, T.S.D., LOCK, ALARM, IO LIMIT, MIN rpm
BD63441AFU	12V MIN, PRE DRIVER, Small Pkg	SENSOR LESS DRIVE, PWM 150, FG, FULL, T.S.D., LOCK, ALARM, IO LIMIT, SOFT START, MIN rpm
BD63251MUV	12V MIN, PRE DRIVER, Small Pkg	SENSOR LESS DRIVE, PWM 180, FG, FULL, T.S.D., LOCK, ALARM, IO LIMIT, SOFT START, MIN rpm

Part No.	Supply Voltage (V)	Io Max. (mA)	Power Transistor	Output Saturation Voltage (V)	Speed Control	Hall Bias Voltage (V)	Lock Time Ratio	Package
BH67173NUX	2.2 to 5.5	700	CMOS	Upper and Lower 0.25(Io=250mA)	Direct PWM	—	1 : 5	VSON010X3030
BD6326NUX	2.2 to 5.5	700	CMOS	Upper and Lower 0.25(Io=250mA)	Direct PWM	—	1 : 5	VSON010X3030
New BD63242EFV	5.0 to 16.0	1,000	DMOS	Upper and Lower 0.3(Io=300mA)	DC/Direct PWM	—	1 : 5*	HTSSOP-B16
BD63441AFU	5.5 to 16.0	10	Pre-Drive	—	DC/Direct PWM	—	1 : 10	SSOP-C20
BD63251MUV	5.5 to 15.0	10	Pre-Drive	—	DC/Direct PWM	1.5	1 : 10	VQFN024V4040

*SOSC terminal connect capacitor is 80pF

3-Phase Brushless Fan Motor Drivers For Household Appliances(White goods)

BM6202FS									
BM6203FS									
BM6204FS									
BM6205FS									
BM6206FS									
BM6207FS									
BM6208FS									
BM6209FS									

Part No.	Control	Output Device	Voltage Ratings (V)	Output Current (A)	Output On Resistance(Ω)	Diode Forward Voltage(V)	Package
BM6202FS	6 inputs	PrestoMOS™	600	1.5	2.7	1.1	SSOP-A54_23
BM6203FS	6 inputs	PrestoMOS™	600	2.5	1.7	1.1	SSOP-A54_23
BM6204FS	120°	PrestoMOS™	600	1.5	2.7	1.1	SSOP-A54_36
BM6205FS	120°	PrestoMOS™	600	2.5	1.7	1.1	SSOP-A54_36
BM6206FS	150°	PrestoMOS™	600	1.5	2.7	1.1	SSOP-A54_36
BM6207FS	150°	PrestoMOS™	600	2.5	1.7	1.1	SSOP-A54_36
BM6208FS	180° (Sinusoidal)	PrestoMOS™	600	1.5	2.7	1.1	SSOP-A54_36
BM6209FS	180° (Sinusoidal)	PrestoMOS™	600	2.5	1.7	1.1	SSOP-A54_36

3-Phase Brushless Fan Motor Controllers For Household Appliances(White goods)

BD62011AFS						
BD62012AFS						
BD62013AFS						
BD62014AFS						

Part No.	Supply Voltage (V)	Commutation Logic	Control Voltage Range (V)	Phase Control Range (deg)	FG Pulse Number	Hall Bias Switch	Package
BD62011AFS	10.0 to 18.0	180° (Sinusoidal)	2.1 to 5.4	0 to +40	4/12	—	SSOP-A24
BD62012AFS	10.0 to 18.0	150°	2.1 to 5.4	0 to +30	4/12	—	SSOP-A24
BD62013AFS	10.0 to 18.0	150°	2.1 to 5.4	0 to +30	12	✓	SSOP-A24
BD62014AFS	10.0 to 18.0	180° (Sinusoidal)	1.1 to 4.4	0 to +40	4/12	—	SSOP-A24

Driver for ODD

1ch System Motor Driver ICs Wide Application

Part No.	Power Supply (V)	Dynamic Range of Driver Output (V)	I/F Amp.	Mute of Driver Output	Regulator for DSP (V)	Protect Circuit for Low Power Supply	Protect for Abnormal Input	Temp. Protection	Standby Circuit	Package
BD7931F	4.5 to 14.0	7.5(V _{CC} =8V, R _L =500mA)	—	—	—	—	—	✓	✓	SOP8
BH6578FVM	4.5 to 5.5	4.5(V _{CC} =5V, R _L =500mA)	—	—	—	—	—	✓	—	MSOP8

2ch to 3ch System Motor Driver IC Actuator Applicable

Part No.	Power Supply (V)	I/F	FOCUS TILT	TRACKING	SLED	LOADING	SPINDLE	Short Circuit Protection Loading	Protect for Pickup	Package
BD8271EFV	4.5 to 14.0	Analog & PWM	1ch	—	2ch STTEPING	—	—	—	—	HTSSOP-B24

4ch System Motor Driver ICs Basic Type for CD player

Part No.	Power Supply (V)	I/F	FOCUS TILT	TRACKING	SLED	LOADING	SPINDLE	Short Circuit Protection for Loading	Protect for Pickup	Regulator	Reset	Package	Automotive Grade AEC-Q100
BD8226EFV	5.5 to 14.0	Analog & PWM	1ch	1ch	DC Select input	DC	DC	—	—	Variable voltage ×1	—	HTSSOP-B24	—
BD8229EFV	4.5 to 14.0	Analog & PWM	1ch	1ch	DC Select input	DC	DC	—	—	—	1 input 1 output	HTSSOP-B24	—
BD8266EFV-M	4.5 to 10.0	Analog & PWM	1ch	1ch	DC Select input	DC	DC	—	Self off	—	—	HTSSOP-B24	YES
BD8263EFV-M	4.5 to 10.0	Analog & PWM	1ch	1ch	DC Select input	DC	DC	✓	—	—	—	HTSSOP-B28	YES

5ch System Motor Driver ICs Loading Channel Added

Part No.	Power Supply (V)	I/F	FOCUS TILT	TRACKING	SLED	LOADING	SPINDLE	Short Circuit Protection for Loading	Protect for Pickup	Regulator	Package	Automotive Grade AEC-Q100
BD8205EFV-M	6.0 to 10.0	Analog & PWM	1ch	1ch	DC	DC	DC	—	—	—	HTSSOP-B24	YES
BD8203EFV	4.5 to 14.0	Analog & PWM	1ch	1ch	DC	DC	DC	—	—	Variable voltage ×1 5V Fixed ×1	HTSSOP-B40	—

Symbol Key	Voltage resistance	Output power system	Maximum output current	Built-in thermal shut-down circuit	Built-in under voltage lock out circuit	Built-in over current protection circuit	Output current limit can be set
	External capacitor for detecting motor lock not necessary	RPM pulse signal output	Built-in hall element power supply voltage				

6ch to 9ch System Motor Driver ICs Basic Type for DVD Player, Blu-ray												
Part No.	Power Supply (V)	I/F	FOCUS TILT	TRACKING	SLED	LOADING	SPINDLE	LVDS for SA	Short Circuit Protection for Loading	Protect for Pickup	Package	Automotive Grade AEC-Q100
BD8255MUV-M	4.5 to 5.5	SPI	1ch	1ch	2ch STTEPING	DC	3-Phase Brushless	—	✓	—	VQFN48SV7070	YES
BD8256EFV-M	4.5 to 10.5	SPI	2ch	1ch	2ch STTEPING	DC	3-Phase Brushless	2ch	✓	Self off	HTSSOP-B54	YES

System Motor Driver ICs for Half Height Drives(Sensorless) Space Saving Type										
Part No.	Supply Voltage (V)	ch	Output System	Output (Ω)	Output Gain	Under Voltage Protection	Overvoltage Protection	Input Abnormality Protection	Temperature Protection	Package
BD7763EFV	4.3 to 5.5	1 to 3ch	PWM	1.5	17.5dB	✓	—	✓	✓	HTSSOP-B54
		4, 5ch	PWM	1.3	17.5dB					
	10.8 to 13.2	6, 7ch	PWM	2.2	1.15A/V					
		8ch	PWM	1.0	1.15A/V					
		9ch	PWM	1.5	—					

System Motor Driver ICs for Slim Drives(3 sensors) Basic Type										
Part No.	Supply Voltage (V)	ch	Output System	Output (Ω)	Output Gain	Under Voltage Protection	Overvoltage Protection	Input Abnormality Protection	Temperature Protection	Package
BH5510KV/ BH5510KVT	4.0 to 5.5	1 to 3ch	PWM	1.3	14dB	✓	✓	✓	✓	VQFP48C/ TQFP48V
		4, 5ch	PWM	1.5	14dB					
		6ch	PWM	0.6	1A/V or 0.2A/V					
BH5511KV	4.0 to 5.5	1 to 3ch	PWM	1.3	17.5dB/8.0dB	✓	✓	✓	✓	VQFP48C
		4, 5ch	PWM	1.5	17.5dB					
		6ch	PWM	0.6	0.5A/V or 0.33A/V or 0.17A/V					

Drivers for Printer

3-Phase Brushless Motor Driver for Polygonal Mirrors For LBP, PPC										
Part No.	Supply Voltage (V)	Output Current (A)	Circuit Current (mA)	Input Threshold Voltage		Current Limit Detect Voltage (V)	ON Resistance (Ω)	Circuit Current When Motor Stop (mA)	PWM Frequency (kHz)	Package
				H Level(V)	L Level(V)					
BD67929EFV	19 to 28	2.5	4.0	3.0	1.5	0.5	1.35 (I _o =1.0A)	1.0	200	HTSSOP-B28

Motor Drivers with Brush for Printers									
Part No.	Supply Voltage (V)	Output Current (A)	Output Current Peak(A)	Circuit Current (mA)	Input Threshold Voltage		Output ON Resistance (Ω)	Package	
					H Level(V)	L Level(V)			
BD63821EFV	19 to 28	1.0	1.5	2.5	2.0	0.8	1.9(I _o =0.5A)	HTSSOP-B28	
BD63823EFV	19 to 28	2.0	2.8	2.5	2.0	0.8	0.65(I _o =1.5A)	HTSSOP-B28	
BD62210AEFV	8 to 28	1.0	1.5	2.5	2.0	0.8	1.9	HTSSOP-B28	
BD62220AEFV	8 to 28	2.0	2.8	2.5	2.0	0.8	0.65	HTSSOP-B28	

Bipolar Stepper Motor Drivers for Paper Feed / Carriage For LBP, PPC, Scanner, Photo, Printer, FAX, IJP							
Part No.	Supply Voltage(V)	Output Current (A)	Circuit Current (mA)	Input Threshold Voltage		Output ON Resistance (Ω)	Package
	V _{cc}			High Level Voltage(V)	Low Level Voltage(V)		
BD63801EFV	19 to 28	0.8	2.7	2.0	0.8	2.8	HTSSOP-B24
BD68715EFV	19 to 28	1.5	2.0	2.0	0.8	0.95	HTSSOP-B28
BD63715AEFV	19 to 28	1.5	2.0	2.0	0.8	0.95	HTSSOP-B28

3-Phase Brushless Motor Pre-Drivers for Paper Feed For LBP, PPC										
Part No.	Max. Voltage (V)	Supply Voltage (V)	Operating Temperature (°C)	Circuit Current (mA)	Input Threshold Voltage		External Threshold Voltage		PWM Frequency (kHz)	Package
					H Level(V)	L Level(V)	Upper(V)	Lower(V)		
BD6761FS	36	16 to 28	-35 to +75	15.0	2.2	0.8	V _{cc} +6	10.5	15	SSOP-A32
BD6762FV	36	16 to 28	-25 to +75	17.0	2.2	0.8	V _{cc} +6.8	10.8	16	SSOP-B40

3-Phase Brushless Motor Driver for Polygonal Mirrors For LBP, PPC : Current limit value is calculated by dividing current limit voltage by RNF resistance which is to detect the output current.
 Motor Drivers with Brush for Printers: The BD63821EFV and BD63823EFV are all pin-compatible. The BD62210AEFV and BD62220AEFV are all pin-compatible.

Driver for Digital Still Camera

5ch System Lens Drivers for Digital Still Cameras

Part No.	Supply Voltage (V)	Driver Output Max. Current (A)	Drive Method Examples of Actuator(Drived Motor, Driving System, and Output ON Resistance(Ω))				Input I/F	Reference Voltage Output For Output Setting Current(V)	Package (mm)
			AF	Zoom	Iris	Shutter			
BD6370GUL	2.7 to 5.5	0.5	ex. 1	STM(1, 2ch) Constant voltage/ FULL ON 1.4	DCM(3ch) Constant voltage/ FULL ON 1.4	DCM or VCM(4ch) Constant voltage/ Constant current/ FULL ON 1.4	VCM(5ch) Constant current 1.4	Parallel + Serial	Output current control using built-in D/A converter
			ex. 2	STM(1, 2ch) Constant voltage/ FULL ON 1.4	STM(1, 2, 3ch) Constant voltage/ FULL ON 1.4	DCM or VCM(4ch) Constant voltage/ Constant current/ FULL ON 1.4	VCM(5ch) Constant current 1.4		
BD6758MWV	2.5 to 5.5	0.8	ex.	STM(1, 2ch) FULL ON 1.2	DCM(3ch) FULL ON 1.2	DCM or VCM(4ch) FULL ON 1.2	VCM(5ch) Constant current 1.0	Parallel	1.2 (±3%)
BD6758KN	2.5 to 5.5	0.8	ex.	STM(1, 2ch) FULL ON 1.2	DCM(3ch) FULL ON 1.2	DCM or VCM(4ch) FULL ON 1.2	VCM(5ch) Constant current 1.0	Parallel	1.2 (±3%)

6ch System Lens Drivers for Digital Still Cameras

Part No.	Supply Voltage (V)	Driver Output Max. Current (A)	Drive Method Examples of Actuator(Drived Motor, Driving System, and Output ON Resistance(Ω))					Input I/F	Reference Voltage Output For Output Setting Current(V)	Package (mm)
			AF	Zoom	Iris	Shutter	Barrier			
BD6373GW	2.5 to 5.5	0.8	ex.	STM(1, 2ch) FULL ON 1.2	STM(3, 4ch) FULL ON 1.2	DCM or VCM(5ch) FULL ON 1.2	VCM(6ch) FULL ON 1.2	—	Parallel	—
BD6753KV	4.5 to 10.5 (1, 2ch) 2.0 to 10.5 (3 to 6ch)	0.8	ex.	STM(1, 2ch) FULL ON 1.2	STM(3, 4ch) FULL ON 1.2	DCM or VCM(5ch) PWM(±3%) 1.2	VCM(6ch) PWM(±3%) 1.2	—	Parallel + Serial	0.9 (±10%)

7ch System Lens Drivers for Digital Still Cameras

Part No.	Supply Voltage (V)	Driver Output Max. Current (A)	Drive Method Examples of Actuator(Drived Motor, Driving System, and Output ON Resistance(Ω))					Input I/F	Reference Voltage Output For Output Setting Current(V)	Package (mm)
			AF	Zoom	Iris	Shutter	Anti Shock			
BD6889GU	2.5 to 5.7	0.8	ex. 1	STM(1, 2ch) FULL ON 1.3	STM(3, 4ch) FULL ON 1.3	STM(5, 6ch) FULL ON 1.3	VCM(7ch) Constant current(±3%) 0.9	—	Parallel	0.9 (±2%)
			ex. 2	STM(1, 2ch) FULL ON 1.3	DCM(3ch) FULL ON 1.3	DCM(4ch) FULL ON 1.3	VCM(7ch) Constant current(±3%) 0.9	STM(5, 6ch) FULL ON 1.3		

Single and Dual-Channel Lens Drivers for SLRs(Single Lens Reflex)

Part No.	ch	Supply Voltage (V)	Driver Output Max. Current (A)	Drive Method Examples of Actuator(Drived Motor, Driving System, and Output ON Resistance(Ω))					Turn on Time	Turn off Time	Control Frequency	Package (mm)	
				Cleaner	AF	Zoom	Iris	Shutter					
BD65492MUV	2	1.8 to 16.0	1.0	ex.	—	STM(2ch) FULL ON 0.9	—	—	—	200ns(Including 80ns to Prevent from overlap current.)	80ns	500kHz (Max.)	VQFN024V4040 (4.0×4.0)H=1.0Max.
BD6735FV	2	2.0 to 8.0	1.0	ex.	—	—	—	STM(2ch) FULL ON 1.0	—	300ns(Including 90ns to Prevent from overlap current.)	100ns	100kHz (Max.)	SSOP-B20 (6.5×6.4)H=1.25Max.
BD6376GUL	1	2.0 to 9.0	1.0	ex.	—	—	DCM(1ch) FULL ON 0.45	—	—	200ns(Including 80ns to Prevent from overlap current.)	60ns	200kHz (Max.)	VCSP50L1 (1.6×1.6)H=0.55Max.
BD65491FV	1	1.8 to 16.0	1.2 Peak 4.0	ex.	—	—	—	—	Plunger(1ch) FULL ON 0.35	150ns(Including 80ns to Prevent from overlap current.)	50ns	500kHz (Max.)	SSOP-B16 (6.5×5.0)H=1.25Max.
BD6736FV	1	2.0 to 9.0	1.0 Peak 3.2	ex.	—	—	—	—	Plunger(1ch) FULL ON 0.35	1000ns(Including 800ns to Prevent from overlap current.)	100ns	100kHz (Max.)	SSOP-B20 (6.5×6.4)H=1.25Max.
BD65499MUV	1	4.0 to 27.0	0.5 Peak 2.0	ex.	Piezo(1ch) FULL ON 0.6	—	—	—	—	150ns(Including 80ns to Prevent from overlap current.)	50ns	300kHz (Max.)	VQFN028V5050 (5.0×5.0)H=1.0Max.
BD65494MUV	1	2.0 to 9.0	1.0 Peak 2.5	ex.	—	—	—	—	Plunger(1ch) FULL ON 0.55	200ns(Including 80ns to Prevent from overlap current.)	60ns	200kHz (Max.)	VQFN016V3030 (3.0×3.0)H=1.0Max.
BD65496MUV	1	1.8 to 16.0	1.2 Peak 5.0	ex.	—	—	—	—	Plunger(1ch) FULL ON 0.35	150ns(Including 80ns to Prevent from overlap current.)	50ns	500kHz (Max.)	VQFN024V4040 (4.0×4.0)H=1.0Max.

STM : Stepping motor, DCM : DC motor, VCM : Voice coil motor("Drive method examples of actuator" are recommendation. Another types may be evaluated.)

Microstep System Lens Drivers for Digital Cameras												
Part No.	Supply Voltage (V)	Driver Output Max. Current (A)	Drive Method Examples of Actuator(Drived Motor, Driving System, and Output ON Resistance(Ω))					Input I/F	Microstep Resolution	Package (mm)		
			AF	Zoom	Iris	Shutter	Others					
BU24020GU	2.7 to 3.6 (Logic) 2.7 to 5.5 (Driver)	0.5	ex. 1	STM(1, 2ch) μ-step(class-D) 1.5	STM(3, 4ch) μ-step(class-D) 1.5	—	—	—	3-wire serial	1,024	VCSP85H2 (2.6×2.6) H=1.0Max.	
			ex. 2	STM(1, 2ch) μ-step(class-D) 1.5	DCM(3ch) FULL ON(PWM) 1.5	VCM(4ch) FULL ON(PWM) 1.5	—	—				
BU24031GW	1.62 to 3.6 (I) 2.7 to 3.6 (Logic) 2.7 to 5.5 (Driver)	0.5	ex	STM(1, 2ch) μ-step(class-D) 2.0	DCM(4ch) FULL ON(PWM+ Speed Control) 2.0	VCM(3ch) FULL ON(PWM) 2.0	VCM(5ch) constant current 1.0	—	3-wire serial	1,024	UCSP75M2 (2.5×2.5) H=0.85Max.	
BU24033GW	1.62 to 3.6 (I) 2.7 to 3.6 (Logic) 2.7 to 5.5 (Driver)	0.5/0.6	ex. 1	STM(1, 2ch) μ-step(class-D) 1.5	STM(3, 4ch) μ-step(class-D) 1.5	VCM(5ch) FULL ON(PWM) 1.0	VCM(6ch) constant current 1.0	—	3-wire serial	1,024	UCSP75M3 (3.0×3.0) H=0.85Max.	
			ex. 2	STM(1, 2ch) μ-step(class-D) 1.5	DCM(5ch) FULL ON (PWM+Speed Control) 1.0	VCM(3ch) FULL ON(PWM) 1.5	VCM(6ch) constant current 1.0	DCM(4ch) FULL ON(PWM) 1.5				
BU24035GW	2.7 to 3.6 (Logic) 2.7 to 5.5 (Driver)	0.5/0.6	ex. 1	STM(1, 2ch) μ-step(class-D) 1.5	DCM(5ch) FULL ON (PWM+Speed Control) 1.0	STM(3, 4ch) μ-step(class-D) 1.5	VCM(6ch) constant current 1.0	—	3-wire serial	1,024	UCSP75M3 (3.1×3.1) H=0.85Max.	
			ex. 2	STM(1, 2ch) μ-step(class-D) 1.5	DCM(3ch) FULL ON (PWM+Speed Control) 1.5	VCM(5ch) FULL ON(PWM)/ constant current 1.0	VCM(6ch) constant current 1.0	VCM(4ch) FULL ON(PWM) 1.5				
BU24036MWV	2.7 to 3.6 (Logic) 2.7 to 5.5 (Driver)	0.5/0.6	ex. 1	STM(1, 2ch) μ-step(class-D) 2.0	DCM(5ch) FULL ON (PWM+Speed Control) 1.0	STM(3, 4ch) μ-step(class-D) 1.5	VCM(6ch) constant current 1.0	—	3-wire serial	1,024	UQFN040V5050 (5.0×5.0) H=1.0Max.	
			ex. 2	STM(1, 2ch) μ-step(class-D) 2.0	DCM(3ch) FULL ON (PWM+Speed Control) 1.5	VCM(5ch) FULL ON(PWM)/ constant current 1.0	VCM(6ch) constant current 1.0	VCM(4ch) FULL ON(PWM) 1.5				
BU24038GW	2.7 to 3.6 (Logic) 2.7 to 5.5 (Driver)	0.5	ex. 1	STM(1, 2ch) μ-step(class-D) 1.5	STM (3, 4ch) μ-step (class-D) 1.5	STM (5, 6ch) μ-step (class-D) 1.5	VCM(8ch) FULL ON(PWM) 1.5	VCM(9ch) constant current 1.0	DCM(7ch) FULL ON(PWM) 1.5	3-wire serial	1,024	UCSP75M3 (3.5×3.5) H=0.85Max.
			ex. 2	STM(1, 2ch) μ-step(class-D) 1.5	STM(5, 6ch) μ-step(class-D) 1.5	VCM(3ch) FULL ON (PWM) 1.5	VCM(4ch) FULL ON (PWM) 1.5	VCM(9ch) constant current 1.0	DCM(7ch) FULL ON(PWM) 1.5			

STM : Stepping motor, DCM : DC motor, VCM : Voice coil motor("Drive method examples of actuator" are recommendation. Another types may be evaluated.)

Mobile Phone Module Drivers

Parallel Interface Lens Driver for Voice Coil Motors

Part No.	Supply Voltage (V)	Applications	ch	Drive System	Driver Output Max. Current (mA)	Driver Output ON Resistance (Ω)	Input I/F	Input Mode Selection Terminal	Current Sense Resistor	Temperature Protection	Power Save Function	Back side coating	Package (mm)
BD6369GUL	2.5 to 5.5	Drive AF using voice coil motor.	1	Constant voltage (±5%)	400	0.8 (V _M =5V, I _o =0.4A)	Parallel	✓	—	✓	✓	with	VCSP50L2 (2.1×2.1) H=0.55Max.

2-wire Serial (I²C-compatible) Interface Lens Drivers for Uni-directional Voice Coil Motors

Part No.	Supply Voltage (V)	Applications	ch	Drive System	Driver Output Max. Current (mA)	Driver Output Low Voltage (V)	Input I/F	Ringing Compensation	Temperature Protection	Back side coating	Package (mm)
BU64241GWZ	2.3 to 4.8	Drive AF using voice coil motor.	0.25	Constant current (±10%)	130	0.15 (V _{CC} =3V, I _o =100mA)	I ² C Fm compatible	ISRC	✓	without	UCSP30L1 (1.3×0.77) H=0.33Max.
BU64243GWZ	2.3 to 4.8	Drive AF using voice coil motor.	0.25	Constant current (±10%)	130	0.15 (V _{CC} =3V, I _o =100mA)	I ² C Fm compatible	ISRC	✓	with	UCSP35L1 (0.77×1.3) H=0.40Max.
BU64244GWZ	2.3 to 4.8	Drive AF using voice coil motor.	0.25	Constant current (±10%)	130	0.15 (V _{CC} =3V, I _o =100mA)	I ² C Fm compatible	ISRC	✓	with	UCSP35L1 (0.77×1.3) H=0.36Max.
BU64291GWZ	2.3 to 4.8	Drive AF using voice coil motor.	0.5	Constant current (±5%)	100	0.25 (V _{CC} =3V, I _o =100mA)	I ² C Fm compatible	ISRC	✓	without	UCSP30L1 (0.77×1.3) H=0.33Max.
New BU64980AGWZ	2.3 to 4.8	Drive AF using voice coil motor.	0.25	Constant current (±5%)	100	0.25 (V _{CC} =3V, I _o =100mA)	I ² C Fm+ compatible	ISRC	✓	without	UCSP25L1 (0.72×1.13) H=0.3Max.
New BU64981AGWZ	2.3 to 4.8	Drive AF using voice coil motor.	0.25	Constant current (±5%)	100	0.25 (V _{CC} =3V, I _o =100mA)	I ² C Fm+ compatible	ISRC	✓	with	UCSP30L1A (0.72×1.13) H=0.33Max.

2-wire Serial (I²C-compatible) Interface Lens Drivers for Bi-directional Voice Coil Motors

Part No.	Supply Voltage (V)	Applications	ch	Drive System	Driver Output Max. Current (mA)	Driver Output ON Resistance (Ω)	Input I/F	Ringing Compensation	Temperature Protection	Back side coating	Package (mm)
BU64295GWZ	2.3 to 4.8	Drive AF using voice coil motor.	1	Constant current (±5%)	±100	2.0 (V _{DD} =3V)	I ² C Fm compatible	ISRC	✓	without	UCSP30L1 (1.3×1.2) H=0.33Max.
BU64296GWX	2.3 to 4.8	Drive AF using voice coil motor.	1	Constant current (±5%)	±100	2.0 (V _{DD} =3V)	I ² C Fm compatible	ISRC	✓	without	UCSP16X1 (0.77×1.2) H=0.20Max.
BU64297GWZ	2.3 to 4.8	Drive AF using voice coil motor.	1	Constant current (±5%)	±100	2.0 (V _{DD} =3V)	I ² C Fm compatible	ISRC	✓	with	UCSP35L1 (0.77×1.2) H=0.36Max.
New BU64985GWZ	1.6 to 1.98	Drive AF using voice coil motor.	1	Constant current (±5%)	±60	1.3 (V _{DD} =1.8V)	I ² C Fm+ compatible	ISRC	✓	with	UCSP30L1A (0.77×1.2) H=0.33Max.
New BU64987GWZ	1.6 to 1.98	Drive AF using voice coil motor.	1	Constant current (±5%)	±100	1.3 (V _{DD} =1.8V)	I ² C Fm+ compatible	ISRC	✓	with	UCSP30L1A (0.77×1.2) H=0.33Max.

2-wire Serial (I²C-compatible) Interface Lens Driver for Piezo Actuators

Part No.	Supply Voltage (V)	Applications	ch	Drive System	Driver Output Max. Current (mA)	Driver Output ON Resistance (Ω)	Input I/F	Base Clock	UVLO	Temperature Protection	Power Save Function	Back side coating	Package (mm)
BU64562GWZ	V _{CC} : 2.3 to 4.8	ex.1 Drive AF using piezo actuator. ex.2 Drive ZOOM using piezo actuator.	1	FULL ON	400	1.4 (V _{CC} =3V)	I ² C Fm compatible	Built-in 15MHz	✓	✓	✓	without	UCSP30L1 (1.90×0.77) H=0.33Max.

Parallel Interface Lens Driver for Stepping Motors

Part No.	Supply Voltage (V)	Applications	ch	Drive System	Driver Output Max. Current (mA)	Driver Output ON Resistance (Ω)	Input I/F	Input Mode Selection Terminal	Built-In Wave Sloping Comparator	Temperature Protection	Power Save Function	Back side coating	Package (mm)
BD6360GUL	2.3 to 5.5	ex.1 Drive AF using piezo actuator. ex.2 Drive ZOOM using stepping motor.	2	FULL ON	400	1.0 (V _{CC} =3V, I _o =0.4A)	Parallel	✓	✓	✓	✓	with	VCSP50L2 (2.1×2.1) H=0.55Max.

=Auto Focus =Zoom

A Motor / Actuator Drivers



LED Drivers

CONTENTS

LED Drivers	P. A80
Boost Converter LED Drivers	P. A80
Buck Converter LED Drivers	P. A81
Buck-Boost LED Drivers	P. A81
LED Drivers for Lighting	P. A81
Inductorless(Charge Pump) LED Drivers	P. A81
Constant Current/Serial-in Parallel-out LED Drivers	P. A82
LED Driver Support Function	P. A82

LED Drivers

Boost Converter LED Drivers

White LED Drivers with External FET

Part No.	Supply Voltage (V)	No. of LEDs	Output Voltage (V)	Output Current (mA)	Switching Frequency (MHz)	Primary Brightness Control Method	Control interface	Package (mm)
BD6583MUV-A	2.7 to 22.0	72 Max. (12 LEDs×6 rows) V _f restrictions exist	43.0 Max.	25 (Per row)	1.0	PWM signal from the PWMP0W/PWMDRV terminal Resistance switching at the ISET terminal	Pin logic setting	VQFN024V4040
BD9486F	9.0 to 18.0	120 Max. (120 LEDs×1 row)	400 Max.	400 Max.	0.05 to 0.8	PWM signal Analog signal	Pin logic setting	SOP16
New BD9411F	9.0 to 35.0	120 Max. (120 LEDs×1 row)	400 Max.	400 Max.	0.05 to 1.0	PWM signal Analog signal	Pin logic setting	SOP18
BD9413F	9.0 to 35.0	120 Max. (120 LEDs×1 row)	400 Max.	400 Max.	0.05 to 1.0	PWM signal Analog signal	Pin logic setting	SOP18
BD9483F	11.0 to 35.0	240 Max. (120 LEDs×2 rows)	400 Max.	400 Max.	0.05 to 0.8	PWM signal Analog signal	Pin logic setting	SOP24
BD9483FV	11.0 to 35.0	240 Max. (120 LEDs×2 rows)	400 Max.	400 Max.	0.05 to 0.8	PWM signal Analog signal	Pin logic setting	SSOP-B24
New BD9416F	9.0 to 35.0	240 Max. (120 LEDs×2 rows)	400 Max.	400 Max.	0.05 to 1.0	PWM signal Analog signal	Pin logic setting	SOP24
New BD9416FS	9.0 to 35.0	240 Max. (120 LEDs×2 rows)	400 Max.	400 Max.	0.05 to 1.0	PWM signal Analog signal	Pin logic setting	SSOP-A24
BD93941FP	9.0 to 35.0	72 Max. (18 LEDs×4 rows)	60.0 Max.	200	0.1 to 0.8	PWM signal Resistance switching at the ISET terminal Analog voltage control	Pin logic setting	HTSSOP-B20
BD93941EFV	9.0 to 35.0	72 Max. (18 LEDs×4 rows)	60.0 Max.	200	0.1 to 0.8	PWM signal Resistance switching at the ISET terminal Analog voltage control	Pin logic setting	HSOP20
BD9397EFV	9.0 to 35.0	84 Max. (14 LEDs×6 rows)	50.0 Max.	400 Max.	0.1 to 1.25	PWM signal Analog signal	Pin logic setting	HTSSOP-B40
BD9423EFV	9.0 to 35.0	84 Max. (14 LEDs×6 rows)	60.0 Max.	400 Max.	0.05 to 1.25	PWM signal Analog signal	Pin logic setting	HTSSOP-B40
BD9479FV	9.0 to 35.0	96 Max. (12 LEDs×8 rows)	40.0 Max.	500 Max.	0.1 to 0.8	PWM signal Analog signal	Pin logic setting	SSOP-B40

White LED Drivers with Integrated FET

BD60A00NUX	2.7 to 5.5	3 to 10 (10 LEDs×1 row)	40.0 Max.	30	0.6	PWM signal Resistance switching at the ISET terminal	Pin logic setting	VSON008X2030
BD60A60NUX	2.7 to 5.5	3 to 6 (6 LEDs×1 row)	26.0 Max.	30	0.6	PWM signal Resistance switching at the ISET terminal	Pin logic setting	VSON008X2030
BD65B60GWL	2.7 to 5.5	16 Max. (8 LEDs×2 rows)	28.5 Max.	25 (Per row)	1.1/0.6	I ² C BUS PWM signal Resistance switching at the ISET terminal	I ² C BUS + PWM	UCSP50L1 (1.4×1.8)H=0.55 Max.
BD6586MUV	2.7 to 5.5	24 Max. (6 LEDs×4 rows)	24.0 Max.	25 (Per row)	1.0	PWM signal Resistance switching at the ISET terminal	Pin logic setting	VQFN024V4040
BD65D00MUV	6.0 to 27.0	40 Max. (10 LEDs×4 rows)	Internal FET 40.0 Max. External FET 80.0 Max.	100	0.6 to 1.6	PWM signal Resistance switching at the ISET terminal Analog voltage control	Pin logic setting	VQFN028V5050
BD6142AMUV	4.2 to 27.0	80 Max. (10 LEDs×8 rows)	41.0 Max.	30 (Per row)	0.6 to 1.6	PWM signal Resistance switching at the ISET terminal Analog voltage control	Pin logic setting	VQFN024V4040

Synchronous White LED Drivers with Integrated FET

BD6071HFN	2.7 to 5.5	2/3 (3 LEDs×1 row)	14.0 Max.	35 (10V output)	1.0	PWM signal from EN terminal	—	HSO8
BD6072HFN	2.7 to 5.5	3/4 (4 LEDs×1 row)	18.0 Max.	35 (14V output)	1.0	PWM signal from EN terminal	—	HSO8
BD6079GWL	2.3 to 5.5	10 Max. (2 LEDs×5 rows)	8.1 Max.	30	2.0	PWM signal from EN terminal	—	UCSP50L1 (1.4×1.8)H=0.55 Max.

LED Camera Flash Drivers

Part No.	Supply Voltage (V)	Number of LED	Output Voltage (V)	Output Current	Switching Frequency (MHz)	Control Interface	Package (mm)
BD6164GUT	2.7 to 4.5	1 (High power LED)	4.7 Max.	52,72mA (Torch mode) 260,280,300,320mA (Flash mode)	4	I ² C BUS	VCSP60N1 (1.5×1.1)H=0.675 Max.
BD7710GWL	2.7 to 5.5	3CH · 1 to 2 serial (large current LED)	5.5 Max.	CH1=0 to 400mA CH2=0 to 800mA CH3=0 to 400mA CH1,2,3 short=0 to 1.6A	2	I ² C BUS	UCSP50L2
BD7757MWX	2.7 to 5.0	1CH · 1 to 2 serial (large current LED)	5.1 Max.	0 to 1.5A	2	UPIC*	VSON014X3020

White LED Driver for Head Light

Part No.	Supply Voltage (V)	Application	Number of Channel (ch)	Maximum Input Voltage (V)	Output Current	Dimmer Mode	DC/DC	Operating Temperature (C)	Package	Automotive Grade AEC-Q100
BD18351EFV-M	4.5 to 65.0	Head Lamp/DRL	1	65	Depend on Extra parts	PWM/DC	Boost	-40 to +125	HTSSOP-B24	YES

LED Camera Flash Drivers : *UPIC : Uni-Port Interface Control

Buck Converter LED Drivers

Buck Converter LED Lighting Drivers for DC/DC Converter type

Part No.	Supply Voltage (V)	Maximum Output Current (A)	Ron (Ω)	Operating Frequency (kHz)	Over Current Protection	Thermal Shut Down Protection	Package
BD9207FPS	8.0 to 35.0	1.5	1.0(Typ.)	900	✓	✓	TO252S-5
Part No.	Supply Voltage (V)	Switching Terminal Voltage (V)	Ron (Ω)	Operating Frequency (kHz)	Over Current Protection	Thermal Shut Down Protection	Package
BM531Q11	9.0 to 35.0	250	0.93(Typ.)	440 Max.	✓	✓	DIP7AK
BM533Q11	10.0 to 35.0	250	0.93(Typ.)	440 Max.	✓	✓	DIP7AK

White LED Driver for PFC Direct Connection Current Resonance type

Part No.	Supply Voltage (V)	Drive Method	Oscillation Frequency Variable Range (kHz)	Primary Brightness Control Method	Control Interface	Package
BD94121F	9.0 to 18.0	Half Bridge	30 to 300	PWM signal Analog signal	Pin logic setting	SOP18

Buck-Boost LED Drivers

White LED Drivers

Part No.	Power Supply (V)	Boost FET	Number of Channel (ch)	Output Voltage (V)	Output Current (mA)	Switching Frequency (MHz)	PWM Dimming Ratio	Operating Temperature (°C)	Package	Automotive Grade AEC-Q100
BD8119FM-M	5.0 to 30.0	External	4	30 Max.	150 Max./ch	0.25 to 0.55	200 : 1@200Hz	-40 to +95	HSOP-M28	Preparing
BD81A24EFV-M	4.5 to 35.0	Internal	4	35 Max.	120 Max./ch	0.20 to 2.2	5,000 : 1@200Hz	-40 to +125	HTSSOP-B28	YES
BD81A24MUV-M	4.5 to 35.0	Internal	4	35 Max.	120 Max./ch	0.20 to 2.2	5,000 : 1@200Hz	-40 to +125	VQFN28SV5050	YES
BD81A24MUF-M	4.5 to 35.0	Internal	4	35 Max.	120 Max./ch	0.20 to 2.2	5,000 : 1@200Hz	-40 to +125	VQFN28FV5050	YES
BD81A44EFV-M	4.5 to 35.0	External	4	35 Max.	120 Max./ch	0.20 to 2.2	5,000 : 1@200Hz	-40 to +125	HTSSOP-B28	YES
BD81A44MUV-M	4.5 to 35.0	External	4	35 Max.	120 Max./ch	0.20 to 2.2	5,000 : 1@200Hz	-40 to +125	VQFN28SV5050	YES
BD81A44MUF-M	4.5 to 35.0	External	4	35 Max.	120 Max./ch	0.20 to 2.2	5,000 : 1@200Hz	-40 to +125	VQFN28FV5050	YES

White LED Driver for Head Light

Part No.	Power Supply (V)	Application	Number of Channel (ch)	Maximum Input Voltage (V)	Output Current	Dimmer Mode	DC/DC	Operating Temperature (°C)	Package	Automotive Grade AEC-Q100
BD8381AEFV-M	5.0 to 30.0	Head Lamp/DRL	1	50	Depend on Extra parts	PWM/DC	Buck-Boost, Boost, Buck	-40 to +125	HTSSOP-B28	Preparing

LED Drivers for Lighting

AC/DC Controller ICs for Mains Dimmable LED Lighting

Part No.	Supply Voltage (V)	Input AC Voltage (Vac)	Dimming Method	LED Average Current (mA)	Switching Frequency (kHz)	Package
BD555BKFV	15 to 39	80 to 275	TRIAC PWM, LINEAR	100 to 800	40 to 400	SSOP-B14
BD521GOFJ	8.9 to 25.0	80 to 275	—	up to 1000	20 to 300	SOP-J8

AC/DC Controller IC for LED Lighting Included 650V MOSFET

BM521Q25F	8.9 to 25.0	80 to 275	—	up to 200	20 to 300	SOP8
------------------	-------------	-----------	---	-----------	-----------	------

Inductorless(Charge Pump) LED Drivers

White LED Drivers

Part No.	Supply Voltage (V)	No. of LEDs	Charge Pump Step-up Circuit			Primary Brightness Control Method	Control Interface	Package
			Output Voltage (V)	Output Current (mA)	Pump Frequency			
BD1604MUV	2.7 to 5.5	1 to 4	4.5 Max.	120	1.0MHz	PWM control via EN terminal Resistance switching at ISET terminal	Pin logic setting	VQFN016V3030
BD2606MVV	2.7 to 5.5	1 to 6	4.7 Max.	120	250kHz/ 1.0kHz	Built-in 64-step current DAC (0.5 to 32mA)	I ² C BUS	SQFN016V4040
BU90030G	2.0 to 4.0	1 to 2 (parallel connection)	4.2 Max.	80	1.5MHz	SHD control via PWM terminal	Pin logic setting	SSOP6

Constant Current/Serial-in Parallel-out LED Drivers

Parallel-out LED Drivers								
Part No.	Supply Voltage (V)	No. of LEDs	Constant Current Driver				Control Interface	Package
			Max. Current Setting Method	Max. Current	Channel to Channel Matching	Brightness Control		
BD1754HFN	2.7 to 5.5	1 to 4 (parallel connection)	Resistance change at ISET terminal	32mA (at an ISET resistance of 120kΩ)	3% Max. (at 1V LED pin voltage)	Built-in 64-step current DAC	UPIC*	HSO8
BD2802GU	2.7 to 5.5	6 (RGB 2ch)	Resistance change at ISET terminal	30.48mA (at an ISET resistance of 100kΩ)	10% Max. (at 1V LED pin voltage)	Built-in 128-step current DAC/ Inductorless (Charge Pump)	I ² C BUS	VCSP85H2
BD2812GU	2.7 to 5.5	6 (RGB 2ch)	Resistance change at ISET terminal	30.48mA (at an ISET resistance of 100kΩ)	10% Max. (at 1V LED pin voltage)	Built-in 128-step current DAC	I ² C BUS	VCSP85H2
BD9206EFV	8.0 to 30.0	36 Max.	VSET Pin voltage setting	32mA (at VSET=3V)	5% Max. (at 1V LED pin voltage)	—	Pin logic setting	HTSSOP-B20
BD9271KUT	9.0 to 35.0	192 Max.	Resistance change at S terminal	100mA (Sx=1.0V)	3% Max. (at 0.3V S pin voltage)	Built-in 4096-step	3-Wire Serial	TQFP64UM

Parallel-out LED Drivers											
Part No.	Supply Voltage (V)	Output Voltage (V)	No. of Output (ch)	Output Method	Max. LED Current	Each Output Format	Other	Control Method	Max. Clock Frequency (MHz)	Package	Automotive Grade AEC-Q100
BD8378FV-M	3.0 to 5.5	35	8	Open Drain	50mA/ch	ON/OFF	—	SPI	1.25	SSOP-B16	YES
BD8379FV-M	3.0 to 5.5	35	12	Open Drain	50mA/ch	ON/OFF	—	SPI	1.25	SSOP-B20	YES
BD8379EFV-M	3.0 to 5.5	35	12	Open Drain	50mA/ch	ON/OFF	—	SPI	1.25	HTSSOP-B20	YES
BD2808MUV-M	3.0 to 5.5	20	RGB × 8 (24ch)	Constant Current	50mA/ch	Built-in 64-step current DAC for RGB	Built-in 256-step PWM control for all channel	2-Wire Serial	1.0	VQFN48MVCV070	YES

Dot Matrix LED Drivers												
Part No.	Supply Voltage (V)	LED Matrix	Max. LED Current	Built-in Pattern		Matrix Data RAM	Mobile Light	PWM Dimming (step)	Current Setting (step)	Interface	Max. Clock Frequency	Package (mm)
				Scroll	Slope							
BU26507GUL	2.7 to 5.5	5 × 6 30dots	42.5mA/Line	✓	✓	2pages	—	64	16	I ² C BUS/SPI (2 address/—)	400kHz/13MHz	VCSP50L2 (2.5×2.5)H=0.55Max.
BU26503GUL	2.7 to 5.5	7 × 17 119dots	30mA/Line	✓	✓	2pages	—	64	16	I ² C BUS/SPI (2 address/—)	400kHz/13MHz	VCSP50L3 (3.6×3.6)H=0.55Max.
BU26503KS2	2.7 to 5.5	7 × 17 119dots	30mA/Line	✓	✓	2pages	—	64	16	I ² C BUS/SPI (2 address/—)	400kHz/13MHz	SQFP-T52
BU16501KS2	2.7 to 5.5	8 × 16 128dots	42.5mA/Line	—	—	1page	—	64	16	I ² C BUS/SPI (2 address/—)	400kHz/13MHz	SQFP-T52

LED Source Drivers											
Part No.	Supply Voltage (V)	Application	Number of Channel (ch)	Driver	Maximum Input Voltage(V)	Maximum Current (mA)	Dimmer Mode	Accuracy of Current	Operating Temperature (°C)	Package	Automotive Grade AEC-Q100
BD18340FV-M	4.5 to 19.0	DRL/Position/FOG/ Turn/Rear	1 to 10	Controller (external PNP)	70	Total 1,000	PWM/DC	±3 (Ta=25°C to 125°C)	-40 to +125	SSOP-B16	YES
BD18341FV-M	4.5 to 19.0	DRL/Position/FOG/ Turn/Rear	1 to 10	Controller (external PNP)	70	Total 1,000	PWM/DC	±3 (Ta=25°C to 125°C)	-40 to +125	SSOP-B16	YES
BD8372EFJ-M	5.5 to 40.0	DRL/Position/FOG/ Turn/Rear	1	Internal	50	200	High Current/ Low Current	±3 (Ta=25°C)	-40 to +125	HTSOP-J8	YES
BD8372HFP-M	5.5 to 40.0	DRL/Position/FOG/ Turn/Rear	1	Internal	50	200	High Current/ Low Current	±3 (Ta=25°C)	-40 to +125	HRP7	YES
BD8374EFJ-M	4.5 to 42.0	DRL/Position/FOG/ Turn/Rear	1	Internal	50	500	PWM	±3 (Ta=25°C)	-40 to +125	HTSOP-J8	YES
BD8374HFP-M	4.5 to 42.0	DRL/Position/FOG/ Turn/Rear	1	Internal	50	500	PWM	±3 (Ta=25°C)	-40 to +125	HRP7	YES
BD83732HFP-M	4.5 to 42.0	DRL/Position/FOG/ Turn/Rear	1	Internal	50	500	PWM/DC	±3 (Ta=25°C)	-40 to +125	HRP7	YES
BD83733HFP-M	4.5 to 42.0	DRL/Position/FOG/ Turn/Rear	1	Internal	50	500	PWM/DC	±3(Ta=25°C)	-40 to +125	HRP7	YES

Parallel-out LED Drivers : *UPIC : Uni-Port Interface Control

LED Driver Support Function

PWM Signal Generator with Ambient Light Control for LED Driver IC					
Part No.	Supply Voltage (V)	ALC* (Sensor)	Other	Control Interface	Package
BD9478F	4.5 to 5.5	—	PWM signal Synchronous signal output	PWM input	SOP8

*ALC : Auto Luminous Control



Display Drivers

CONTENTS

TFT Driver Series	P. A84
Driver for Large LCD Panels	P. A84
Drivers for Small to Medium LCD Panels(LAPIS Semiconductor products)	P. A84
TN/STN LCD Driver Series	P. A84
LCD Segment Drivers	P. A84
Common/Segment Drivers for Dot Matrix LCD(LAPIS Semiconductor products)	P. A85
Controller Drivers for Graphic LCD(LAPIS Semiconductor products)	P. A85
Controller Drivers for Character LCD(LAPIS Semiconductor products)	P. A85
Controller Drivers for Low Duty LCD(LAPIS Semiconductor products)	P. A86
VFD Driver Series	P. A86
Anode/Grid Drivers for VFD(LAPIS Semiconductor products)	P. A86
Controller Drivers for Character VFD(LAPIS Semiconductor products)	P. A86
Controller Drivers for Low Duty VFD(LAPIS Semiconductor products)	P. A86
Car Clock Drivers (LAPIS Semiconductor products)	P. A86

TFT Driver Series

Driver for Large LCD Panels

6bit RSDS™ Source Driver							
Part No.	Function	Gray Scale	Number of Outputs	Driver Output Voltage (V) Max.	Max.Clock Frequency (MHz) Max.	Logic Power Supply Voltage (V)	Package
BU95306	RSDS™ I/F R-DAC Type	6bit	600/618/630/642	13.5	85	2.7 to 3.6	COF

Note : RSDS™ is the trademark of signal interface technology proposal by National Semiconductor Corporation of the U.S.A.

Drivers for Small to Medium LCD Panels

(LAPIS Semiconductor products)

TFT-LCD Drivers									
Part No.	Type	Logic Supply Voltage (V)	LCD Voltage (V)	Number of Driver Outputs	I/F	Operating Temperature (°C)	Package	Halogen Free Support*1	Automotive Grade*2
ML9860B	Source	2.1 to 3.6	10.0 to 14.6	480	RSDS	-40 to +95	Au bump chip	✓	YES
ML9863A	Source	2.4 to 3.6	8.0 to 14.6	960/804/792/768	CMOS/RSDS	-40 to +95	Au bump chip	✓	YES
ML9881	Source	2.7 to 3.6	8.0 to 14.6	1440/1284/1278/1260/1200/1080/1026/1020	RSDS/mini-LVDS	-40 to +95	Au bump chip	✓	YES
ML9882	Source	2.7 to 3.6	8.0 to 14.6	1440/1284/1278/1260/1200/1080/1026/1020	RSDS/mini-LVDS	-40 to +95	Au bump chip	✓	YES
ML9883	Source	2.7 to 3.6	8.0 to 14.6	1440/1284/1278/1200/1080/1062/1026/1020	RSDS/mini-LVDS	-40 to +95	Au bump chip	✓	YES
ML9872	Gate	2.4 to 3.6	Up to 40	540/480/400/384/360/300/240	CMOS	-40 to +105	Au bump chip	✓	YES
ML9873	Gate	2.4 to 3.6	Up to 40	960/800/768/720/684/682/640/600/540/512	CMOS	-40 to +105	Au bump chip	✓	YES

*1 : A check mark of halogen free support means that we will be able to ship out the halogen free products. For details, please inquire to the sales.

*2 : Please inquire to the sales for AEC-Q100.

TN/STN LCD Driver Series

LCD Segment Drivers

Low Duty LCD Segment Drivers																
Part No.	Display (dots)	Outputs		Operating Voltage(V)		Operating Temperature (°C)	Duty	Bias	I/F	EVR	GPO	Independent Blink	LED Driver	PWM Gen.	Keyscan	Package
		SEG	COM	I/F Power Supply (VDD)	LCD Power Supply (VLCD)											
New BU97550CH-3W	528	66	8	2.7 to 6.0		-40 to +85	1/8,1/7,1/5 1/4,1/3,Static	1/4,1/3, 1/2	3wire+ KEYOUT	✓	9port (9ch PWM)	—	—	9ch 9bit	5×6 Max. 30Key	CHIP
New BU9797AFUV	144	36	4	2.5 to 5.5		-40 to +85	1/4	1/3	2wire	—	—	—	—	—	—	TSSOP-C48V
BU9796AMUV	48	12	4	2.5 to 5.5		-40 to +85	1/4	1/3,1/2	2wire	—	—	—	—	—	—	VQFN024V4040
BU9796AFS	80	20	4	2.5 to 5.5		-40 to +85	1/4	1/3,1/2	2wire	—	—	—	—	—	—	SSOP-A32
BU9795AFV	108	27	4	2.5 to 5.5		-40 to +85	1/4	1/3,1/2	3wire	—	—	—	—	—	—	SSOP-B40
BU9795BGUW	124	31	4	2.5 to 5.5		-40 to +85	1/4	1/3,1/2	3wire	—	—	—	—	—	—	VBGA049W040A
BU9795AKV	140	35	4	2.5 to 5.5		-40 to +85	1/4	1/3,1/2	3wire	—	—	—	—	—	—	VQFP48C
BU9795ZKS2	140	35	4	2.5 to 5.5		-40 to +85	1/4	1/3,1/2	3wire	—	—	—	—	—	—	SQFP-T52
BU9794AKV	200	50	4	2.5 to 5.5	2.5 to 5.5	-40 to +85	1/4	1/3,1/2	3wire	—	—	—	—	—	—	VQFP64
BU9799KV	200	50	4	2.5 to 5.5	2.5 to 5.5	-40 to +85	1/4	1/3,1/2	2wire	✓	—	—	—	—	—	VQFP64
BU97950FUV	280	35	8	2.5 to 5.5	2.5 to 5.5	-40 to +85	1/8	1/4	2wire	✓	—	—	—	—	—	TSSOP-C48V
BU97941FV	104	26	4	1.8 to 3.6	2.7 to 5.5	-40 to +85	1/4,1/3, Static	1/3	3wire	—	—	—	4port	—	—	SSOP-B40
BU97930MUV	108	27	4	1.8 to 3.6	2.7 to 5.5	-40 to +85	1/4,1/3, Static	1/3	3wire	—	4port	✓	1port	1ch 8bit	—	VQFN040V6060
BU97931FV	112	28	4	1.8 to 3.6	2.7 to 5.5	-40 to +85	1/4,1/3, Static	1/3	3wire	—	5port	✓	1port	1ch 8bit	—	SSOP-B40
BU97981MUV	168	42	4	1.8 to 3.6	3.3 to 5.5	-30 to +75	1/4,1/3, Static	1/3	3wire	—	27port	✓	3port	2ch 12bit	—	VQFN56AV8080
BU97981KV	196	49	4	1.8 to 3.6	3.3 to 5.5	-30 to +75	1/4,1/3, Static	1/3	3wire	—	31port	✓	3port	2ch 12bit	—	VQFP64
BU97981GU	196	49	4	1.8 to 3.6	3.3 to 5.5	-30 to +75	1/4,1/3, Static	1/3	3wire	—	31port	✓	3port	2ch 12bit	—	VBGA064T050A
BU97501KV	204	51	4	2.7 to 6.0	4.5 to 6.0	-40 to +85	1/4,1/3	1/3,1/2	3wire+ KEYOUT	—	4port	—	—	—	5×6 Max. 30Key	VQFP64
BU97530KVT	445	89	5	2.7 to 6.0		-40 to +85	1/5,1/4,1/3, Static	1/3,1/2	3wire+ KEYOUT	✓	9port (9ch PWM)	—	—	9ch 8bit	5×6 Max. 30Key	TQFP100V

Low Duty LCD Segment Drivers for Automotive Application

Part No.	Display (dots)	Outputs		Operating Voltage(V)		Operating Temperature (°C)	Duty	Bias	I/F	EVR	GPO	Independent Blink	LED Driver	PWM Gen.	Keyscan	Package	Automotive Grade AEC-Q100
		SEG	COM	I/F Power Supply(VDD)	LCD Power Supply(VLCD)												
New BU97601FV-M	116	29	4	2.7 to 6.0		-40 to +85	1/4,1/3,1/2, Static	1/3,1/2	3wire + KEYOUT	✓	16port (16ch PWM)	—	—	6ch 9bit	4x5 Max. 20Key	SSOP-B40	YES
BU9797FUV-M	144	36	4	2.5 to 5.5		-40 to +85	1/4	1/3,1/2	2wire	—	—	—	—	—	—	TSSOP-C48V	YES
BU97510CKV-M	216	54	4	2.7 to 6.0		-40 to +85	1/4,1/3	1/3,1/2	3wire	—	6port (6ch PWM)	—	—	6ch 6bit	—	VQFP64	YES
BU97520AKV-M	276	69	4	2.7 to 6.0		-40 to +85	1/4,1/3	1/3,1/2	3wire + KEYOUT	—	6port (6ch PWM)	—	—	6ch 8bit	5x6 Max. 30Key	VQFP80	YES
BU97530KVT-M	445	89	5	2.7 to 6.0		-40 to +85	1/5,1/4,1/3, Static	1/3,1/2	3wire + KEYOUT	✓	9port (9ch PWM)	—	—	9ch 8bit	5x6 Max. 30Key	TQFP100V	YES
BU97540KV-M	335	67	5	2.7 to 6.0		-40 to +85	1/5,1/4,1/3, Static	1/3,1/2	3wire + KEYOUT	✓	9port (9ch PWM)	—	—	9ch 9bit	5x6 Max. 30Key	VQFP80	YES
BU97550KV-M	528	66	8	2.7 to 6.0		-40 to +85	1/8,1/7,1/5,1/4, 1/3,Static	1/4,1/3,1/2	3wire + KEYOUT	✓	9port (9ch PWM)	—	—	9ch 9bit	5x6 Max. 30Key	VQFP80	YES
BU91600FV-M	116	29	4	2.7 to 6.0		-40 to +105	1/4,1/3,1/2, Static	1/3,1/2	3wire + KEYOUT	✓	16port (16ch PWM)	—	—	6ch 9bit	4x5 Max. 20Key	SSOP-B40	YES
BU91600FUV-M	148	37	4	2.7 to 6.0		-40 to +105	1/4,1/3,1/2, Static	1/3,1/2	3wire + KEYOUT	✓	16port (16ch PWM)	—	—	6ch 9bit	4x5 Max. 20Key	TSSOP-C48V	YES
BU91501KV-M	204	51	4	2.7 to 6.0	4.5 to 6.0	-40 to +105	1/4,1/3	1/3,1/2	3wire + KEYOUT	—	4port	—	—	5x6 Max. 30Key	—	VQFP64	YES
BU91510KV-M	216	54	4	2.7 to 6.0		-40 to +105	1/4,1/3	1/3,1/2	3wire	—	6port (6ch PWM)	—	—	6ch 6bit	—	VQFP64	YES
BU91520KV-M	276	69	4	2.7 to 6.0		-40 to +105	1/4,1/3	1/3,1/2	3wire + KEYOUT	—	6port (6ch PWM)	—	—	6ch 8bit	5x6 Max. 30Key	VQFP80	YES
BU91530KVT-M	445	89	5	2.7 to 6.0		-40 to +105	1/5,1/4,1/3, Static	1/3,1/2	3wire + KEYOUT	✓	9port (9ch PWM)	—	—	9ch 8bit	5x6 Max. 30Key	TQFP100V	YES
New BU91795MUF-M	48	12	4	2.5 to 6.0		-40 to +105	1/4	1/3	2wire	—	—	—	—	—	—	VQFN24FV4040	YES
New BU91796FS-M	80	20	4	2.5 to 6.0		-40 to +105	1/4	1/3	2wire	—	—	—	—	—	—	SSOP-A32	YES
BU91796MUF-M	80	20	4	2.5 to 6.0		-40 to +105	1/4	1/3	2wire	—	—	—	—	—	—	VQFN32FV5050	YES
BU91797MUF-M	144	36	4	2.5 to 6.0		-40 to +105	1/4	1/3	2wire	—	—	—	—	—	—	VQFN48FV7070	YES
BU91799KV-M	200	50	4	2.5 to 6.0	2.5 to 6.0	-40 to +105	1/4	1/3	2wire	✓	—	—	—	—	—	VQFP64	YES
BU91R63CH-M3BW	176	44	4	2.7 to 6.0	2.7 to 6.0	-40 to +105	1/4,1/3,1/2, Static	1/3,1/2	2wire	✓	—	—	—	—	—	Au Bump Chip	YES
New BU91797FUV-M	144	36	4	2.5 to 6.0		-40 to +105	1/4	1/3	2wire	—	—	—	—	—	—	TSSOP-C48V	YES

Low Duty LCD Segment Drivers for Industrial Application

Part No.	Display (dots)	Outputs		Operating Voltage(V)		Operating Temperature (°C)	Duty	Bias	Interface	EVR	GPO	Independent Blink	LED Driver	PWM Gen.	Keyscan	Package
		SEG	COM	I/F Power Supply(VDD)	LCD Power Supply(VLCD)											
BU97941FV-LB	104	26	4	1.8 to 3.6	2.7 to 5.5	-40 to +85	1/4,1/3,Static	1/3	3wire	—	—	—	—	4port	—	SSOP-B40
BU9795AFV-LB	108	27	4	2.5 to 5.5		-40 to +85	1/4	1/3,1/2	3wire	—	—	—	—	—	—	SSOP-B40
BU97931FV-LB	112	28	4	1.8 to 3.6	2.7 to 5.5	-40 to +85	1/4,1/3,Static	1/3	3wire	—	5port	✓	1port	1ch 8bit	—	SSOP-B40

Common/Segment Drivers for Dot Matrix LCD

(LAPIS Semiconductor products)

LCD Drivers

Part No.	No. of Driver Output	Max. Driving Display Size	Logic Supply Voltage(V)	Driver Supply Voltage (V)	Operating Temperature (°C)	Feature	Package	Halogen Free Support*1
ML9460	240	320x240 (QVGA)	2.5 to 5.5	up to 43	-30 to +75	Output change 240/200/160/120	Au bump chip	✓
ML9461B	320		2.5 to 5.5	2.6 to 5.5	-30 to +75	Output change 320/240/200	Au bump chip	✓

*1 : A check mark of halogen free support means that we will be able to ship out the halogen free products. For details, please inquire to the sales.

Controller Drivers for Graphic LCD

(LAPIS Semiconductor products)

LCD Controller Drivers

Part No.	Max. No. of Segment Outputs	Max. Driving Display Size	Logic Supply Voltage (V)	Driver Supply Voltage (V)	Operating Temperature (°C)	Feature	Package	Halogen Free Support*1	Automotive Grade*2
ML9058E	132	132x65 dots	3.7 to 5.5	6 to 18	-40 to +85	Integrated RAM/ Boost circuit	Au bump chip	✓	YES
ML9059E	132	132x49 dots	3.7 to 5.5	6 to 18	-40 to +85	Integrated RAM/ Boost circuit	Au bump chip	✓	YES
ML9445	180	180x65 dots	2.7 to 5.5	6 to 18.5	-40 to +105	Integrated RAM/ Boost circuit	Au bump chip	✓	YES
ML9092-01	56	56x10 dots	4.5 to 5.5	4.5 to 16.5	-40 to +85	Integrated RAM/ Boost circuit/PWM	TQFP100	✓	YES
ML9092-02	60	60x10 dots	4.5 to 5.5	4.5 to 16.5	-40 to +85	Integrated RAM/ Boost circuit	TQFP100	✓	YES
ML9092-03						Integrated RAM			
ML9092-04						Integrated RAM/PWM			

*1 : A check mark of halogen free support means that we will be able to ship out the halogen free products. For details, please inquire to the sales.

*2 : Please inquire to the sales for AEC-Q100.

Controller Drivers for Character LCD

(LAPIS Semiconductor products)

LCD Controller Drivers

Part No.	Max. No. of Segment Outputs	Digits/Lines	Logic Supply Voltage (V)	Driver Supply Voltage (V)	Operating Temperature (°C)	Feature	Package	Halogen Free Support*1
ML9042-0x	100	5x8 dots, 20 charactersx2 lines	2.7 to 5.5	2.7 to 5.5	-40 to +85	Built-in bias register 2kΩ/ Supports custom fonts	Au bump chip	✓
ML9042-1x	100	5x8 dots, 20 charactersx2 lines	2.7 to 5.5	2.7 to 5.5	-40 to +85	Built-in bias register 4kΩ/ Supports custom fonts	Au bump chip	✓
ML9042-2x	100	5x8 dots, 20 charactersx2 lines	2.7 to 5.5	2.7 to 5.5	-40 to +85	Built-in bias register 10kΩ/ Supports custom fonts	Au bump chip	✓

*1 : A check mark of halogen free support means that we will be able to ship out the halogen free products. For details, please inquire to the sales.



Controller Drivers for Low Duty LCD

(LAPIS Semiconductor products)

LCD Controller Drivers(Package Product)														
Part No.	Max. No. of Segment Outputs	Max. No. of Driving Segments					Internal Oscillation Frame Frequency (Hz)	Logic Supply Voltage (V)	Driver Supply Voltage (V)	Operating Temperature (°C)	Feature	Package	Halogen Free Support ^{*1}	Automotive Grade ^{*2}
		static	1/2	1/3	1/4	1/5								
ML9470-12	80	80	160	—	—	—	—	3.0 to 5.5 (single)	-40 to +105	Supports external clock input	QFP100-1420-0.65	✓	YES	
ML9471	80	—	—	240	320	400	—	3.0 to 5.5 (single)	-40 to +105	Supports external clock input	TQFP100	✓	YES	
ML9472	60	60	120	—	—	—	—	3.0 to 5.5 (single)	-40 to +105	Supports external clock input	P-TQFP80-1212-0.50	✓	YES	
ML9473	60	—	—	180	240	300	—	3.0 to 5.5 (single)	-40 to +105	Supports external clock input	P-TQFP80-1212-0.50	✓	YES	
ML9475	40	—	—	120	160	—	—	3V ± 10%/ 5V ± 10%	3.5 to 5.5	-40 to +105	Supports external clock input/ Bias generator built in/ EMS countermeasure built in	QFP56	✓	YES
ML9476	16	—	—	48	64	—	—	3V ± 10%/ 5V ± 10%	3.5 to 5.5	-40 to +105	Supports external clock input/ Bias generator built in/ EMS countermeasure built in	TQFP48	✓	YES
ML9477	32	—	—	96	128	—	—	3V ± 10%/ 5V ± 10%	3.5 to 5.5	-40 to +105	Supports external clock input/ Bias generator built in/ EMS countermeasure built in	TQFP48	✓	YES
ML9484	50	50	100	150	200	—	—	2.7 to 5.5	4.5 to 5.5	-40 to +105	Supports external clock input/ Bias generator built in	TQFP64	✓	YES

LCD Controller Drivers(Gold Bump Product)														
ML9480	40	40	80	120	160	—	65/75/85/95/ 130/150/170/190 command switching	2.7 to 5.5	4.5 to 5.5	-40 to +105	Supports external clock input/ Bias generator built in/ EMS countermeasure built in/ No external parts	Au bump chip	✓	YES
ML9478C	80	80	160	240	320	—	65/75/85/95 command switching	2.7 to 5.5	4.5 to 5.5	-40 to +105	Supports external clock input/ Bias generator built in/ EMS countermeasure built in/ No external parts	Au bump chip	✓	YES
ML9479E	160	160	320	480	640	—	65/75/85/95 command switching	2.7 to 5.5	4.5 to 5.5	-40 to +105	Supports external clock input/ Bias generator built in/ EMS countermeasure built in/ No external parts	Au bump chip	✓	YES
ML9488	80	80	160	240	320	—	130/150/170/190 command switching	2.7 to 5.5	4.5 to 5.5	-40 to +105	Supports external clock input/ Bias generator built in	Au bump chip	✓	YES
ML9489	160	160	320	480	640	—	130/150/170/190 command switching	2.7 to 5.5	4.5 to 5.5	-40 to +105	Supports external clock input/ Bias generator built in	Au bump chip	✓	YES

*1: A check mark of halogen free support means that we will be able to ship out the halogen free products. For details, please inquire to the sales.
 *2: Please inquire to the sales for AEC-Q100.

VFD Driver Series

Anode/Grid Drivers for VFD

(LAPIS Semiconductor products)

VFD Drivers									
Part No.	No. of Driver Output	Driving Target	VFD Driving Voltage (V)	Power Supply Type	Operating Temperature (°C)	Feature	Package	Halogen Free Support ^{*1}	Automotive Grade ^{*2}
ML9271	48	Anode/Grid	18	Positive supply	-40 to +105	Cascade connection	QFP64-P-1414-0.80	—	YES
ML9272	40	Anode/Grid	65	Positive supply	-40 to +105	Cascade connection	SSOP60	✓	YES

*1: A check mark of halogen free support means that we will be able to ship out the halogen free products. For details, please inquire to the sales.
 *2: Please inquire to the sales for AEC-Q100.

Controller Drivers for Character VFD

(LAPIS Semiconductor products)

VFD Controller Drivers								
Part No.	Display Pixels	VFD Driving Voltage (V)	Power Supply Type	Operating Temperature (°C)	Feature	Package	Halogen Free Support ^{*1}	Automotive Grade ^{*2}
ML9208-xxGA	5 × 7 dots	V _{DD} -42	Negative supply	-40 to +85	3-bit gradation	QFP64-1414-0.80	✓	—
ML9208-xxMB	5 × 7 dots	V _{DD} -42	Negative supply	-40 to +85	3-bit gradation	SSOP64	—	—
ML9208A-xxGA	5 × 7 dots	V _{DD} -42	Negative supply	-40 to +85	4-bit gradation	QFP64	✓	—
ML9208A-xxTB	5 × 7 dots	V _{DD} -42	Negative supply	-40 to +85	4-bit gradation	TQFP64	✓	—
ML9209-xxGA	16 segs	V _{DD} -42	Negative supply	-40 to +85	4-bit gradation	QFP44	—	—
ML9289-xxGA	16 segs	42	Positive supply	-40 to +85	4-bit gradation	QFP44	✓	—
ML9289-xxTB	16 segs	42	Positive supply	-40 to +85	4-bit gradation	TQFP48	—	—
ML9286-xxGA	5 × 7 dots	80	Positive supply	-40 to +105	Multigrad function/ 8-bit gradation/ Cascade connection	QFP80-1414-0.65	✓	YES
ML9286-xxTB	5 × 7 dots	80	Positive supply	-40 to +105	Multigrad function/ 8-bit gradation/ Cascade connection	TQFP80-1212-0.50	✓	YES

*1: A check mark of halogen free support means that we will be able to ship out the halogen free products. For details, please inquire to the sales.
 *2: Please inquire to the sales for AEC-Q100.

Controller Drivers for Low Duty VFD

(LAPIS Semiconductor products)

VFD Controller Drivers								
Part No.	Max. No. of Driving Segments	VFD Driving Voltage(V)	Power Supply Type	Operating Temperature (°C)	Feature	Package	Halogen Free Support ^{*1}	Automotive Grade ^{*2}
ML9212GA	64 (1/2Duty) 96 (1/3Duty)	18	Positive supply	-40 to +85	10-bit gradation/ Cascade connection	QFP56	✓	YES
ML9213GP	112 (1/2Duty) 168 (1/3Duty)	18	Positive supply	-40 to +85	10-bit gradation/ Cascade connection	P-QFP80-1414-0.65	✓	YES

*1: A check mark of halogen free support means that we will be able to ship out the halogen free products. For details, please inquire to the sales.
 *2: Please inquire to the sales for AEC-Q100.

Car Clock Drivers

(LAPIS Semiconductor products)

Car Clock									
Part No.	Display Duty	VFD Driving Voltage (V)	Logic Supply Voltage (V)	Operating Temperature (°C)	Supply Current (Max.)(mA)	No. of Digit	Package	Halogen Free Support ^{*1}	Automotive Grade ^{*2}
ML9298	1/2	4.0 to 18	No need	-40 to +85	0.6	4digits×1line and col.	SSOP32	✓	YES
ML9098B	Static, 1/2	3.0 to 5.5	3.0 to 5.5	-40 to +105	0.6	4digits×1line and col., AM, PM	TQFP48	—	YES

*1: A check mark of halogen free support means that we will be able to ship out the halogen free products. For details, please inquire to the sales.
 *2: Please inquire to the sales for AEC-Q100.



Sensors & MEMS

CONTENTS

Hall ICs	P. A88
Omnipolar Detection Hall ICs	P. A88
Omnipolar Detection Hall ICs with Polarity Discrimination (Polarity Detection for Both S and N Features Dual Outputs)	P. A88
Bipolar Latch Hall IC	P. A88
Ambient Light Sensor ICs	P. A88
Analog Current Output type Ambient Light Sensor ICs	P. A88
Digital 16bit Serial Output type Ambient Light Sensor ICs	P. A88
Color Sensor ICs	P. A88
Digital 16bit Serial Output type Color Sensor ICs	P. A88
Optical Sensor for Heart Rate Monitor ICs ..	P. A88
Optical Sensor for Heart Rate Monitor ICs	P. A88
Pressure Sensor ICs	P. A89
Digital Pressure Sensor ICs with Built-in Temperature Compensation Function	P. A89
Temperature Sensor ICs	P. A89
Analog Output Temperature Sensor IC	P. A89
Digital Output Temperature Sensor IC	P. A89
Low Power Thermostat Output Temperature Sensor IC	P. A89
Amplifier for Human Body Detector IC ..	P. A89
Pyroelectric Infrared Sensor Amplifier	P. A89
Switch Controller ICs	P. A89
Capacitive Switch Controller ICs	P. A89
Touch Screen Controller ICs	P. A89
Resistive type	P. A89
Touch Screen I/F LSIs Supporting SPI/I ² C (LAPIS Semiconductor products)	P. A89
Accelerometers	P. A90
3-Axis Accelerometers (Kionix products)	P. A90
6-Axis Combo Sensors	P. A90
3-Axis Accelerometer + 3-Axis Gyroscope (Kionix products)	P. A90
3-Axis Accelerometer + 3-Axis Magnetometer (Kionix products)	P. A90
Infrared Image Sensor	P. A90
Infrared(IR) Sensor (LAPIS Semiconductor products)	P. A90

Hall ICs

Omnipolar Detection Hall ICs Detects S- or N-pole Magnetic Fields and Turns the Output ON (active Low).

Part No.	Supply Voltage (V)	Operate Point(mT)		Period (ms)	Current Consumption (Avg.)(μ A)	Output	Operating Temperature (°C)	Package (mm)
		S-pole	N-pole					
BU52092GWZ	1.65 to 3.6	+2.4	-2.4	50	4.4	CMOS	-40 to +85	UCSP35L1 (0.8×0.8)H=0.4 Max.
BU52055GWZ	1.65 to 3.6	+4.1	-4.1	50	5	CMOS	-40 to +85	UCSP35L1 (0.8×0.8)H=0.4 Max.
BU52054GWZ	1.65 to 3.6	+6.3	-6.3	50	5	CMOS	-40 to +85	UCSP35L1 (0.8×0.8)H=0.4 Max.
BU52095GWZ	1.65 to 3.6	+9.5	-9.5	50	4.4	CMOS	-40 to +85	UCSP35L1 (0.8×0.8)H=0.4 Max.
BU52097GWZ	1.65 to 3.6	+15.0	-15.0	50	4.4	CMOS	-40 to +85	UCSP35L1 (0.8×0.8)H=0.4 Max.
BU52098GWZ	1.65 to 3.6	+24.0	-24.0	50	4.4	CMOS	-40 to +85	UCSP35L1 (0.8×0.8)H=0.4 Max.
New BU52792GWZ	2.7 to 5.5	+2.4	-2.4	50	3.2	CMOS	-40 to +85	UCSP35L1 (0.8×0.8)H=0.4 Max.
BD7411G	4.5 to 5.5	+3.4	-3.4	—	2.0(mA)	CMOS	-40 to +85	SSOP5

Omnipolar Detection Hall ICs with Polarity Discrimination (Polarity Detection for Both S and N Features Dual Outputs) Features 2 Outputs to Discriminate Between N- and S-pole Detection.

BU52272NUZ	1.65 to 3.6	+2.4	-2.4	50	4.4	CMOS (2 Outputs : S, N pole)	-40 to +85	VSON04Z1114A (1.1×1.4)H=0.4 Max.
New BU52072GWZ	1.65 to 3.6	+2.4	-2.4	50	4.4	CMOS (2 Outputs : S, N pole)	-40 to +85	UCSP35L1 (0.8×0.8)H=0.4 Max.
BU52273NUZ	1.65 to 3.6	+4.1	-4.1	50	4.4	CMOS (2 Outputs : S, N pole)	-40 to +85	VSON04Z1114A (1.1×1.4)H=0.4 Max.
New BU52073GWZ	1.65 to 3.6	+4.1	-4.1	50	4.4	CMOS (2 Outputs : S, N pole)	-40 to +85	UCSP35L1 (0.8×0.8)H=0.4 Max.
BU52274NUZ	1.65 to 3.6	+6.3	-6.3	50	4.4	CMOS (2 Outputs : S, N pole)	-40 to +85	VSON04Z1114A (1.1×1.4)H=0.4 Max.
New BU52074GWZ	1.65 to 3.6	+6.3	-6.3	50	4.4	CMOS (2 Outputs : S, N pole)	-40 to +85	UCSP35L1 (0.8×0.8)H=0.4 Max.
BU52075GWZ	1.65 to 3.6	+9.5	-9.5	50	5	CMOS (2 Outputs : S, N pole)	-40 to +85	UCSP35L1 (0.8×0.8)H=0.4 Max.
BU52077GWZ	1.65 to 3.6	+15.0	-15.0	50	5	CMOS (2 Outputs : S, N pole)	-40 to +85	UCSP35L1 (0.8×0.8)H=0.4 Max.
BU52177GXZ	1.65 to 3.6	+15.0	-15.0	50	5	CMOS (2 Outputs : S, N pole)	-40 to +85	XCSP30L1 (0.65×0.65)H=0.33 Max.
BU52078GWZ	1.65 to 3.6	+24.0	-24.0	50	5	CMOS (2 Outputs : S, N pole)	-40 to +85	UCSP35L1 (0.8×0.8)H=0.4 Max.

Bipolar Latch Hall IC Detects Turn of Pole (S→N or N→S)(N-pole→S-pole : Out put High→Low S-pole→N-pole : Out put Low→High)

BU52040HFV	1.65 to 3.3	+3.0	-3.0	0.5	200	CMOS	-40 to +85	HVSOF5
------------	-------------	------	------	-----	-----	------	------------	--------

Ambient Light Sensor ICs

Analog Current Output type Ambient Light Sensor ICs

Part No.	Supply Voltage (V)	Sensitivity Variations (%)	Illuminance Measurement Range (lx)	High Sensitivity	IR Cut	I/F	Operating Temperature (°C)	Package
BH1603FVC	2.4 to 5.5	±15	0 to 100,000	—	—	Linear Current Output (Source)	-40 to +85	WSOF6
BH1620FVC	2.4 to 5.5	±15	0 to 100,000	—	—	Linear Current Output (Source)	-40 to +85	WSOF5
BH1680FVC	2.4 to 5.5	±15	0 to 50,000	✓	✓	Linear Current Output (Source)	-40 to +85	WSOF5
BH1682FVC	2.3 to 5.5	±3 μ A	0 to 55,000	—	✓	Logarithmic Current Output (Source)	-40 to +80	WSOF5

Digital 16bit Serial Output type Ambient Light Sensor ICs

BH1721FVC	2.4 to 3.6	±15	0 to 65,000	—	—	I ² C	-40 to +85	WSOF5
BH1730FVC	2.4 to 3.6	±15	0 to 65,000 (1/128 lx step)	✓	—	I ² C	-40 to +85	WSOF6
BH1726NUC	2.3 to 3.6	±15	0 to 30,000 (1/512 lx step)	✓	✓	I ² C	-40 to +85	WSON008X2120

Color Sensor ICs

Digital 16bit Serial Output type Color Sensor ICs

Part No.	Supply Voltage (V)	λ (nm)					Illuminance Measurement Range (lx)	High Sensitivity	IR Cut	I/F	Operating Temperature (°C)	Package
		Red	Green	Blue	Clear	IR						
BH1745NUC	2.3 to 3.6	620	540	460	585	—	0 to 40,000	✓	✓	I ² C	-40 to +85	WSON008X2120
New BH1747NUC	2.3 to 3.6	630	540	460	585	825	0 to 80,000	✓	✓	I ² C	-40 to +85	WSON008X2120

Optical Sensor for Heart Rate Monitor ICs

Optical Sensor for Heart Rate Monitor ICs

Part No.	Analog Supply Voltage (V)	IO Supply Voltage (V)	Sampling Rate (Hz)	Red Light, IR Cut	I/F	Operating Temperature (°C)	Package (mm)
BH1790GLC	2.5 to 3.6	1.7 to 3.6	32/64	✓	I ² C	-20 to +85	WLG A010V28 (2.8×2.8)H=1.0 Max.
New BH1792GLC	2.5 to 3.6	1.7 to 3.6	32/128/256/512/1024	✓	I ² C	-20 to +85	WLG A010V28 (2.8×2.8)H=1.0 Max.

Pressure Sensor ICs

Digital Pressure Sensor ICs with Built-in Temperature Compensation Function

New

Part No.	Supply Voltage (V)	Pressure Range (hPa)	Relative Pressure Accuracy (hPa)	Absolute Pressure Accuracy (hPa)	Average Current Consumption (μA)	I/F	Operating Temperature (°C)	Package (mm)
BM1383AGLV	1.7 to 3.6	300 to 1,100	±0.12	±1	3.0	I ² C	-40 to +85	CLGA12V025M (2.5×2.5)H=1.0 Max.
BM1386GLV	1.7 to 3.6	300 to 1,300	±0.12	±1	3.0	I ² C	-40 to +85	CLGA10V020A (2.0×2.0)H=1.0 Max.

Temperature Sensor ICs

Analog Output Temperature Sensor IC

Part No.	Supply Voltage (V)	Temperature Accuracy(°C)		Temperature Sensitivity(mV/°C)	Output Voltage(V) (Ta=+30°C, VDD=3V)	Supply Current (μA)	Operating Temperature (°C)	Package
		Ta=+30°C	Ta=-30, +100°C					
BD1020HFV	2.4 to 5.5	±1.5	±2.5	-8.2	1.3	4.0	-30 to +100	HVSOF5

Digital Output Temperature Sensor IC

Part No.	Supply Voltage (V)	Temperature Accuracy(°C) Ta=-20 to +85°C	Current Consumption (μA)	I/F	Operating Temperature (°C)	Package
BH1900NUX	2.7 to 3.6	±3.0	75.0	I ² C	-30 to +95	VSON008X2030

Low Power Thermostat Output Temperature Sensor IC

Part No.	Supply Voltage (V)	Detect Temperature (°C)	Detect Temperature Accuracy (°C)	Current Consumption (Operation/Power down) (μA)	Output Type		Operating Temperature (°C)	Package
					Type	Active		
BDJxxx0HFV Series	2.4 to 5.5	60/70/80	±2.5	7.5/0.3	Open Drain	L	-30 to +100	HVSOF5

*Low Power Thermostat Output Temperature Sensor ICs : Detection temperature (xxx : 055, 060, 065, 070, 080) is applied in the BDJxxx0HFV of part No.

Amplifier for Human Body Detector IC

Pyroelectric Infrared Sensor Amplifier

Part No.	Supply Voltage (V)	DRAIN Voltage (V)	AMP1/AMP2 Gain (dB)	Output Type	Package
BD9251FV	2.97 to 6	2.3	46 Max.	Analog/CMOS	SSOP-B14

Switch Controller ICs

Capacitive Switch Controller ICs

New

Part No.	Supply Voltage (V)	Cap Switch (ch)	LED_Driver (ch)	LED_PWM Control	Matrix Control	I/F	MCU (bit)	Program Memory	Intermittent Motion	Package
BU21170MUV	3.0 to 5.5	5	5	✓	—	I ² C	32	ROM	—	VQFN020V4040
BU21079F	3.0 to 5.5	8	—	—	4×4	I ² C	32	ROM	✓	SOP16
BU21077MUV	2.7 to 5.5	8	—	—	Adjustable	I ² C	32	RAM	✓	VQFN020V4040
BU21072MUV	3.0 to 5.5	10	6	✓	4×4	I ² C	32	ROM	—	VQFN024V4040
BU21078MUV	3.0 to 5.5	12	8	✓	6×6	I ² C	32	ROM	—	VQFN028V5050
BU21078FV	3.0 to 5.5	12	8	✓	6×6	I ² C	32	ROM	—	SSOP-B28
BU21180FS	3.0 to 5.5	20	—	—	—	I ² C	32	ROM	—	SSOP-A32

Touch Screen Controller ICs

Resistive type

New

Part No.	Supply Voltage (V)	MCU (bit)	Resolution	Touch Detection	Stand-by Current (μA)	Active Current (mA)	Host I/F	Operating Temperature (°C)	Package (mm)	Automotive Grade AEC-Q100
BU21029MUV	1.65 to 3.6	—	4096×4096	2 point/Single	100	0.8	I ² C	-20 to +85	VQFN020V4040	—
BU21029GUL	1.65 to 3.6	—	4096×4096	2 point/Single	100	0.8	I ² C	-20 to +85	VCSP50L2 (2.0×2.0, t=0.55)	—
BU21028FV-M	2.7 to 3.6	—	4096×4096	2 point/Single	100	0.8	I ² C	-40 to +85	SSOP-B20	YES
BU21023MUV	2.7 to 3.6	8	1024×1024	2 point/Single	60	4	I ² C/SPI	-20 to +85	VQFN028V5050	—
BU21023GUL	2.7 to 3.6	8	1024×1024	2 point/Single	60	4	I ² C/SPI	-20 to +85	VCSP50L2 (2.6×2.6, t=0.55)	—
BU21024FV-M	2.7 to 3.6	8	1024×1024	2 point/Single	60	4	I ² C/SPI	-40 to +85	SSOP-B28	YES
BU21027MUV	2.7 to 3.6	32	4096×4096	2 point/Single	70	8	I ² C	-20 to +85	VQFN020V4040	—
BU21025GUL	1.65 to 3.6	—	4096×4096	Single	0.8	0.12	I ² C	-30 to +85	VCSP50L2 (2.0×1.5, t=0.55)	—
BU21026MUV	1.65 to 3.6	—	4096×4096	Single	0.8	0.12	I ² C	-30 to +85	VQFN020V4040	—

Touch Screen I/F LSIs Supporting SPI/I²C

(LAPIS Semiconductor products)

Part No.	Supply Voltage (V)	MCU	Resolution	Touch Detection	Stand-by Current (μA)	Active Current (mA)	Host I/F	Operating Temperature (°C)	Package (mm)	Automotive Grade
ML26700CGD	2.7 to 3.6	—	4096×4096	Single	30	0.42	I ² C	-40 to +85	WQFN12 3.0×3.0, t=0.55	YES
ML26700SGD	2.7 to 3.6	—	4096×4096	Single	30	0.56	SPI	-40 to +85	WQFN12 3.0×3.0, t=0.55	YES

Accelerometers

(Kionix products)

3-Axis Accelerometers							
Part No.	Axis	Full-Scale Range	I/F Output	Current Consumption (µA)	Size, Pins, and Package Type	Features	Automotive Grade AEC-Q100
KX122-1037	3	User-selectable 2g, 4g, 8g	Digital SPI/I ² C	0.9 to 145	2 × 2 × 0.9mm, 12pin, LGA	2KB FIFO/FILO, Wide range of ODRs from 0.781Hz to 25.6kHz, Directional Tap/Double-Tap™, Free fall, Orientation Detection	—
New KX124-1051	3	User-selectable 2g, 4g, 8g	Digital SPI/I ² C	0.9 to 145	3 × 3 × 0.9mm, 16pin, LGA	2KB FIFO/FILO, Wide range of ODRs from 0.781Hz to 25.6kHz, Directional Tap/Double-Tap™, Free fall, Orientation Detection	—
New KX126-1063	3	User-selectable 2g, 4g, 8g	Digital SPI/I ² C	0.9 to 145	2 × 2 × 0.9mm, 12pin, LGA	Pedometer function, 2KB FIFO/FILO, Wide range of ODRs from 0.781Hz to 25.6kHz, Directional Tap/Double-Tap™, Free fall, Orientation Detection	—
New KXCJB-1041	3	User-selectable 2g, 4g, 8g	Digital I ² C	10 to 135	3 × 3 × 0.45mm, 10pin, LGA	Low Current Consumption, User-configurable wakeup function, Ultra thin type	—
New KX112-1042	3	User-selectable 2g, 4g, 8g	Digital SPI/I ² C	0.9 to 145	2 × 2 × 0.6mm, 12pin, LGA	2KB FIFO/FILO, Wide range of ODRs from 0.781Hz to 25.6kHz, Directional Tap/Double-Tap™, Free fall, User-configurable wakeup function, Thin type	—
New KXTJ3-1057	3	User-selectable 2g, 4g, 8g, 16g	Digital I ² C	0.9 to 155	2 × 2 × 0.9mm, 12pin, LGA	User-configurable wakeup function	—
New KX224-1053	3	User-selectable 8g, 16g, 32g	Digital SPI/I ² C	0.9 to 145	3 × 3 × 0.9mm, 16pin, LGA	2KB FIFO/FILO, Wide range of ODRs from 0.781Hz to 25.6kHz, Mechanical resonance frequency(−3dB)6kHz(xy), 3.6kHz(z)	—
New KX222-1054	3	User-selectable 8g, 16g, 32g	Digital SPI/I ² C	0.9 to 145	2 × 2 × 0.9mm, 12pin, LGA	2KB FIFO/FILO, Wide range of ODRs from 0.781Hz to 25.6kHz, Mechanical resonance frequency(−3dB)6kHz(xy), 3.6kHz(z)	—
KXTC9 series	3	2g to 6g	Analog	170 to 310	3 × 3 × 0.9mm, 10pin, LGA	Factory Programmable Internal Low Pass Filter	—
☆KX220 series	3	up to 40g	Analog	170 to 310	3 × 3 × 0.9mm, 10pin, LGA	Factory Programmable Internal Low Pass Filter	—
☆KX123-6000	3	User-selectable 2g, 4g, 8g	Digital SPI/I ² C	10 to 145	3 × 3 × 0.9mm, 16pin, LGA	AEC-Q100 qualified, Operating Temperature −40 to 85°C, 2KB FIFO/FILO, Wide range of ODRs from 0.781Hz to 25.6kHz, Directional Tap/Double-Tap™, Free fall, Orientation Detection	YES*

*For Automotive Non-Safety Directional Tap/Double-Tap™ is a trademark of Kionix.

☆ : Under Development

6-Axis Combo Sensors

(Kionix products)

3-Axis Accelerometer + 3-Axis Gyroscope										
Part No.	Axis	Gyroscope Full-Scale Range	Accelerometer Full-Scale Range	Accelerometer Sensitivity	Resolution	Size, No. of Pins, Package	I/F Output	Wakeup	Operating Temperature (°C)	V _{CC} (V)
☆KXG07	6	±2048, ±1024, ±512, ±256, ±128, ±64°/Sec	2g, 4g, 8g, 16g	16384(±2g), 8192(±4g), 4096(±8g), 2048(±16g), Counts/g	16	3 × 3 × 0.9mm, 16pin, LGA	Digital I ² C/SPI	Yes	−40 to +85	1.8 to 3.6
☆KXG08	6	±2048, ±1024, ±512, ±256, ±128, ±64°/Sec	2g, 4g, 8g, 16g	16384(±2g), 8192(±4g), 4096(±8g), 2048(±16g), Counts/g	16	2.5 × 3 × 0.95mm, 14pin, LGA	Digital I ² C/SPI	Yes	−40 to +85	1.8 to 3.6

3-Axis Accelerometer + 3-Axis Magnetometer								
Part No.	Axis	Accelerometer Full-Scale Range	I/F Output	Current (µA)	Magnetometer Range	Operating Temperature (°C)	Size, Pins, and Package Type	Features
New KMX62-1031	6	User-selectable 2g, 4g, 8g, 16g	Digital I ² C	10 to 395	±1,200µT	−40 to +85	3 × 3 × 0.9mm, 16pin, LGA	E-compass Solution, Magnetic field change, Free fall

☆ : Under Development

Infrared Image Sensor

(LAPIS Semiconductor products)

Infrared(IR) Sensor										
Part No.	Feature	Pixel	Measurement Range (°C)	Temperature Resolution (without Lens) (°C)	Output Type	Read Speed	Supply Voltage (V)	Operating Temperature (°C)	Package	Halogen Free Support
ML8540	2000 pixels thermopile type Thermal image sensor	47row × 48column 2256 pixels	−30 to +300(Variable)	0.5	Analog	6FPS	4.5 to 5.5	−30 to +85	C-QFN24	✓

A check mark of halogen free support means that we will be able to ship out the halogen free products. For details, please inquire to the sales.



Communication LSI

CONTENTS

Digital Terrestrial Broadcasting Reception LSI	P. A92
Japanese System(ISDB-T)(LAPIS Semiconductor products)	P. A92
Wireless Communication LSIs	P. A92
IEEE802.15.4(LAPIS Semiconductor products)	P. A92
Bluetooth®(LAPIS Semiconductor products)	P. A92
Specified Low Power Radio(Sub-GHz band radio) (LAPIS Semiconductor products)	P. A92
LPWA(LAPIS Semiconductor products)	P. A93
MCU Included Specified Low Power Radio(Sub-GHz band radio) System LSI(LAPIS Semiconductor products)	P. A93
VoIP LSIs	P. A93
VoIP CODEC(LAPIS Semiconductor products)	P. A93
Echo Canceller LSIs	P. A93
Echo Canceller(LAPIS Semiconductor products)	P. A93
Echo Canceller/Noise Canceller(LAPIS Semiconductor products)	P. A93
CODEC LSIs	P. A94
PCM CODEC(LAPIS Semiconductor products)	P. A94
ADPCM CODEC(LAPIS Semiconductor products)	P. A94
Car Communication LSIs	P. A94
FM Data Broadcast Reception LSIs(LAPIS Semiconductor products)	P. A94

Digital Terrestrial Broadcasting Reception LSI

Japanese System(ISDB-T)
(LAPIS Semiconductor products)

RF tuner + OFDM Demodulator for 1 Segment Digital Terrestrial Broadcasting											
Part No.	Transmission Standard	Feature				Supply Voltage (V)	Power Consumption	Operating Temperature(°C)	Package	Halogen Free Support*1	Automotive Grade*2
ML7147	ISDB-T	Compliant to One-Seg broadcasting of ISDB-T (ARIB STD-B31) digital terrestrial television broadcasting. RF tuner, OFDM demodulate, error correction function. Serial, parallel TS output.				2.7 to 3.0 1.5 to 3.6 1.1 to 1.3	70mW (at 1seg. reception, include RF)	-40 to +90	WQFN80	✓	YES

*1: A check mark of halogen free support means that we will be able to ship out the halogen free products. For details, please inquire to the sales.
 *2: Please inquire to the sales for AEC-Q100.

Wireless Communication LSI

IEEE802.15.4
(LAPIS Semiconductor products)

Serial Interface Transceiver LSI												
Part No.	Supported Standard	Frequency Band	Supply Voltage (V)	Modulation Method	Function	Control Interface	Transmission Rate (Kbps)	Transmission Output (dBm)	Reception Sensitivity (dBm)	Operating Temperature (°C)	Package	Halogen Free Support*2
ML7275	IEEE802.15.4	2.4GHz ISM Band	1.8 to 3.6	O-QPSK	IEEE802.15.4-2003 PHY/MAC (Not full MAC function)	Synchronous serial or UART	250	-45 to 0 (3 step)	-92*	-40 to +85	WQFN40	✓

*1: PER(Packet Error Rate)<1%
 *2: A check mark of halogen free support means that we will be able to ship out the halogen free products. For details, please inquire to the sales.

Bluetooth®
(LAPIS Semiconductor products)

Bluetooth® Low Energy LSI												
Part No.	Supported Standard	Frequency Band	Supply Voltage (V)	Modulation Method	Function	Control Interface	Transmission Rate (Mbps)	Transmission Output (dBm)	Reception Sensitivity (dBm)	Operating Temperature (°C)	Package	Halogen Free Support*4
ML7105-002	Bluetooth® core spec. v4.0 (Single mode)	2.4GHz ISM band	1.6 to 3.6	GFSK	Role : Master/Slave Connectable device(s) : 1 device	(BACI*1)SPI (HCI*2)UART	1	0/-6/-12/-18	-86*3	-20 to +70	WQFN32	✓
ML7125-001	Bluetooth® core spec. v4.1 (Single mode)	2.4GHz ISM band	1.6 to 3.6	GFSK	Role : Master/Slave Connectable device(s) : 2 devices	(BACI*1)SPI (HCI*2)UART	1	+4/0/-6/-12/-18	-85*3	-20 to +75	WCSP67	✓
ML7125-002	Bluetooth® core spec. v4.1 (Single mode)	2.4GHz ISM band	1.6 to 3.6	GFSK	Role : Slave only Connectable device(s) : 1 device	UART	1	+4/0/-6/-12/-18	-85*3	-20 to +75	WCSP67	✓

Bluetooth® is a registered trademark of Bluetooth®SIG.
 *1: BACI(Bluetooth Application Controller Interface) : Lapis Semiconductor proprietary host interface *2: HCI(Host Control Interface) : Bluetooth standard interface *3: BER(Bit Error Rate)<0.1% equivalent
 *4: A check mark of halogen free support means that we will be able to ship out the halogen free products. For details, please inquire to the sales.

Specified Low Power Radio(Sub-GHz band radio)
(LAPIS Semiconductor products)

UHF Transmitter LSI												
Part No.	Supported Standard	Frequency Band	Supply Voltage (V)	Modulation Method	FEC Mode	Control Interface	Transmission Rate	Transmission Output (dBm)	Reception Sensitivity	Operating Temperature (°C)	Package	Halogen Free Support*2
ML7386	ARIB STD-T67 RCRSTD-30	426MHz band	1.8 to 3.6	2-FSK MSK	—	Synchronous serial(Control) DI(DATA)	2.4kbps	10mW	—	-25 to +85	WQFN28	✓
ML7386B							4.8kbps	1mW/10mW				
UHF Transceiver LSI												
ML7066[J]	ARIB STD-T67 RCRSTD-30	426MHz band 429MHz band	2.1 to 3.6	2-FSK	—	Synchronous serial(Control) DIO(DATA)	1.2kbps, 2.4kbps 4.8kbps[NRZ] (3-step setting function)	1mW/10mW	-116dBm [BER<1%]*1	-25 to +65	WQFN48	✓
ML7396D	ARIB STD-T108 EN300-220	750 to 960MHz	1.8 to 3.6	2-(G)FSK (G)MSK	IEEE 802.15.4g compliant	Synchronous serial (Control · DATA) DIO(DATA)	to 50kbps 100kbps 150kbps 200kbps 400kbps	1mW/10mW/20mW	-107dBm [100kbps BER=0.1%]*1	-40 to +85	WQFN40	✓
ML7396A	FCC part15.247/249								-106dBm [100kbps BER=0.1%]*1			
ML7344J	ARIB STD-T67 RCRSTD-30	160 to 510MHz	1.8 to 3.6	2-(G)FSK (G)MSK	—	Synchronous serial(Control) DIO(DATA)	to 15kbps	1mW/10mW/20mW	-117dBm [4.8kbps BER=0.1%]*1	-40 to +85	WQFN32	✓
ML7344C	Q/GDW374.3		3.3 to 3.6 (100mW)					20mW/100mW				
ML7406	EN300-220 EN13757-4 : 2011	750 to 960MHz	1.8 to 3.6	2-(G)FSK (G)MSK	—	Synchronous serial(Control) DIO(DATA)	to 500kbps	1mW/10mW/20mW	-106dBm [100kbps BER=0.1%]*1	-40 to +85	WQFN32	✓
ML7345	ARIB STD-T67 ARIB STD-T108 RCR STD-30 EN300-220 EN13757-4 : 2013	160 to 960MHz	1.8 to 3.6	2-(G)FSK (G)MSK 4-(G)FSK	—	Synchronous serial(Control) DIO(DATA)	to 100kbps	1mW/10mW/20mW	-123dBm [2.4kbps BER=1%]*1	-40 to +85	WQFN32	✓
ML7345D	ARIB STD-T67 ARIB STD-T108 RCR STD-30 EN300-220 EN13757-4:2013	315 to 960MHz	1.8 to 3.6	2-(G)FSK (G)MSK 4-(G)FSK	—	Synchronous serial(Control) DIO(DATA)	to 100kbps	1mW/10mW/20mW	-119.5dBm [100kbps BER=1%]*1	-40 to +85	WQFN32	✓
ML7345C	Q/GDW374.3	470 to 510MHz	3.3 to 3.6 (100mW)	2-(G)FSK (G)MSK 4-(G)FSK	—	Synchronous serial(Control) DIO(DATA)	to 100kbps	20mW/100mW	-123dBm [2.4kbps BER=1%]*1	-40 to +85	WQFN32	✓

[J]: This LSI is limited to the market in Japan. *1: BER means Bit Error Rate.
 *2: A check mark of halogen free support means that we will be able to ship out the halogen free products. For details, please inquire to the sales.

LPWA

(LAPIS Semiconductor products)

UHF Transceiver LSI												
Part No.	Supported Standard	Frequency Band	Supply Voltage (V)	Modulation Method	FEC Mode	Control Interface	Transmission Rate	Transmission Output (dBm)	Reception Sensitivity	Operating Temperature (°C)	Package	Halogen Free Support ^{*3}
New ML7404	ARIB STD-T67 ARIB STD-T108 RCR STD-30 EN300-220 EN13757-4:2013 Sigfox®(Rev 2.E) IEEE802.15.4k	315 to 960MHz	1.8 to 3.6	2-(G)FSK (G)MSK 4-(G)FSK BPSK DSSS	IEEE 802.15.4k compliant	Synchronous serial(Control) DIO(DATA)	to 101kbps (uFSK) 80k to 200kcps (DSSS)	1mW/ 10mW/ 20mW	- 119.5dBm [2.4kbps] BER=1% ^{*1} (uFSK) - 121dBm [200kcps, SF=64, PER=1%] ^{*2} (DSSS)	- 40 to + 85	WQFN32	✓

Sigfox® is a registered trademark of SIGFOX S.A.
 *1: BER means Bit Error Rate. *2: PER means Packet Error Rate.
 *3: A check mark of halogen free support means that we will be able to ship out the halogen free products. For details, please inquire to the sales.

MCU Included Specified Low Power Radio(Sub-GHz band radio)System LSI

(LAPIS Semiconductor products)

UHF Transceiver LSI												
Part No.	Supported Standard	Frequency Band	Supply Voltage (V)	Modulation Method	CPU Core	Memory Resources	Transmission Rate	Transmission Output (dBm)	Reception Sensitivity	Operating Temperature (°C)	Package	Halogen Free Support ^{*2}
New ML7416N	ARIB STD-T108	750 to 960MHz	1.8 to 3.6	2-(G)FSK (G)MSK	Cortex®-M0+	FLASH512KB, RAM64KB	to 50kbps 100kbps 150kbps 200kbps 400kbps	1mW/ 10mW/ 20mW	- 106dBm [100kbps] BER = 0.1% ^{*1}	-40 to +85	BGA81	✓

Cortex® is a registered trademark of ARM Limited(or it's child company) in the EU and the other companies.
 *1: BER means Bit Error Rate. *2: A check mark of halogen free support means that we will be able to ship out the halogen free products. For details, please inquire to the sales.

VoIP LSIs

VoIP CODEC

(LAPIS Semiconductor products)

VoIP CODEC									
Part No.	Speech Compression Method	Channel number	Operating Frequency (MHz)	Supply Voltage (V)	Supply Current (Max.)	Operating Temperature (°C)	Package	Halogen Free Support ^{*1}	
ML7074-003	G.729.A/G.726/G.711	1	4.096	3.0 to 3.6	65mA	-20 to +60	QFP64	✓	
ML7074-004	G.729.A/G.711		4.096	3.0 to 3.6	65mA		QFP64	✓	
ML7204-003	G.729.A/G.711		12.288	3.0 to 3.6	65mA		QFP64	✓	
2ch VoIP CODEC									
ML7214A-001	G.711	2	12.288	3.0 to 3.6	65mA	-20 to +60	TQFP100	✓	
4ch VoIP CODEC									
ML7224A-001	G.711	4	12.288	3.0 to 3.6	125mA	-20 to +60	LQFP176	✓	

*1: A check mark of halogen free support means that we will be able to ship out the halogen free products. For details, please inquire to the sales.

Echo Canceller LSIs

Echo Canceller

(LAPIS Semiconductor products)

Dual Echo Canceller + ADPCM Transcoder							
Part No.	Cancelable Echo Delay Time	Voice Signal Interface	Supply Voltage (V)	Operating Frequency (MHz)	Notes	Package	Halogen Free Support ^{*1}
ML7202-001	64ms/channel	μ-law, A-law	3.0 to 3.6	19.2	Dual echo canceller + ADPCM transcoder Tone Gen/Det., VOX, Gain Control, Time Slot Assignment, etc.	TQFP64	✓

*1: A check mark of halogen free support means that we will be able to ship out the halogen free products. For details, please inquire to the sales.

Echo Canceller/Noise Canceller

(LAPIS Semiconductor products)

Dual Echo Canceller/Noise Canceller with Dual CODEC							
Part No.	Cancelable Echo Delay Time	Voice Signal Interface	Supply Voltage (V)	Operating Frequency (MHz)	Notes	Package	Halogen Free Support ^{*1}
ML7037-003	Acoustic side 64ms, Line side 20ms	Acoustic side : analog, Line side :analog, 16-bit linear, μ-law PCM	3.0 to 3.6	12.288	Dual echo canceller/noise canceller with dual CODEC Noise cancellation = 6 to 18dB	TQFP64	✓
Echo Canceller/Noise Canceller with Dual Wide-band CODEC							
ML7247-001	Acoustic side 64ms	Acoustic side : analog, Line side : analog, 16-bit linear	3.0 to 3.6	12.288	Echo canceller/Noise canceller with dual wide-band CODEC Noise cancellation = 1 to 45dB Sampling frequency = 8kHz or 16kHz	TQFP64	✓

*1: A check mark of halogen free support means that we will be able to ship out the halogen free products. For details, please inquire to the sales.

A
Communication LSI

CODEC LSIs

PCM CODEC

(LAPIS Semiconductor products)

Multifunction 2ch PCM CODEC													
Part No.	PCM Sign			Channel Number	Supply Voltage(V)	PCM Synchronous Type		Analog Output			Notes	Package	Halogen Free Support ^{*1}
	μ-law	A-law	14-bit linear			long	short	full swing	output load	differential			
ML7033-01	✓	✓	✓	2	4.75 to 5.25	✓	✓	3.4Vpp	20kΩ	—	Multifunction 2ch PCM CODEC	QFP64	✓
3V linear PCM CODEC													
ML7041	✓	✓	✓	1	2.4 to 3.3	✓	✓	2.6Vpp	8Ω	✓	3V linear PCM CODEC With tone generators regulators and I ² C I/F	TQFP48	✓
MSM7732A	✓	✓	✓	1	2.4 to 3.3	✓	✓	3.0Vpp	32Ω	✓	3V linear PCM CODEC With tone generators	TQFP48/BGA48	✓
3V 1ch PCM CODEC													
MSM7717-01	✓	✓	—	1	2.7 to 3.8	✓	—	2.0Vpp	600Ω	✓	3V 1ch PCM CODEC	SSOP20	—
3V 2ch PCM CODEC													
MSM7704-01	✓	✓	—	2	2.7 to 3.8	✓	—	2.0Vpp	1.2kΩ	—	3V 2ch PCM CODEC	SOP24	✓
5V 1ch PCM CODEC													
MSM7578V	✓	✓	—	1	4.75 to 5.25	✓	—	2.4Vpp	600Ω	—	5V 1ch PCM CODEC	SOP24/SSOP20	✓
5V 2ch PCM CODEC													
MSM7533V	✓	✓	—	2	4.75 to 5.25	✓	—	3.4Vpp	600Ω	—	5V 2ch PCM CODEC	SOP24	✓

*1: A check mark of halogen free support means that we will be able to ship out the halogen free products. For details, please inquire to the sales.

ADPCM CODEC

(LAPIS Semiconductor products)

ADPCM CODEC Compliant with G.726									
Part No.	PCM Interface	Operating Frequency (MHz)	Supply Voltage (V)	Analog Output	Supply Current (Max.)(mA)	Operating Temperature (°C)	Note	Package	Halogen Free Support ^{*1}
ML7029	μ-Law	10.368	2.7 to 3.6	1.3Vpp, 20kΩ	12	−25 to +70	ADPCM CODEC compliant with G.726	SSOP30	✓

*1: A check mark of halogen free support means that we will be able to ship out the halogen free products. For details, please inquire to the sales.

Car Communication LSIs

FM Data Broadcast Reception LSIs

(LAPIS Semiconductor products)

FM Data Reception Tuner								
Part No.	Feature	Supply Voltage (V)	Supply Current (Max.)(mA)	Operating Temperature (°C)	Package	Halogen Free Support ^{*1}	Automotive Grade ^{*2}	
ML7174[J]	FM VICS [®] tuner, FM multiplexing demodulate LSI for VICS [®] , Built-in BPF, frame memory, and VICS [®] descrambler, Frames A,B,C, SPI slave	3.0 to 3.6	85	−40 to +85	WQFN64	✓	YES	
ML7183[J]	FM VICS [®] tuner & Filter LSI, BPF, I ² C slave	3.0 to 3.6	75	−40 to +85	WQFN64	✓	YES	
FM Multiplexing Demodulate for VICS [®]								
ML7154[J]	VICS [®] compliant FM multiplexing demodulate LSI for VICS [®] , Built-in BPF, frame memory, and VICS [®] descrambler, Frames A,B,C, SPI slave	3.0 to 3.6	28	−40 to +85	WQFN64	✓	YES	
FM Multiplexing Demodulate for DARC [®]								
MSM9563	FM multiplexing demodulate LSI for DARC [®] , BPF&frame memory built-in, Frames A,B,C, 8bit BUS interface	3.0 to 3.6	28	−40 to +85	QFP44	✓	YES	

[J]: This LSI is limited to the market in Japan.

 VICS[®] is a registered trademark of Vehicle Information and Communication System Center.

 DARC[®] is a registered trademark of NHK Engineering System, Inc..

*1: A check mark of halogen free support means that we will be able to ship out the halogen free products. For details, please inquire to the sales.

*2: Please inquire to the sales for AEC-Q100.



Audio & Video

CONTENTS

Audio Amplifiers	P. A96
Speaker Amplifiers	P. A96
Headphone Amplifiers	P. A97
Others	P. A98
Audio Subsystems	P. A98
Line Amplifiers	P. A98
Isolation Amplifiers	P. A98
Audio Processors	P. A98
Analog Audio Processors	P. A98
AUDIO SoCs	P. A101
Media Decoders	P. A101
Video Amplifiers	P. A102
Composite Video Amplifiers	P. A102
Video Switches	P. A102
Others	P. A102
Isolation Amplifier	P. A102
Audio Converters	P. A103
Audio Codec	P. A103
Image Correction	P. A103
Image Correction ICs for Panel	P. A103
Video Encoders Built-in Image Correction	P. A103
Video LSIs	P. A103
Video Decoder(LAPIS Semiconductor products)	P. A103
Video Encoder(LAPIS Semiconductor products)	P. A103
Video Interface(LAPIS Semiconductor products)	P. A103
Display Controller Series for Small to Medium-Sized TFT LCD(LAPIS Semiconductor products)	P. A104

Audio Amplifiers

Speaker Amplifiers

Portable Amplifier 1.9W+1.9W Stereo Speaker Amplifier

Part No.	Supply Voltage (V)	Power Dissipation (W)	Quiescent Current (mA)	Standby Current (μA)	Voltage Gain (dB)	Output Power (W)	Distortion (%)	Output Noise Voltage (μVrms)	Package
BD7836EFV	4.5 to 5.5	1.0	5	0.1	6/10/15.6/21.6	1.9 (V _{DD} =5V, 4Ω, THD+N=1%)	0.1	16	HTSSOP-B20

Portable Amplifiers 1.1W to 1.5W Monaural Speaker Amplifiers

Part No.	Supply Voltage (V)	Power Dissipation (W)	Quiescent Current (mA)	Standby Current (μA)	Voltage Gain (dB)	Output Power (R _L =8Ω, THD=10%)		Distortion (%)	Output Noise Voltage (dBV)	Package
						V _{CC} =3.6V	V _{CC} =5.0V			
BH7824FVM	2.4 to 5.5	470	3.5	0	0 to 20	0.60W	1.1W	0.07	-94	MSOP8
BH7826FVM	2.6 to 5.5	470	3.5	0	0 to 20	0.60W	1.1W	0.2	-94	MSOP8
BD7830NUV	2.4 to 5.5	530	3.2	0	0 to 20	0.77W	1.5W	0.1	-100	VSON008V2030

Portable Amplifiers Analog Input Monaural Class-D Speaker Amplifiers

Part No.	Supply Voltage (V)	Power Dissipation (W)	Quiescent Current (mA)	Voltage Gain (dB)	Output Power (W)		Distortion (%)	Output Noise Voltage (μVrms)	ALC Circuit	Package (mm)
					(V _{DD} =5V, R _L =4Ω, THD+N=10%)	(V _{DD} =3.6V, R _L =8Ω, THD+N=10%)				
BD5460GUL	2.5 to 5.5	0.69	2.0 (V _{DD} =3.6V)	6	2.5 (V _{DD} =5V, R _L =4Ω, THD+N=10%)	0.85 (V _{DD} =3.6V, R _L =8Ω, THD+N=10%)	0.3 (V _{DD} =3.6V)	30	—	VCSP50L1 (1.6×1.6)
BD5461GUL	2.5 to 5.5	0.69	2.0 (V _{DD} =3.6V)	12	2.5 (V _{DD} =5V, R _L =4Ω, THD+N=10%)	0.85 (V _{DD} =3.6V, R _L =8Ω, THD+N=10%)	0.3 (V _{DD} =3.6V)	40	—	VCSP50L1 (1.6×1.6)
BD27400GUL	2.5 to 5.5	0.69	2.9 (V _{DD} =3.6V)	External Variable	2.5 (V _{DD} =5V, R _L =4Ω, THD+N=10%)	0.85 (V _{DD} =3.6V, R _L =8Ω, THD+N=10%)	0.3 (V _{DD} =3.6V)	40	—	VCSP50L1 (1.5×1.5)
BD5632NUX	2.5 to 5.5	0.52	2.7 (V _{DD} =3.6V)	6	2.5 (V _{DD} =5V, R _L =4Ω, THD+N=10%)	0.85 (V _{DD} =3.6V, R _L =8Ω, THD+N=10%)	0.1 (V _{DD} =3.6V)	40	—	VSON008X2030
BD5634NUX	2.5 to 5.5	0.52	2.7 (V _{DD} =3.6V)	12	2.5 (V _{DD} =5V, R _L =4Ω, THD+N=10%)	0.85 (V _{DD} =3.6V, R _L =8Ω, THD+N=10%)	0.1 (V _{DD} =3.6V)	40	—	VSON008X2030
BD5638NUX	2.5 to 5.5	0.52	2.7 (V _{DD} =3.6V)	18	2.5 (V _{DD} =5V, R _L =4Ω, THD+N=10%)	0.85 (V _{DD} =3.6V, R _L =8Ω, THD+N=10%)	0.1 (V _{DD} =3.6V)	40	—	VSON008X2030
BD5465GUL	2.5 to 5.5	0.69	3.3 (V _{DD} =3.6V)	12	0.6 (V _{DD} =3.6 to 5.5V)		0.1 (V _{DD} =3.6V)	40	✓	VCSP50L1 (1.8×1.8)
BD5466GUL	2.5 to 5.5	0.69	3.0 (V _{DD} =3.6V)	18	1.5 (V _{DD} =5V, R _L =4Ω, THD+N≤1%)	0.5 (V _{DD} =3.6V, R _L =8Ω, THD+N≤1%)	0.1 (V _{DD} =3.6V)	40	✓	VCSP50L1 (1.7×1.7)
BD5467GUL	2.5 to 5.5	0.69	3.0 (V _{DD} =3.6V)	13	1.5 (V _{DD} =5V, R _L =4Ω, THD+N≤1%)	0.5 (V _{DD} =3.6V, R _L =8Ω, THD+N≤1%)	0.1 (V _{DD} =3.6V)	40	✓	VCSP50L1 (1.7×1.7)
BD5468GUL	2.5 to 5.5	0.69	3.0 (V _{DD} =3.6V)	13	1.5 (V _{DD} =5V, R _L =4Ω, THD+N≤1%)	0.5 (V _{DD} =3.6V, R _L =8Ω, THD+N≤1%)	0.1 (V _{DD} =3.6V)	40	✓	VCSP50L1 (1.7×1.7)
BD5469GUL	2.5 to 5.5	0.69	3.0 (V _{DD} =3.6V)	13	0.88 (V _{DD} =4.2V, R _L =8Ω, THD+N≤1%)	0.64 (V _{DD} =3.6V, R _L =8Ω, THD+N≤1%)	0.1 (V _{DD} =3.6V)	40	✓	VCSP50L1 (1.7×1.7)

Portable Amplifier Analog Input Stereo Class-D Speaker Amplifier

Part No.	Supply Voltage (V)	Power Dissipation (W)	Quiescent Current (mA)	Voltage Gain (dB)	Output Power (W)		Distortion (%)	Output Noise Voltage (μVrms)	Max. LDO Current (mA)	Package
BD28412MUV	4.5 to 13	3.26	16 (V _{CC} =11V)	20/26/ 32/36	18 (V _{CC} =12V, R _L =4Ω, THD+N=10%, PBTl)	9 (V _{CC} =12V, R _L =8Ω, THD+N=10%)	0.03 (V _{CC} =11V)	100	—	VQFN032V5050

Mid/High-Power Amplifiers Class-D Speaker Amplifiers for Digital Input with Built-in DSP

Part No.	Supply Voltage (V)	Power Dissipation (W)	Quiescent Current (mA)	Output Power (W)		Distortion (%)	Output Noise Voltage (μVrms)	DSP					Package
				(V _{CC} =13V, R _L =8Ω)	(V _{CC} =18V, R _L =8Ω)			Volume	DC Cut HPF	Hard Clipper	Parametric EQ	DRC	
New BM28723MUV	10 to 24	4.56 (4-layer board)	45 (V _{CC} =18V)	10 (V _{CC} =13V, R _L =8Ω)	17 (V _{CC} =18V, R _L =8Ω)	0.08	150	✓	✓	✓	✓ (12 Band)	✓ (3 Band)	VQFN032V5050
BM28720MUV	10 to 24	4.56 (4-layer board)	45 (V _{CC} =18V)	10 (V _{CC} =13V, R _L =8Ω)	20 (V _{CC} =18V, R _L =8Ω)	0.07	80	✓	✓	✓	✓ (12 Band)	✓ (3 Band)	VQFN032V5050

Mid/High-Power Amplifier Class-D Speaker Amplifier for Digital Input									
Part No.	Supply Voltage (V)	Power Dissipation (W)	Quiescent Current (mA)	Output Power (W)		Distortion (%)	Output Noise Voltage (μ Vrms)	Power Limiter Function	Package
BD28623MUV	8.5 to 24	4.56 (4-layer board) 3.26 (2-layer board)	40 (Vcc=18V)	—	15 (Vcc=16V RL=8 Ω)	0.08	150	✓ (GAIN)	VQFN024V4040

Mid/High-Power Amplifiers Analog Input/BTL Output Class-D Speaker Amplifiers										
Part No.	Supply Voltage (V)	Power Dissipation (W)	Quiescent Current (mA)	Voltage Gain (dB)	Output Power (W)		Distortion (%)	Output Noise Voltage (μ Vrms)	Power Limiter Function	Package
BD5424EFS	10 to 18	4.5 (4-layer board) 2.0 (2-layer board)	30 (Vcc=12V)	28	10 (Vcc=12V RL=8 Ω)	20 (Vcc=17V RL=8 Ω)	0.1	80	✓ (Power Limiter)	HTSSOP-A44
BD5423AEFS	10 to 16.5	4.5 (4-layer board) 2.0 (2-layer board)	25 (Vcc=12V)	28	10 (Vcc=12V RL=8 Ω)	17 (Vcc=12V RL=4 Ω)	0.1	80	✓ (Power Limiter)	HTSSOP-A44
BD5426EFS	10 to 16.5	4.5 (4-layer board) 2.0 (2-layer board)	25 (Vcc=12V)	28	9 (Vcc=12V RL=8 Ω)	10 (Vcc=13V RL=8 Ω)	0.1	80	✓ (Power Limiter)	HTSSOP-A44
BD5413EFV	6 to 10.5	2.8 (4-layer board) 1.1 (2-layer board)	12 (Vcc=9V)	30	4 (Vcc=9V RL=8 Ω)	5 (Vcc=9V RL=6 Ω)	0.2	90	—	HTSSOP-B24

Mid/High-Power Amplifier 5W+5W Stereo Speaker Amplifier										
Part No.	Supply Voltage (V)	Power Dissipation (W)	Quiescent Current (mA)	Standby Current (μ A)	Output Power(W) [Vcc=12V, RL=3 Ω]	Closed Loop Voltage Gain (dB)	Output Noise Voltage (mVrms)	Distortion (%)	Ripple Rejection (dB)	Package
BA5417	6 to 15	15	22	0	5	45	0.3	0.1	55	H5IP15

Headphone Amplifiers

Ultra-Compact Coupling Capacitorless Headphone Amplifiers									
Part No.	Supply Voltage (V)	Quiescent Current (mA)	Gain (V/V)	Maximum Output Power (mW)	Distortion (%)	Output Noise Voltage (μ Vrms)	Ripple Rejection (dB)	Note	Package (mm)
BD88200GUL	2.4 to 5.5	2	Variable Gain with external resistor	80 (VDD=3.3V, RL=16 Ω)	0.006 (VDD=3.3V, RL=16 Ω)	10	-80 (f=217Hz)	Virtual ground based	VCSP50L2 (2.1 \times 2.1)
BD88210GUL	2.4 to 5.5	2	-1.0	80 (VDD=3.3V, RL=16 Ω)	0.006 (VDD=3.3V, RL=16 Ω)	10	-80 (f=217Hz)	Virtual ground based	VCSP50L2 (2.1 \times 2.1)
BD88215GUL	2.4 to 5.5	2	-1.5	80 (VDD=3.3V, RL=16 Ω)	0.006 (VDD=3.3V, RL=16 Ω)	10	-80 (f=217Hz)	Virtual ground based	VCSP50L2 (2.1 \times 2.1)
BD88220GUL	2.4 to 5.5	2	-1.0	80 (VDD=3.3V, RL=16 Ω)	0.006 (VDD=3.3V, RL=16 Ω)	10	-80 (f=217Hz)	Virtual ground based	VCSP50L2 (2.1 \times 2.1)
BD88400GUL	2.4 to 5.5	2	Variable Gain with external resistor	80 (VDD=3.3V, RL=16 Ω)	0.006 (VDD=3.3V, RL=16 Ω)	10	-80 (f=217Hz)	Ground based	VCSP50L2 (2.1 \times 2.1)
BD88400FJ	2.4 to 5.5	2	Variable Gain with external resistor	80 (VDD=3.3V, RL=16 Ω)	0.006 (VDD=3.3V, RL=16 Ω)	10	-80 (f=217Hz)	Ground based	SOP-J14
BD88410GUL	2.4 to 5.5	2	-1.0	80 (VDD=3.3V, RL=16 Ω)	0.006 (VDD=3.3V, RL=16 Ω)	10	-80 (f=217Hz)	Ground based	VCSP50L2 (2.1 \times 2.1)
BD88415GUL	2.4 to 5.5	2	-1.5	80 (VDD=3.3V, RL=16 Ω)	0.006 (VDD=3.3V, RL=16 Ω)	10	-80 (f=217Hz)	Ground based	VCSP50L2 (2.1 \times 2.1)
BD88420GUL	2.4 to 5.5	2	-2.0	80 (VDD=3.3V, RL=16 Ω)	0.006 (VDD=3.3V, RL=16 Ω)	10	-80 (f=217Hz)	Ground based	VCSP50L2 (2.1 \times 2.1)

Headphone Amplifier Designed for 0.93V Low Voltage Operation									
Part No.	Supply Voltage (V)	Quiescent Current (mA)	Maximum Output Power (mW)		Distortion (%)		Output Noise Voltage (μ Vrms)	Package	
			Single-ended(16 Ω)	BTL(8 Ω)	Single-ended(16 Ω)	BTL(8 Ω)			
BU7150NUV	0.93 to 3.5 (Ta=0°C or more)	1.0	14 (VDD=1.5V)	85 (VDD=1.5V)	0.1(Po=5mW)	0.2(Po=25mW)	10	VSON010V3030	

Standard Headphone Amplifiers							
Part No.	Supply Voltage (V)	Quiescent Current (mA)	Voltage Gain (dB)	Maximum Output Power(mW) RL=16 Ω	Distortion (%)	Ripple Rejection (dB)	Package
BH3544F	2.8 to 6.5	7.0	6	62	0.02	57	SOP8
BH3547F	4.5 to 6.5	3.7	6	77	0.05	57	SOP8
BH3548F	4.0 to 5.5	6.5	6	62 (120@RL=8 Ω)	0.02	57	SOP8

Others

Audio Subsystems															
Part No.	Supply Voltage (V)	Power Dissipation (mW)	Quiescent Current (mA)	Standby Current (μA)	SP Amp.			HP Amp.			Package				
					Voltage Gain (dB)	Distortion (%)	Output Power(W) V _{CC} =5V	Voltage Gain (dB)	Distortion (%)	HP AMP/Maximum Output Voltage (dBV) V _{CC} =3.3V					
BH7881EFV	3.3 to 5.5	1100	18	0	11(SE)/17(BTL)	0.04	2	5.5	0.02	1.4	HTSSOP-B24				
BH7884EFV	3.0 to 5.5	1100	9	0.2	12(SE)/18.2(BTL)	0.1	1	5.6	0.03	1.0	HTSSOP-B24				
Line Amplifier (OP Amplifier)															
Part No.	Supply Voltage (V)	Circuit Current (mA)	Open Loop Gain (dB)	Input	CMRR (dB)	Supply Voltage Rejection Ratio (dB)	Common-mode Input Voltage Range(V) V _{CC} =8V	Offset Voltage (mV)	Offset Current (nA)	Input Bias Current (nA)	Distortion (%)	Channel Separation (dB)	Gain Bandwidth Product (MHz)	Slew Rate (V/μs)	Package
BA3131FS	6.0 to 16.0	4.9	110	3	72	90	6	0.5	5	50	0.003	115	2.6	1.2	SSOP-A20
Line Amplifiers (Output Coupling Capacitor-less Line Amplifier)															
Part No.	Supply Voltage (V)	Circuit Current (mA)	Channel	Voltage Gain (dB)	Maximum Output Voltage (Vrms)	Distortion (%)	Output Noise Voltage (μVrms)	Channel Separation (dB)	Ripple Rejection (dB)	Charge Pump	Package				
BD8876FV	3.0 to 5.5	3.2	2	6 or 9	3.5	0.0025	8	80	65	✓	SSOP-B14				
BD8878FV	3.0 to 5.5	3.2	2	6.7	3	0.0025	10	65	65	✓	SSOP-B14				
Line Amplifiers (Preamps with Built-in ALC)															
Part No.	Supply Voltage (V)	Circuit Current (mA)	Open Loop Gain (dB)	Distortion (%)	Input Resistance (Ω)	Maximum Output Voltage (Vrms)	Equivalent Input Noise Voltage (μVrms)	ALC Range (dB)	Channel Balance (dB)	Channel Separation (dB)	Package				
BA3308F	4.5 to 14.0	3.5	80	0.1	25	1.2	1.0	45	0	75	SOP14				
BA3308FV	4.5 to 14.0	3.5	80	0.1	25	1.2	1.0	45	0	75	SSOP-B14				
Isolation Amplifiers															
Part No.	Supply Voltage (V)	Operating Temperature (°C)	Circuit	Circuit Current (mA)	Voltage Gain (dB)	CMRR (dB)	Common-mode Input Voltage Range(V) V _{CC} =8V	THD (%)	Output Noise Voltage (μVrms)	Channel Separation (dB)	Slew Rate (V/μs)	Input Resistance (kΩ)	Package		
BA3121F	4.0 to 18.0	-30 to +85	2	9.0	-0.04	57	3.75	0.002	3.5	82	2.0	55	SOP8		
BA3123F	4.0 to 18.0	-40 to +85	2	9.0	-0.04	57	3.75	0.002	3.5	82	2.0	55	SOP8		

Audio Processors

Analog Audio Processors

6ch/8ch Sound Processors with Built-in Micro-step Volume												
Part No.	Supply Voltage (V)	Circuit Current (mA)	Output Noise Voltage (μVrms)	Distortion (%)	Selector	Main Volume		Zone Volume		Tone Control	Serial Control	Package
						Channel (ch)	Step	Channel (ch)	Step			
BD34704KS2	±6.5 to ±7.5	±32	1.2	0.0004	18	+32 to -95dB 0.5dB/Step	8	+7.5 to -91.5dB 0.5dB/Step	2	—	2 Wire	SQFP-T80C
BD34705KS2	±6.5 to ±7.5	±32	1.2	0.0004	12	+32 to -95dB 0.5dB/Step	8	+6 to -16dB 1dB/Step -16 to -56dB 2dB/Step	2	—	2 Wire	SQFP-T64
BD34701KS2	±6.5 to ±7.5	±22	1.5	0.0004	8	+32 to -95dB 0.5dB/Step	8	—	—	—	2 Wire	SQFP-T52
BD3471KS2	±6.5 to ±7.5	±30	1.5	0.0004	12	+24 to -95dB 0.5dB/Step	8	—	—	—	2 Wire	SQFP-T80C
BD3473KS2	±6.5 to ±7.5	±30	1.5	0.0004	12	+24 to -95dB 0.5dB/Step	8	—	—	Bass, Treble	2 Wire	SQFP-T80C
BD3474KS2	±6.5 to ±7.5	±30	1.5	0.0004	12	+32 to -95dB 0.5dB/Step	8	—	—	Bass, Treble	2 Wire	SQFP-T80C
2ch/4ch/6ch Sound Processors												
BD34700FV	±6.5 to ±7.5	±22	1.5	0.0004	—	+32 to -95dB 0.5dB/Step	4	—	—	—	2 Wire	SSOP-B40
☆ BD34710FV	±6.5 to ±7.5	±22	1.5	0.0004	3	+32 to -95dB 0.5dB/Step	6	—	—	—	2 Wire	SSOP-B40
BD3812F	±5.0 to ±7.3	±2	1.2	0.0050	—	0.6 to 18dB 2dB/Step 0 to -103dB 1dB/Step	2	—	—	—	2 Wire	SOP14
BD3814FV	±5.0 to ±7.3	±7	1.0	0.001	—	0 to -95dB 1dB/Step	6	—	—	Bass, Treble	2 Wire	SSOP-B40

☆ : Under Development

6ch Sound Processors																
Part No.	Supply Voltage (V)	Circuit Current (mA)	Output Noise Voltage (μ Vrms)	Distortion (%)	Selector	Input Gain	Output Gain	Volume	Number of Volume	Tone Control	Bass Boost	Serial Control	Package			
BD3811K1	± 5.0 to ± 7.3	± 15	2.0	0.005	8	0,6dB	0,6 to 18dB 2dB/Step	0 to -103dB 1dB/Step	6	Bass, Treble	✓	2 Wire	QFP80			
BD3818KS	± 5.0 to ± 7.4	± 28	1.0	0.002	5	0,3,6,9dB	—	0 to -95dB 1dB/Step	6	Bass, Treble	(Dynamic)	2 Wire	SQFP80			
7ch Sound Processors																
Part No.	Supply Voltage (V)	Current Consumption (mA)	Output Noise Voltage (μ Vrms)	Distortion (%)	Selector	Input Gain	Output Gain	Volume	Number of Volume	Tone Control	Serial Control	Package				
BD3816K1	± 5.0 to ± 7.3	± 24	1.2	0.001	7	0 to 7dB 1dB/Step	0 to 17dB 1dB/Step	0 to -95dB 1dB/Step	7	Bass, Treble	2 Wire	QFP80				
BD3817KS	± 5.0 to ± 7.3	± 24	1.2	0.001	10	0 to 7dB 1dB/Step	0 to 17dB 1dB/Step	0 to -95dB 1dB/Step	7	Bass, Treble	2 Wire	SQFP100				
6ch/9ch Stereo Input Selector ICs Maximum Input Voltage : 4.2V																
Part No.	Supply Voltage (V)	Current Consumption (mA)	Output Noise Voltage (μ Vrms)	Distortion (%)	Selector	Serial Control	Package									
BD3843FS	± 4.0 to ± 7.3	± 3	1.0	0.004	6	2 Wire	SSOP-A24									
BD3841FS	± 5.0 to ± 7.3	± 3	1.0	0.004	9	2 Wire	SSOP-A32									
Sound Processors with Built-in 2-band Equalizer																
Part No.	Supply Voltage (V)	Current Consumption (mA)	Selector		Input Gain (dB)	Volume (dB)	Fader		Parametric EQ	Loudness	LPF for Sub Woofer	Option	Serial Control	Output Noise Voltage (μ Vrms)	Distortion (%)	Package
			Single	Diff.			(dB)	Output								
BD37503FV	7 to 9.5	20	3	1	0 to +20	0 to -36, -∞	0 to -63, -∞	4	—	✓*	—	Anti-aliasing Filter*	I ² C BUS	5.8	0.001	SSOP-B20
BD37511FS	7 to 9.5	15	3	0	0 to +20	0 to -40	0 to -62, -∞	4	—	—	—	—	I ² C BUS	6	0.005	SSOP-A20
BD37512FS	7 to 9.5	15	3	1	0 to +20	0 to -40	0 to -62, -∞	4	—	—	—	—	I ² C BUS	6	0.005	SSOP-A20
BD37513FS	7 to 9.5	38	3	1	0 to +20	+15 to -79, -∞	0 to -79, -∞	4	—	✓	—	—	I ² C BUS	3.8	0.001	SSOP-A20
BD37514FS	7 to 9.5	38	3	1	0 to +20	+15 to -79, -∞	0 to -79, -∞	5	✓	✓	—	—	I ² C BUS	3.8	0.001	SSOP-A20
BD37515FS	7 to 9.5	38	3	1	0 to +20	+15 to -79, -∞	+15 to -79, -∞	5	✓	✓	✓	—	I ² C BUS	3.8	0.001	SSOP-A20
BD37521FS	7 to 9.5	38	3	1	0 to +20	+15 to -79, -∞	0 to -79, -∞	4	—	EXT	—	—	I ² C BUS	3.8	0.001	SSOP-A24
BD37522FS	7 to 9.5	38	4	1	0 to +20	+15 to -79, -∞	0 to -79, -∞	4	✓	✓	—	—	I ² C BUS	3.8	0.001	SSOP-A24
BD37523FS	7 to 9.5	38	4	1	0 to +20	+15 to -79, -∞	+15 to -79, -∞	5	✓	✓	✓	—	I ² C BUS	3.8	0.001	SSOP-A24
BD3870FS	4.5 to 9.5	8	3	—	0/6/12/18	0 to -87, -∞	—	2	EXT	—	—	Surround	2 Wire	4.5	0.01	SSOP-A24
BD3871FS	4.5 to 9.5	8	3	—	24/26/28	0 to -87, -∞	—	2	EXT	—	—	Surround	2 Wire	40 (Gv=24dB)	0.01	SSOP-A24
BD3872FS	4.5 to 9.5	8	5	—	0/5/10/19/ 23/26/28	0 to -87, -∞	—	2	EXT	—	—	Surround	2 Wire	4.5	0.01	SSOP-A32
BD3873FS	4.5 to 9.5	8	3	—	18/21/24/27	0 to -87, -∞	—	2	EXT	—	—	Surround	2 Wire	40 (Gv=24dB)	0.01	SSOP-A24
BD3490FV	4.75 to 9.5	7	4	—	0/2/4/6/ 8/12/16/20	0 to -87 (2ch Independent control), -∞	—	2	EXT	—	—	Bass Boost, Surround	I ² C BUS	5	0.002	SSOP-B28
BD3491FS	4.75 to 9.5	7	6	—	0/2/4/6/ 8/12/16/20	0 to -87 (2ch Independent control), -∞	—	2	EXT	—	—	Bass Boost, Surround	I ² C BUS	5	0.002	SSOP-A32

Sound Processors with Built-in 2-band Equalizer : Built-in Bass and Treble control *Loudness and Anti-aliasing Filter can be used exclusively. EXT : Set by external components

Analog Audio Processors

Sound Processors with Built-in 3-band Equalizer																			
Part No.	Supply Voltage (V)	Current Consumption (mA)	Selector		Input Gain (dB)	Volume (dB)	Fader		Parametric EQ	Loudness	LPF/HPF for Sub Woofer	Mixing		Level Meter	Option	Serial Control	Output Noise Voltage (μVrms)	Distortion (%)	Package
			Single	Diff.			(dB)	Outputs				ATT	ATT						
BD37524FS	7.0 to 9.5	38	4	1	0 to +20	+15 to -79, -∞	+15 to -79, -∞	6	✓	✓	LPF	—	—	✓	—	I ² C BUS	3.8	0.001	SSOP-A24
BD37531FV	7.0 to 9.5	38	2/3/5	3/2/1	0 to +20	+15 to -79, -∞	+15 to -79, -∞	6	✓	✓	—	—	—	—	—	I ² C BUS	3.8	0.001	SSOP-B28
BD37532FV	7.0 to 9.5	38	2/3/5	3/2/1	0 to +20	+15 to -79, -∞	+15 to -79, -∞	6	✓	✓	LPF	—	—	—	—	I ² C BUS	3.8	0.001	SSOP-B28
BD37533FV	7.0 to 9.5	38	2/3/5	3/2/1	0 to +20	+15 to -79, -∞	+15 to -79, -∞	6	✓	✓	LPF	✓	✓	—	—	I ² C BUS	3.8	0.001	SSOP-B28
BD37534FV	7.0 to 9.5	38	2/3/5	3/2/1	0 to +20	+15 to -79, -∞	+15 to -79, -∞	6	✓	✓	LPF	✓	✓	✓	—	I ² C BUS	3.8	0.001	SSOP-B28
BD37541FS	7.0 to 9.5	38	2/3/5	3/2/1	0 to +20	+15 to -79, -∞	0 to -79, -∞	6	✓	EXT	—	✓	—	—	—	I ² C BUS	3.8	0.001	SSOP-B28
BD37542FS	7.0 to 9.5	38	2/3/5	3/2/1	0 to +20	+15 to -79, -∞	+15 to -79, -∞	6	✓	EXT	LPF	✓	✓	—	—	I ² C BUS	3.8	0.001	SSOP-A32
BD37543FS	7.0 to 9.5	38	2/3/5	3/2/1	0 to +20	+15 to -79, -∞	+15 to -79, -∞	6	✓	EXT	LPF + HPF	✓	✓	✓	—	I ² C BUS	3.8	0.001	SSOP-A32
BD37544FS	7.0 to 9.5	38	1/3/4	3/2/1	0 to +20	+15 to -79, -∞	+15 to -79, -∞	6	✓	—	LPF + HPF	✓	✓	—	Super Bass	I ² C BUS	3.8	0.001	SSOP-A32
BD37545FS	7.0 to 9.5	38	2/3/5	3/2/1	0 to +20	+15 to -79, -∞	+15 to -79, -∞	6	✓	—	LPF + HPF	✓	✓	✓	External I/O	I ² C BUS	3.8	0.001	SSOP-A32
BD37033FV-M	7.0 to 9.5	31	3/5	2/1	0 to +16	+15 to -79, -∞	+15 to -79, -∞	6	✓	✓	LPF	✓	✓	✓	—	I ² C BUS	5.5	0.002	SSOP-B28
BD37034FV-M	7.0 to 9.5 VccL to 13	36	3/5	2/1	0 to +16	+15 to -79, -∞	+15 to -79, -∞	6	✓	✓	LPF + HPF	✓	✓	✓	High Voltage Output	I ² C BUS	6	0.002	SSOP-B28
BD3883FS	6.5 to 9.5	8	5	—	0/6/12/16/20/23/26/29	0 to -87, -∞	0/-10	2	EXT	—	—	—	—	—	Surround	2 Wire	4	0.01	SSOP-A32
BD3403FV	6.5 to 9.5	16	5	—	0 to +26 (2dB/Step)	0 to -30 (2dB/Step)	0 to -59, -∞	2	EXT	—	—	—	—	—	Surround	2 Wire	8	0.02	SSOP-B40

General-Purpose Electronic Volume with Built-in Advanced Switch																		
Part No.	Supply Voltage (V)	Current Consumption (mA)	Selector		Input Gain (dB)	Fader Volume (dB)	Outputs	Mixing		Post Filter	High-Voltage Output (dB)	Serial Control	Output Noise Voltage (μVrms)	Distortion (%)	Package			
			Single	Diff.				Channel (ch)	ATT (dB)									
BD3464FV	7.0 to 9.5	25	—	—	—	+23 to -79, -∞ (1dB/Step)	4	—	—	—	—	I ² C BUS	1.9	0.0004	SSOP-B20			
BD3465FV	7.0 to 9.5	25	—	—	—	+23 to -79, -∞ (1dB/Step)	4	3	+0 to -64, -∞ (8dB/Step)	—	—	I ² C BUS	1.9	0.0004	SSOP-B20			
BD3460FS	7.0 to 9.5	25	—	—	—	+23 to -79, -∞ (1dB/Step)	6	—	—	—	—	I ² C BUS	1.9	0.0004	SSOP-A24			
BD3461FS	7.0 to 9.5	25	—	—	—	+23 to -79, -∞ (1dB/Step)	6	3	+0 to -64, -∞ (8dB/Step)	—	—	I ² C BUS	1.9	0.0004	SSOP-A24			
BD34602FS-M	7.0 to 9.5	35	—	—	—	+23 to -79, -∞ (1dB/Step)	6	3	+0 to -79, -∞ (1dB/Step)	—	—	I ² C BUS	1.3	0.0004	SSOP-A24			
BD37067FV-M	7.0 to 9.5	37	2/3/4/5	4/3/2/1	+23 to -15 (1dB/Step)	+23 to -79, -∞ (1dB/Step)	6	1	—	✓	—	I ² C BUS	8	0.003	SSOP-B40			
BD37068FV-M	7.0 to 9.5 VccL to 17.8	30/7	1/2/3/4/5	5/4/3/2/1	+23 to -15 (1dB/Step)	+23 to -79, -∞ (1dB/Step)	6	1	—	✓	0/8.3	I ² C BUS (High-Voltage Mode)	23	0.003	SSOP-B40			
BD37069FV-M	7.0 to 9.5 VccL to 17.8	30/7	2/3/4/5	4/3/2/1	+23 to -15 (1dB/Step)	+23 to -79, -∞ (1dB/Step)	6	1	—	✓	2/4.6/8.3	I ² C BUS (High-Voltage Mode)	23	0.003	SSOP-B40			

6ch Electronic Volume for 5.1ch Car Theater System																		
Part No.	Supply Voltage (V)	Current Consumption (mA)	Input Selector		Input Gain (dB)	5.1ch Volume (dB)	Monaural Volume (dB)	Output Gain (dB)	Mix Car Nav. Cell Phones	Output for Spectrum Analyzer	Serial Control	Output Noise Voltage (μVrms)	Distortion (%)	Package				
			Single Input	Monaural Differential Input														
BD3433K	±7.0 to ±9.5	12	5.1ch × 2	1	0,6,12 (Each F,R)	+23 to -79, -∞ (1dB/step)	+15 to -63, -∞ (1dB/step)	0, +2.5(A) 0, -4.5(B)	✓	✓	3 Wire	3	0.001	QFP44				

Sound Processors with Built-in 3-band Equalize : EXT : Set by external components

Single Power Supply Sound Processors with Built-in Pre Amplifier for Tape Recording and Playback																		
Part No.	Supply Voltage (V)	Current Consumption (mA)	Selector	Input Gain (dB)	Volume (dB)	Tone Control	Dynamic Bass	Surround	REC/PB Amp.	Vocal Cut	Output for Spectrum Analyzer	Serial Control	Output Noise Voltage (μVrms)	Max. Output (Vrms)	Distortion (%)	Package		
																	BD3401KS2	8.0 to 9.5
BD3402KS2	8.0 to 9.5	28	5	-5/0/3.5	0 to -76/-∞ (2/4/Step)	Bass, Treble	—	—	✓	—	—	2 Wire	2.5	2.5	0.005	SQFP-T64		

Bandpass Filter ICs for Spectrum Analyzer Display										
Part No.	Supply Voltage (V)	Current Consumption (mA)	Band	Input Mix Amplifier	REC Level Display	Standard Output (V)	Maximum Output (V)	BPF Center Frequency (Hz)		Package
BA3835F	4.5 to 6.5	8.5	5	✓	—	1.35	4.8	105,340,1k, 3.4k,10.5k		SOP18
BA3834F	4.5 to 6.5	10.0	7	✓	—	1.35	4.8	68,170,420,1k, 2.4k,5.9k,14.4k		SOP18

Sound Processors with Built-in 3-band Equalizer : BD37531FV, BD37532FV, BD37533FV and BD37534FV are pin-compatible.

BD37541FS, BD37542FS and BD37543FS are pin-compatible. BD37033FV-M and BD37034FV-M are pin-compatible.

General-Purpose Electronic Volume with Built-in Advanced Switch : BD3460FS, BD3461FS and BD34602FS-M are pin-compatible. BD3464FS and BD3465FS are pin-compatible. BD37067FV-M and BD37068FV-M are pin-compatible.

AUDIO SoCs

Audio 1Chip System ICs													
Part No.	Supply Voltage (V)	USB I/F	SD I/F	CD DSP	SDRAM	Quad SPI I/F	SPI I/F	I ² C I/F	UART I/F	Digital Audio I/F	GPIO (Dedicated pins)	Operating Temperature (C)	Package
New BM94715EKU	HVcc 3.0 to 3.6 LVcc 1.45 to 1.65	USB2.0 Dual Role Full Speed (Host/Device) (1ch)	SDIO	3Beam Method	16Mbit Stack	1ch	Master 1ch Slave 1ch	Master Slave 2ch	HS UART 2ch	I ² S IN 2ch 2 series, I ² S OUT 2ch 1 series	77 (16)	-40 to +85	HTQFP128UA
New BM94803AEKU	HVcc 3.0 to 3.6 LVcc 1.45 to 1.65	USB2.0 Dual Role High Speed (Host/Device) (1ch)	SDIO	3Beam Method	16Mbit Stack	1ch	Master 1ch Slave 1ch	Master Slave 2ch	HS UART 2ch	I ² S IN 2ch 2 series, I ² S OUT 2ch 1 series	77 (13)	-40 to +85	HTQFP128UA

Media Decoders

AAC/WMA/MP3/WAV + SD Memory Card + CD-ROM																
Part No.	Supply Voltage (V)	USB	SD	iPod	Serial I/F	Display Information	MP3	WMA	AAC	CD-ROM Mode	CD-ROM File System	MP3 Recording Format	File Search	Audio Output		Package
														Analog	Digital	
BU94605AKV	3.0 to 3.6	USB2.0 Full Speed	MMC SD miniSD microSD SDHC	—	I ² C BUS	Folder number, File number, Play time, Folder name, File name, TAG(Artist, Album, Title)	MPEG1,2,2.5 LAYER1,2,3	WMA9 Standard	MPEG4 AAC-LC	Mode1, Mode2, form1/2, Romeo, Joliet	ISO9660 Level1,2	—	Search during the playback	Line	I ² S S/PDIF	VQFP80
BU94607AKV	3.0 to 3.6	USB2.0 Full Speed	MMC SD miniSD microSD SDHC	iPod touch- iPhone- iPad	I ² C BUS	Folder number, File number, Play time, Folder name, File name, TAG(Artist, Album, Title)	MPEG1,2,2.5 LAYER1,2,3	WMA9 Standard	MPEG4 AAC-LC	Mode1, Mode2, form1/2, Romeo, Joliet	ISO9660 Level1,2	—	Search during the playback	Line	I ² S S/PDIF	VQFP80
BU94702AKV	3.0 to 3.6	USB2.0 Full Speed	MMC SD miniSD microSD SDHC	—	I ² C BUS	Folder number, File number, Play time, Folder name, File name, TAG(Artist, Album, Title)	MPEG1,2,2.5 LAYER1,2,3	WMA9 Standard	MPEG4 AAC-LC	Mode1, Mode2, form1/2, Romeo, Joliet	ISO9660 Level1,2	MPEG1 Layer3 Sample Rate : 32,44,1,48kHz Bit Rate : 32,64,128, 192,256,320kHz	Search during the playback	Line	I ² S S/PDIF	VQFP80
BU94705AKV	3.0 to 3.6	USB2.0 Full Speed	MMC SD miniSD microSD SDHC	iPod touch- iPhone- iPad	I ² C BUS	Folder number, File number, Play time, Folder name, File name, TAG(Artist, Album, Title)	MPEG1,2,2.5 LAYER1,2,3	WMA9 Standard	MPEG4 AAC-LC	Mode1, Mode2, form1/2, Romeo, Joliet	ISO9660 Level1,2	MPEG1 Layer3 Sample Rate : 32,44,1,48kHz Bit Rate : 32,64,128, 192,256,320kHz	Search during the playback	Line	I ² S S/PDIF	VQFP80

Media Decoders : iPod, iPad and iPhone are registered trademarks of Apple Inc. in the U.S. and other countries.

Video Amplifiers

Composite Video Amplifiers

Ultra-compact(WL-CSP) Output Capacitor-less 1ch Video Drivers												
Part No.	Supply Voltage (V)	Circuit Current (mA)	Amplifier Gain (dB)	Freq. Chara.1 (dB)	Freq. Chara.2 (dB)	Input Type	LPF	Mute (Standby) (μA)	Output Capa-less	Max. Output Level (V _{P-P})	Video Out -> In Change Mode	Package (mm)
BH76906GU	2.5 to 3.45	15	6	-0.2 (4.5MHz)	-26 (18MHz)	Bias (150kΩ)	8th order 4.5MHz	0	✓	5.2	—	VCSP85H1 (1.6×1.6),H=1.0 Max.
BH76909GU	2.5 to 3.45	15	9	-0.2 (4.5MHz)	-26 (18MHz)	Bias (150kΩ)	8th order 4.5MHz	0	✓	5.2	—	VCSP85H1 (1.6×1.6),H=1.0 Max.
BH76912GU	2.5 to 3.45	15	12	-0.2 (4.5MHz)	-26 (18MHz)	Bias (150kΩ)	8th order 4.5MHz	0	✓	5.2	—	VCSP85H1 (1.6×1.6),H=1.0 Max.
BH76916GU	2.5 to 3.45	15	16.5	-0.2 (4.5MHz)	-26 (18MHz)	Bias (150kΩ)	8th order 4.5MHz	0	✓	5.2	—	VCSP85H1 (1.6×1.6),H=1.0 Max.
BH76706GU	2.5 to 3.45	15	6	-0.2 (4.5MHz)	-28 (18MHz)	Bias (150kΩ)	8th order 4.5MHz	0	✓	5.2	✓	VCSP85H1 (1.6×1.6),H=1.0 Max.

Output Capacitor-less 1ch Video Drivers											
Part No.	Supply Voltage (V)	Circuit Current (mA)	Amplifier Gain (dB)	Freq. Chara.1 (dB)	Freq. Chara.2 (dB)	Input Type	LPF	Mute (Standby) (μA)	Output Capa-less	Max. Output Level (V _{P-P})	Package
BH76806FVM	2.5 to 3.45	16	6	-0.45 (4.5MHz)	-51 (23.5MHz)	Bias (150kΩ)	8th order 4.5MHz	0	✓	5.2	MSOP8
BH76809FVM	2.5 to 3.45	16	9	-0.45 (4.5MHz)	-51 (23.5MHz)	Bias (150kΩ)	8th order 4.5MHz	0	✓	5.2	MSOP8
BH76812FVM	2.5 to 3.45	15	12	-0.45 (4.5MHz)	-51 (23.5MHz)	Bias (150kΩ)	8th order 4.5MHz	0	✓	5.2	MSOP8
BH76816FVM	2.5 to 3.45	15	16.5	-0.45 (4.5MHz)	-51 (23.5MHz)	Bias (150kΩ)	8th order 4.5MHz	0	✓	5.2	MSOP8

Compact Low Current 1ch Video Drivers											
Part No.	Supply Voltage (V)	Circuit Current (mA)	Amplifier Gain (dB)	Freq. Chara.1 (dB)	Freq. Chara.2 (dB)	Input Type	LPF	Mute (Standby) (μA)	Output Capa-less	Max. Output Level (V _{P-P})	Package
BH76106HFV	2.6 to 5.5	7	6	0.1 (4.5MHz)	-45 (19MHz)	Clamp	8th order 4.5MHz	0	✓	2.6	HVSOF6
BH76109HFV	2.6 to 5.5	7	9	0.1 (4.5MHz)	-45 (19MHz)	Clamp	8th order 4.5MHz	0	✓	2.6	HVSOF6
BH76112HFV	2.6 to 5.5	7	12	0.1 (4.5MHz)	-45 (19MHz)	Clamp	8th order 4.5MHz	0	✓	2.6	HVSOF6
BH76206HFV	2.6 to 5.5	8	6	-0.3 (6MHz)	-40 (27MHz)	Clamp	8th order 6MHz	0	✓	2.6	HVSOF6

1ch Video Drivers Built-in Video Switch												
Part No.	Supply Voltage (V)	Circuit Current (mA)	Amplifier Gain (dB)	Freq. Chara. (dB)	Switchers	Input Type	Video Driver	Mute	Output Capa-less	Max. Output Level(V _{P-P})		Package
										V _{CC} =3V	V _{CC} =5V	
BH76330FVM	2.8 to 5.5	10	6	0 (10MHz)	3 input 1 output	Clamp	✓	✓ (Standby)	✓	2.7	4.6	MSOP8
BH76331FVM	2.8 to 5.5	10	6	0 (10MHz)	3 input 1 output	Bias	✓	✓ (Standby)	—	2.8	4.6	MSOP8
BH76360FV	2.8 to 5.5	12	6	0 (10MHz)	6 input 1 output	Clamp	✓	✓ (Standby)	✓	2.7	4.6	SSOP-B16
BH76361FV	2.8 to 5.5	12	6	0 (10MHz)	6 input 1 output	Bias	✓	✓ (Standby)	—	2.8	4.6	SSOP-B16

Video Switches

1ch Video Switch(Wide Band-width)												
Part No.	Supply Voltage (V)	Circuit Current (mA)	Amplifier Gain (dB)	Freq. Chara. (dB)	Switchers	Input Type	Video Driver	Mute	Crosstalk (dB)	Max. Output Level(V _{P-P})		Package
										V _{CC} =3V	V _{CC} =5V	
BH76332FVM	2.8 to 5.5	9	0	0 (30MHz)	3 input 1 output	Clamp	—	✓ (Standby)	-65 (4.43MHz)	1.8	3.8	MSOP8
BH76333FVM	2.8 to 5.5	8	0	0 (30MHz)	3 input 1 output	Bias	—	✓ (Standby)	-65 (4.43MHz)	1.9	3.4	MSOP8
BH76362FV	2.8 to 5.5	11	0	0 (30MHz)	6 input 1 output	Clamp	—	✓ (Standby)	-65 (4.43MHz)	1.8	3.8	SSOP-B16
BH76363FV	2.8 to 5.5	11	0	0 (30MHz)	6 input 1 output	Bias	—	✓ (Standby)	-65 (4.43MHz)	1.9	3.4	SSOP-B16

Video and Audio Signal Switches											
Part No.	Supply Voltage (V)	Video Circuit Current (mA)	Audio Circuit Current (mA)	Video Freq. Chara 1 (dB)	Video Freq. Chara 2 (dB)	Video Amp. Gain (dB)	Audio Freq. Chara 1 (dB)	Audio Freq. Chara 2 (dB)	Audio Amp. Gain (dB)	Residual Noise (μVrms)	Package
BH7649KS2	7.5 to 9.5	34	23	0 (6.75MHz)	-30 (27MHz)	-3/-6/0/+3/+6	-0.5 (24kHz)	-26 (96kHz)	-6/0	20	SQFP-T52

Other

Isolation Amplifier											
Part No.	Supply Voltage (V)	Circuit Current (mA)	Amplifier Gain (dB)	Freq. Chara. (dB)	Channel	Input Type	Video Driver	Input Impedance (kΩ)	CMRR (dB)	Max. Output Level (V _{P-P})	Package
BH7673G	4.5 to 5.5	4.8	0	0 (10MHz)	1	Bias	—	150	60	3.8	SSOP5

Audio Converters

Audio Codec

Audio Codec												
Part No.	Supply Voltage (V)	ADC	DAC	Microphone Input	Speaker Output		Headphone Output	Filter		ALC	Package	Automotive Grade AEC-Q100
		Channel/bit	Channel/bit		Type	Monaural/Stereo		EQ	Notch			
BU26154MUV	HV _{DD} 2.7 to 5.5 LV _{DD} 2.7 to 3.6	1ch/24bit	2ch/24bit	1	AB/D	Monaural	Stereo	✓	✓	✓	VQFN040V6060	Preparing
BU26156RFS	HV _{DD} 2.7 to 5.5 LV _{DD} 2.7 to 3.6	2ch/24bit	2ch/24bit	2	AB/D	Stereo	Stereo	✓	✓	✓	HTSSOP-A44R	Preparing

Image Correction

Image Correction ICs for Panel											
Part No.	Supply Voltage(V)			Image Data Size	Control I/F	Input/Output Digital I/F	Image Adjustment	PWM Output	LVDS Transmitter	Package	Automotive Grade AEC-Q100
	V _{DD} Core	V _{DD} I/O	V _{DD} LVDS								
BU1573KV	1.4 to 1.6	2.7 to 3.6	—	Supports up to WVGA+ (864 × 480)	I ² C BUS	18bitRGB Interface BUS Interface	—	✓	—	VQFP64	Preparing
BU1523KV	1.65 to 1.95	3.0 to 3.6	3.0 to 3.6	Supports up to WVGA+ (864 × 480)	I ² C BUS	24bitRGB Interface 8bit YUV=4 : 2 : 2 ITU-R BT.656	✓	—	✓	VQFP100	Preparing

Video Encoders Built-in Image Correction										
Part No.	Supply Voltage(V)			Image Data Size	Control I/F	Input/Output Digital I/F	Fog Reduction	Video Encoder	Package	Automotive Grade AEC-Q100
	V _{DD} Core	V _{DD} I/O	AV _{DD}							
BU6521KV	1.4 to 1.6	2.7 to 3.6	2.7 to 3.6	ITU-R BT.656	I ² C BUS Serial EEPROM Interface	8bit YUV=4 : 2 : 2 ITU-R BT.656	✓	✓	VQFP48C	YES

Video LSIs

Video Decoder

(LAPIS Semiconductor products)

CVBS/S-video											
Part No.	Supply Voltage (V)	Input(Analog)		Output (LVTTTL)	Pixel Frequency	Crystal Oscillator Supported	Feature	Operating Temperature (°C)	Package	Halogen Free Support ^{#1}	Automotive Grade ^{#2}
		Terminal	Type								
ML86101A	3.3/1.5	CVBS×4 or CVBS×2+S-video×1 or S-video×2	NTSC PAL SECAM	ITU-R BT.656 YCbCr 8bit	12.2727MHz, 13.5MHz, 14.3181MHz, 14.75MHz	✓	Simple, small	-40 to +85	TQFP48	✓	YES
ML86V7668A	3.3/2.5	CVBS×4 or CVBS×1+S-video×3	NTSC PAL SECAM	ITU-R BT.656 YCbCr 8/16bit RGB 18bit	12.2727MHz, 13.5MHz	—	RGB output	-40 to +85	TQFP100	✓	YES

CVBS/S-video/Component/RGB											
ML86V7675	3.3/1.5	CVBS×4 +(Comp or S-video)×1 +Comp×1	NTSC PAL SECAM	ITU-R BT.656 YCbCr 8bit	7.9930MHz to 33.333MHz	✓	WVGA, EGA analog RGB supported	-40 to +85	TQFP64	✓	YES

*1 : A check mark of halogen free support means that we will be able to ship out the halogen free products. For details, please inquire to the sales.
*2 : Please inquire to the sales for AEC-Q100.

Video Encoder

(LAPIS Semiconductor products)

CVBS											
Part No.	Supply Voltage (V)	Input(LVTTTL)	Output(Analog)		Pixel Frequency	Crystal Oscillator Supported	Feature	Operating Temperature (°C)	Package	Halogen Free Support ^{#1}	Automotive Grade ^{#2}
			Terminal	Type							
ML86V76580	3.3/1.8	ITU-R BT.656 YCbCr 8bit	CVBS	NTSC PAL	12.2727MHz, 13.5MHz, 14.3181MHz, 14.75MHz	—	75Ω drive	-40 to +85	TQFP48 WCSP25	✓ ✓	YES —
New ML86640	3.3	ITU-R BT.656 YCbCr 8/16/24bit RGB 24bit	CVBS	NTSC PAL	13.5MHz, 27MHz, 54MHz	—	75Ω drive P/I conversion	-40 to +105	TQFP48	✓	YES

CVBS/S-video/Component/RGB											
ML86V7655	3.3/2.5	ITU-R BT.656 YCbCr 8/16/24bit RGB 24bit	CVBS S-video Component	NTSC PAL	12.2727MHz, 13.5MHz, 14.3181MHz, 14.75MHz, 18MHz	—	I/P, P/I conversion	-40 to +85	TQFP100	✓	YES

*1 : A check mark of halogen free support means that we will be able to ship out the halogen free products. For details, please inquire to the sales.
*2 : Please inquire to the sales for AEC-Q100.

Video Interface

(LAPIS Semiconductor products)

LVTTTL/LVDS/MIPI Video Interface										
Part No.	Supply Voltage (V)	Input (LVTTTL/LVDS/MIPI)	Output (LVTTTL/LVDS/MIPI)	Feature	Operating Temperature (°C)	Package	Halogen Free Support ^{#1}	Automotive Grade ^{#2}		
ML86790	1.8 to 3.3 1.5	MIPI-CSI2(2Lane) YUV422-8bit 650Mbps/Lane Max.	MIPI-CSI2(2Lane) YUV422-8bit 650Mbps/Lane Max. YCbCr 16bit 81MHz(typ.)	MIPI-CSI2 receiver/transmitter, MIPI to LVTTTL translate	-20 to +85	WCSP63	✓	—		
☆ML86795	1.8 to 3.3 1.5	ITU-R BT.656 Single/Dual LVDS 4ch (RGB 18/24bit) MIPI-CSI2 (RGB565/888, YUV422-8bit) 1Gbps/Lane Max.	ITU-R BT.656 YCbCr 16bit Single/Dual LVDS 4ch (RGB 18/24bit) MIPI-CSI2 (RGB565/888, YUV422-8bit) 1Gbps/Lane Max.	LVTTTL/LVDS/MIPI-CSI2 I/F LVTTTL/LVDS/MIPI to LVTTTL/LVDS/MIPI translate MIPI Virtual Channel	-40 to +105	WQFN64	✓	YES		

*1 : A check mark of halogen free support means that we will be able to ship out the halogen free products. For details, please inquire to the sales.
*2 : Please inquire to the sales for AEC-Q100.

☆ : Under Development

Display Controller Series for Small to Medium-Sized TFT LCD

(LAPIS Semiconductor products)

T-CON, Video Decoder Included													
Part No.	Supply Voltage (V)	Input(Analog)		Input (LVTTTL/LVDS/MIPI)	Output (LVTTTL/LVDS/MIPI)	Resolution	OSD	MCU	Feature	Operating Temperature (°C)	Package	Halogen Free Support ^{*1}	Automotive Grade ^{*2}
		Terminal	Type										
ML86V8201	3.3/1.5	CVBS×2 or S-video×1	NTSC PAL SECAM	ITU-R BT.656 YCbCr 8/16/24bit RGB 18/24bit	ITU-R BT.656 YCbCr 8bit RGB 18/24bit	QVGA to WVGA	Line	—	Rear camera function Image quality adjustment	-40 to +85	TQFP100	✓	YES
ML86203	3.3/1.5	CVBS×1	NTSC PAL	ITU-R BT.656 YCbCr 8/16/24bit RGB 18/24bit	ITU-R BT.656 YCbCr 8bit LVDS 4ch (RGB 18/24bit)	VGA to WXGA	—	—	Rear camera function WXGA panel support Image quality adjustment	-40 to +85	TQFP80	✓	YES
ML86207	3.3/1.5	CVBS×2	NTSC PAL	ITU-R BT.656 YCbCr 8/16/24bit RGB 18/24bit + LVDS 4ch (RGB 18/24bit)	ITU-R BT.656 YCbCr 8bit RGB 18/24bit LVDS 4ch (RGB 18/24bit)	VGA to WXGA	Text Line	—	LVTTTL/LVDS I/F Digital video input×2 WXGA panel support Rear camera function Image quality adjustment OSD function	-40 to +85	TQFP100	✓	YES
ML86287	3.3/1.5	CVBS×2	NTSC PAL	ITU-R BT.656 YCbCr 8/16/24bit RGB 18/24bit + LVDS 4ch (RGB 18/24bit)	ITU-R BT.656 YCbCr 8bit RGB 18/24bit LVDS 4ch (RGB 18/24bit)	VGA to WXGA	Text Line	—	LVTTTL/LVDS I/F Digital video input×2 WXGA panel support Rear camera function Picture in Picture Image quality adjustment OSD, ROM-OSD function	-40 to +85	TQFP128	✓	YES
☆ML86209	3.3/1.5	CVBS single×2 or differential×1	NTSC PAL	ITU-R BT.656 ITU-R BT.1120 like YCbCr 8/16bit Single/Dual LVDS 4ch (RGB 18/24bit) MIPI-CS12 (RGB 565/888, YUV422-8bit) 1Gbps/Lane Max.	ITU-R BT.656 or MIPI-CS12 (RGB565/888, YUV422-8bit) 1Gbps/Lane Max. + Single/Dual LVDS 4ch (RGB 18/24bit)	VGA to Full HD	Text Line	—	LVTTTL/LVDS/MIPI-CS12 I/F Digital video input×4 Full HD panel support Rear camera function Image quality adjustment OSD, ROM-OSD function	-40 to +85	TQFP128	✓	YES
☆ML86289	3.3/1.5	CVBS single×2 or differential×1	NTSC PAL	ITU-R BT.656 ITU-R BT.1120 like YCbCr 8/16bit Single/Dual LVDS 4ch (RGB 18/24bit) MIPI-CS12 (RGB 565/888, YUV422-8bit) 1Gbps/Lane Max.	ITU-R BT.656 or MIPI-CS12 (RGB565/888, YUV422-8bit) 1Gbps/Lane Max. + Single/Dual LVDS 4ch (RGB 18/24bit)	VGA to Full HD	Text Line	—	LVTTTL/LVDS/MIPI-CS12 I/F Digital video input×4 Full HD panel support Rear camera function Picture in Picture Image quality adjustment OSD, ROM-OSD function	-40 to +85	TQFP128	✓	YES
ML86V8202C	3.3/1.8	CVBS×2 or +(Comp or S-video)×1 +Comp×1	NTSC PAL SECAM	ITU-R BT.656 YCbCr 8/16/24bit RGB 18/24bit	ITU-R BT.656 style YCbCr 8/16/24bit RGB 18/24bit	QVGA to WVGA	—	—	Component video support Image quality adjustment	-40 to +85	TQFP100	✓	YES
ML86V8207	3.3/2.5	CVBS×4 or CVBS×3 or +(Comp or S-video)×1 or CVBS×2+S-video×1 +Comp or S-video×1	NTSC PAL SECAM	ITU-R BT.656 YCbCr 8/16/24bit RGB 18/24bit	RGB 18/24bit	QVGA to WVGA	Text Line	—	OSD function	-40 to +85	LQFP144	✓	YES
ML86240	3.3/1.5	CVBS×4 or CVBS×2 or +(Comp or S-video)×1 +Comp×1	NTSC PAL SECAM	ITU-R BT.656 YCbCr 8/16/24bit RGB 18/24bit 2ch	ITU-R BT.656 YCbCr 8bit RGB 18/24bit	QVGA to WVGA	Text Line	—	Component video support Digital video input×2 Rear camera function Image quality adjustment OSD function	-40 to +85	BGA144	—	YES
New ML86241	3.3/1.5 (1.8)	CVBS×4 or CVBS×2 or +(Comp or S-video)×1 +Comp×1	NTSC PAL SECAM	ITU-R BT.656 YCbCr 8/16/24bit RGB 18/24bit + LVDS 4ch (RGB 18/24bit)	ITU-R BT.656 YCbCr 8/16bit + RGB 18/24bit YCbCr 16bit LVDS 4ch (RGB 18/24bit)	QVGA to WXGA	Text Line	—	Component video support LVTTTL/LVDS I/F Digital video input×2 WXGA panel support Rear camera function Image quality adjustment OSD, ROM-OSD function	-40 to +85	BGA144	—	YES
TCON, Image Adjustment Functions Included													
Part No.	Supply Voltage (V)	Input(Analog)		Input (LVTTTL)	Output (LVTTTL)	Resolution	OSD	MCU	Feature	Operating Temperature (°C)	Package	Halogen Free Support ^{*1}	Automotive Grade ^{*2}
		Terminal	Type										
ML86V8101	3.3	—	—	RGB 18bit	RGB 18bit	QVGA to QHD	—	—	Image quality adjustment function	-40 to +85	TQFP64	✓	YES
ML86V8102	3.3	—	—	RGB 18/24bit	RGB 18/24bit	QVGA to QHD	—	—	RGB 24 bits supported Image quality adjustment function	-40 to +85	TQFP80	✓	YES
☆ML86173	3.3/1.5	—	—	ITU-R BT.656 YCbCr 8/10bit RGB 18/24bit Single/Dual LVDS 4ch (RGB 18/24bit)	Single/Dual LVDS 4ch (RGB 18/24bit)	WVGA to H 2880(Max.) V 1080(Max.) (Pixel rate 160MHz Max.)	Text	—	LVTTTL/LVDS I/F H 2880(Max.) V 1080(Max.) (Pixel rate 160MHz Max.) Image quality adjustment OSD function ROM OSD function (30windows, 2layers) Frequency conversion function	-40 to +85	TQFP100	✓	YES
Video Decoder, 8051MCU Included													
ML86V8401	3.3/1.8	CVBS×3 or CVBS×2 +S-video×1	NTSC PAL SECAM	ITU-R BT.656 YCbCr 8/16bit RGB 18/24bit	ITU-R BT.656 RGB 18/24bit	QVGA to WVGA	Text	8051 (8bit)	System control MCU installed	-40 to +85	TQFP100	—	YES

*1: A check mark of halogen free support means that we will be able to ship out the halogen free products. For details, please inquire to the sales.
 *2: Please inquire to the sales for AEC-Q100.

☆: Under Development



ICs

Speech Synthesis LSI

CONTENTS

- Speech Synthesis LSI with Built-in Large-capacity P2ROM™**(LAPIS Semiconductor products) ... P. A106
- Speech Synthesis LSI with Built-in Medium/Small-capacity Flash/Mask ROM**(LAPIS Semiconductor products) ... P. A106
- Speech Synthesis LSI with External Memory**(LAPIS Semiconductor products) ... P. A107

A

Speech Synthesis LSI

Speech Synthesis LSI with Built-in Large-capacity P2ROM™ (LAPIS Semiconductor products)

I ² C Interface 2ch Simultaneous Playback Speaker Amplifier Installed														
Part No.	Operating Voltage (V)	Operating Frequency (MHz)	Operating Temperature (°C)	ROM Capacity (bit)	Number of Phrases	Maximum Playback Time(sec.) ^{*1}	CPU I/F	SP Amp. Output(W)/Class	Number of Mixing (Internal)(ch)	DAC (bit)	Others	Package	Halogen Free Support ^{*5}	Automotive Grade
ML22863	2.7 to 3.6 or 4.5 to 5.5	4.096	-40 to +85	P2ROM™ 4M	4096 ^{*2}	258	I ² C	0.7/AB-class	2	16	—	SSOP30	✓	—
ML22864	2.7 to 3.6 or 4.5 to 5.5	4.096	-40 to +85	P2ROM™ 8M	4096 ^{*2}	520	I ² C	0.7/AB-class	2	16	—	SSOP30	✓	—
ML22865	2.7 to 3.6 or 4.5 to 5.5	4.096	-40 to +85	P2ROM™ 16M	4096 ^{*2}	1044	I ² C	0.7/AB-class	2	16	—	SSOP30	✓	—
I ² C Interface Speech-speed and Pitch Conversion Function Installed Speaker Amplifier Installed														
ML22763	2.7 to 3.6 or 4.5 to 5.5	4.096	-40 to +85	P2ROM™ 4M	4096 ^{*2}	258	I ² C	0.7/AB-class	1	16	Speech-speed and pitch conversion	SSOP30	✓	—
ML22764	2.7 to 3.6 or 4.5 to 5.5	4.096	-40 to +85	P2ROM™ 8M	4096 ^{*2}	520	I ² C	0.7/AB-class	1	16	Speech-speed and pitch conversion	SSOP30	✓	—
ML22765	2.7 to 3.6 or 4.5 to 5.5	4.096	-40 to +85	P2ROM™ 16M	4096 ^{*2}	1044	I ² C	0.7/AB-class	1	16	Speech-speed and pitch conversion	SSOP30	✓	—
Clock Synchronous Serial Interface 2ch Simultaneous Playback Speaker Amplifier Installed														
ML22823	2.7 to 3.6 or 4.5 to 5.5	4.096	-40 to +85	P2ROM™ 4M	4096 ^{*2}	258	Clock synchronous serial	0.7/AB-class	2	16	—	SSOP30	✓	—
ML22824	2.7 to 3.6 or 4.5 to 5.5	4.096	-40 to +85	P2ROM™ 8M	4096 ^{*2}	520	Clock synchronous serial	0.7/AB-class	2	16	—	SSOP30	✓	—
ML22825	2.7 to 3.6 or 4.5 to 5.5	4.096	-40 to +85	P2ROM™ 16M	4096 ^{*2}	1044	Clock synchronous serial	0.7/AB-class	2	16	—	SSOP30	✓	—
Clock Synchronous Serial Interface Speech-speed and Pitch Conversion Function Installed Speaker Amplifier Installed														
ML22723	2.7 to 3.6 or 4.5 to 5.5	4.096	-40 to +85	P2ROM™ 4M	4096 ^{*2}	258	Clock synchronous serial	0.7/AB-class	1	16	Speech-speed and pitch conversion	SSOP30	✓	—
ML22724	2.7 to 3.6 or 4.5 to 5.5	4.096	-40 to +85	P2ROM™ 8M	4096 ^{*2}	520	Clock synchronous serial	0.7/AB-class	1	16	Speech-speed and pitch conversion	SSOP30	✓	—
ML22725	2.7 to 3.6 or 4.5 to 5.5	4.096	-40 to +85	P2ROM™ 16M	4096 ^{*2}	1044	Clock synchronous serial	0.7/AB-class	1	16	Speech-speed and pitch conversion	SSOP30	✓	—
Clock Synchronous Interface														
ML22802	2.7 to 3.6	4.096	-20 to +85	P2ROM™ 2M	512 ^{*3}	131	Clock synchronous serial	—	1	12	—	SSOP30	✓	—
ML22804	2.7 to 3.6	4.096	-20 to +85	P2ROM™ 4M	1024 ^{*4}	262	Clock synchronous serial	—	1	12	—	SSOP30	✓	—
ML22808	2.7 to 3.6	4.096	-20 to +85	P2ROM™ 8M	1024 ^{*4}	524	Clock synchronous serial	—	1	12	—	SSOP30	✓	—

*1: Maximum playback time when the sampling frequency is 4kHz in ADPCM2. *2: 1024 phrases (1 bank) × 4 banks *3: 256 phrases (1 bank) × 2 banks *4: 256 phrases (1 bank) × 4 banks
 *5: A check mark of halogen free support means that we will be able to ship out the halogen free products. For details, please inquire to the sales.

Speech Synthesis LSI with Built-in Medium/Small-capacity Flash/Mask ROM (LAPIS Semiconductor products)

Clock Synchronous Serial Interface 4ch Simultaneous Playback Speaker Amplifier Installed														
Part No.	Operating Voltage (V)	Operating Frequency (MHz)	Operating Temperature (°C)	ROM Capacity (bit)	Number of Phrases	Maximum Playback Time(sec.)	CPU I/F	SP Amp. Output(W)/Class	Number of Mixing (Internal)(ch)	DAC (bit)	Others	Package	Halogen Free Support ^{*3}	Automotive Grade
ML22562	2.7 to 5.5	4.096	-40 to +85	Mask 2M	1024	98 ^{*1}	Clock synchronization serial	1.0/AB-class	4	16	Fail safe	SSOP30	✓	—
ML22563/ ML22Q563	2.7 to 5.5	4.096	-40 to +85	Mask/Flash 4M	1024	201 ^{*1}	Clock synchronization serial	1.0/AB-class	4	16	Fail safe	SSOP30	✓	—
Clock Synchronous Serial Interface 4ch Simultaneous Playback Speaker Amplifier Installed Support for 105°C														
ML22572	2.7 to 5.5	4.096	-40 to +105	Mask 2M	1024	98 ^{*1}	Clock synchronization serial	1.0/AB-class	4	16	Fail safe	SSOP30	✓	YES
ML22573/ ML22Q573	2.7 to 5.5	4.096	-40 to +105	Mask/Flash 4M	1024	201 ^{*1}	Clock synchronization serial	1.0/AB-class	4	16	Fail safe	SSOP30	✓	YES
ML22Q553	4.5 to 5.5	4.096	-40 to +105	Mask 4M	1024	201 ^{*1}	Clock synchronization serial	1.0/AB-class	4	16	Speaker terminal short circuit detection function	SSOP30	✓	YES
Clock Synchronous Serial Interface Speaker Amplifier Installed														
ML22321/ ML22Q321	2.3 to 5.5	4.096	-40 to +85	Mask/Flash 920K	62	43 ^{*1}	Clock synchronization serial	1.0/AB-class	1	16	Disconnection detection/ Temperature protection circuit / Analog volume control	SSOP30	✓	YES
Clock Synchronous Serial Interface D-class Speaker Amplifier Installed														
ML22Q374	2.0 to 5.5	4.096 (Built-in)	-40 to +85	Flash 692K	30	27 ^{*2}	Clock synchronization serial	1.0/D-class	1	—	Disconnection/Short circuit detection Built-in oscillator	SSOP16	—	YES
I ² C Interface D-class Speaker Amplifier Installed														
ML22Q394	2.0 to 5.5	4.096 (Built-in)	-40 to +85	Flash 692K	30	27 ^{*2}	I ² C	1.0/D-class	1	—	Disconnection/Short circuit detection Built-in oscillator	SSOP16	—	YES

*1: Maximum playback time when the sampling frequency is 6.4kHz in HQ-ADPCM. *2: Maximum playback time when the sampling frequency is 6.4kHz in ADPCM2.
 *3: A check mark of halogen free support means that we will be able to ship out the halogen free products. For details, please inquire to the sales.
 *4: Please inquire to the sales for AEC-Q100.

Speech Synthesis LSI with External Memory (LAPIS Semiconductor products)

4ch Simultaneous Playback Serial External Memory Speaker Amplifier Installed														
Part No.	Operating Voltage (V)	Operating Frequency (MHz)	Operating Temperature (°C)	ROM Capacity (bit)	Number of Phrase	Maximum Playback Time	CPU I/F	SP Amp. Output(W)/Class	Number of Mixing (Internal) (ch)	DAC (bit)	Others	Package	Halogen Free Support*6	Automotive Grade*7
ML22460	2.7 to 5.5	4.096	-40 to +85	External maximum 128M	1024	139min.*1	I ² C	0.7/AB-class	4	16	—	SSOP30	✓	—
ML22420	2.7 to 5.5	4.096	-40 to +85	External maximum 128M	1024	139min.*1	Clock synchronization Serial	0.7/AB-class	4	16	—	SSOP30	✓	—
4ch Simultaneous Playback Built-in Mask ROM+Serial External Memory Speaker Amplifier Installed Support for 105°C														
ML22594	4.5 to 5.5	4.096	-40 to +105	Mask 6M*4 External maximum 128M	1024*5 (Built-in 512/ External 512)	Built-in 303sec.*2 External 109min.*3	Clock synchronization Serial	1.0/AB-class	4	16	Speaker terminal short circuit detection function	SSOP30	✓	YES

*1: Maximum playback time when the sampling frequency is 4kHz in ADPCM2. *2: Maximum playback time when the sampling frequency is 6.4kHz in HQ-ADPCM.

*3: With an external memory module(Max. 128Mbit). Maximum playback time when the sampling frequency is 6.4kHz in HQ-ADPCM.

*4: Mask's built-in ROM is 6Mbit and an external memory module(Max. 128Mbit) can be connected.

*5: Total of mask's internal 512 phrases and external memory's 512 phrases.

*6: A check mark of halogen free support means that we will be able to ship out the halogen free products. For details, please inquire to the sales.

*7: Please inquire to the sales for AEC-Q100.



ICs

Microcontroller

CONTENTS

High Functionality, High Performance & Low Power Tough MCU(High Noise Immunity) ... P. A110
16bit ML621000 series(LAPIS Semiconductor products) P. A110
Low Power Tough MCU(High Noise Immunity) ... P. A114
8bit ML6101xx(LAPIS Semiconductor products) P. A114
16bit ML6201xx(LAPIS Semiconductor products) P. A114
High Performance & Ultra Low Power MCU ... P. A116
16bit ML6205xx/ML6204xx(LAPIS Semiconductor products) P. A116
32bit ML6304xx(Cortex-M)(LAPIS Semiconductor products) P. A116
Ultra Low Operating Voltage & Ultra Low Power MCU ... P. A116
8bit ML6104xx(LAPIS Semiconductor products) P. A116
Built-in Speech Output Function MCU ... P. A120
8bit ML6103xx(LAPIS Semiconductor products) P. A120
Sensor Hub MCU P. A120
8bit ML61079x(LAPIS Semiconductor products) P. A120
32bit ML63079x(LAPIS Semiconductor products) P. A120

A

Microcontroller

High Functionality, High Performance & Low Power Tough MCU(High Noise Immunity)

16bit ML621000 series

Standard Type 1200 Group 16bit Low Power Tough MCU(Industrial Grade)

Part No.	Operating Voltage (V)	Operating Conditions				ROM/RAM				Functions/Features			
		Operating Frequency(Max.)		Minimum Instruction Execution Time	Current Consumption (Typ.@HALT)	Operating Temperature (°C)	ROM Type	ROM Capacity (Byte)	Data Flash Capacity (Byte)	RAM Capacity (Byte)	Port		
		Low Speed	High Speed								Input	Output	Input/Output
New ML62Q1223A	1.6 to 5.5	32.768kHz (Internal RC oscillation)	24MHz (PLL oscillation)	41ns/30.5µs	2.8µA (Internal RC oscillation)	-40 to +105	Flash	16K	2K	2K	—	—	12
New ML62Q1224A	1.6 to 5.5	32.768kHz (Internal RC oscillation)	24MHz (PLL oscillation)	41ns/30.5µs	2.8µA (Internal RC oscillation)	-40 to +105	Flash	24K	2K	2K	—	—	12
New ML62Q1225A	1.6 to 5.5	32.768kHz (Internal RC oscillation)	24MHz (PLL oscillation)	41ns/30.5µs	2.8µA (Internal RC oscillation)	-40 to +105	Flash	32K	2K	2K	—	—	12
New ML62Q1233A	1.6 to 5.5	32.768kHz (Internal RC oscillation)	24MHz (PLL oscillation)	41ns/30.5µs	2.8µA (Internal RC oscillation)	-40 to +105	Flash	16K	2K	2K	—	—	16
New ML62Q1234A	1.6 to 5.5	32.768kHz (Internal RC oscillation)	24MHz (PLL oscillation)	41ns/30.5µs	2.8µA (Internal RC oscillation)	-40 to +105	Flash	24K	2K	2K	—	—	16
New ML62Q1235A	1.6 to 5.5	32.768kHz (Internal RC oscillation)	24MHz (PLL oscillation)	41ns/30.5µs	2.8µA (Internal RC oscillation)	-40 to +105	Flash	32K	2K	2K	—	—	16
New ML62Q1245A	1.6 to 5.5	32.768kHz (Internal RC oscillation)	24MHz (PLL oscillation)	41ns/30.5µs	2.8µA (Internal RC oscillation)	-40 to +105	Flash	32K	2K	4K	—	—	20
New ML62Q1246A	1.6 to 5.5	32.768kHz (Internal RC oscillation)	24MHz (PLL oscillation)	41ns/30.5µs	2.8µA (Internal RC oscillation)	-40 to +105	Flash	48K	2K	4K	—	—	20
New ML62Q1247A	1.6 to 5.5	32.768kHz (Internal RC oscillation)	24MHz (PLL oscillation)	41ns/30.5µs	2.8µA (Internal RC oscillation)	-40 to +105	Flash	64K	2K	4K	—	—	20
New ML62Q1265A	1.6 to 5.5	32.768kHz (Internal RC oscillation)	24MHz (PLL oscillation)	41ns/30.5µs	2.8µA (Internal RC oscillation)	-40 to +105	Flash	32K	2K	4K	—	—	28
New ML62Q1266A	1.6 to 5.5	32.768kHz (Internal RC oscillation)	24MHz (PLL oscillation)	41ns/30.5µs	2.8µA (Internal RC oscillation)	-40 to +105	Flash	48K	2K	4K	—	—	28
New ML62Q1267A	1.6 to 5.5	32.768kHz (Internal RC oscillation)	24MHz (PLL oscillation)	41ns/30.5µs	2.8µA (Internal RC oscillation)	-40 to +105	Flash	64K	2K	4K	—	—	28

Standard Type 1400 Group 16bit Low Power Tough MCU(Industrial Grade)

New ML62Q1430	1.6 to 5.5	32.768kHz (Internal RC oscillation/Crystal oscillation)	24MHz (PLL oscillation)	41ns/30.5µs	3.4µA (Internal RC oscillation)	-40 to +105	Flash	32K	2K	4K	—	—	42
New ML62Q1431	1.6 to 5.5	32.768kHz (Internal RC oscillation/Crystal oscillation)	24MHz (PLL oscillation)	41ns/30.5µs	3.4µA (Internal RC oscillation)	-40 to +105	Flash	48K	2K	4K	—	—	42
New ML62Q1432	1.6 to 5.5	32.768kHz (Internal RC oscillation/Crystal oscillation)	24MHz (PLL oscillation)	41ns/30.5µs	3.4µA (Internal RC oscillation)	-40 to +105	Flash	64K	2K	4K	—	—	42
New ML62Q1440	1.6 to 5.5	32.768kHz (Internal RC oscillation/Crystal oscillation)	24MHz (PLL oscillation)	41ns/30.5µs	3.4µA (Internal RC oscillation)	-40 to +105	Flash	32K	2K	4K	—	—	46
New ML62Q1441	1.6 to 5.5	32.768kHz (Internal RC oscillation/Crystal oscillation)	24MHz (PLL oscillation)	41ns/30.5µs	3.4µA (Internal RC oscillation)	-40 to +105	Flash	48K	2K	4K	—	—	46
New ML62Q1442	1.6 to 5.5	32.768kHz (Internal RC oscillation/Crystal oscillation)	24MHz (PLL oscillation)	41ns/30.5µs	3.4µA (Internal RC oscillation)	-40 to +105	Flash	64K	2K	4K	—	—	46
New ML62Q1450	1.6 to 5.5	32.768kHz (Internal RC oscillation/Crystal oscillation)	24MHz (PLL oscillation)	41ns/30.5µs	3.4µA (Internal RC oscillation)	-40 to +105	Flash	32K	2K	4K	—	—	58
New ML62Q1451	1.6 to 5.5	32.768kHz (Internal RC oscillation/Crystal oscillation)	24MHz (PLL oscillation)	41ns/30.5µs	3.4µA (Internal RC oscillation)	-40 to +105	Flash	48K	2K	4K	—	—	58
New ML62Q1452	1.6 to 5.5	32.768kHz (Internal RC oscillation/Crystal oscillation)	24MHz (PLL oscillation)	41ns/30.5µs	3.4µA (Internal RC oscillation)	-40 to +105	Flash	64K	2K	4K	—	—	58

Standard Type 1500 Group 16bit Low Power Tough MCU(Industrial Grade)

☆ ML62Q1533	1.6 to 5.5	32.768kHz (Internal RC oscillation/Crystal oscillation)	24MHz (PLL oscillation)	41ns/30.5µs	(TBD) (Internal RC oscillation)	-40 to +105	Flash	96K	4K	8K	—	—	42
☆ ML62Q1534	1.6 to 5.5	32.768kHz (Internal RC oscillation/Crystal oscillation)	24MHz (PLL oscillation)	41ns/30.5µs	(TBD) (Internal RC oscillation)	-40 to +105	Flash	128K	4K	8K	—	—	42
☆ ML62Q1543	1.6 to 5.5	32.768kHz (Internal RC oscillation/Crystal oscillation)	24MHz (PLL oscillation)	41ns/30.5µs	(TBD) (Internal RC oscillation)	-40 to +105	Flash	96K	4K	8K	—	—	42
☆ ML62Q1544	1.6 to 5.5	32.768kHz (Internal RC oscillation/Crystal oscillation)	24MHz (PLL oscillation)	41ns/30.5µs	(TBD) (Internal RC oscillation)	-40 to +105	Flash	128K	4K	8K	—	—	46
☆ ML62Q1553	1.6 to 5.5	32.768kHz (Internal RC oscillation/Crystal oscillation)	24MHz (PLL oscillation)	41ns/30.5µs	(TBD) (Internal RC oscillation)	-40 to +105	Flash	96K	4K	8K	—	—	46
☆ ML62Q1554	1.6 to 5.5	32.768kHz (Internal RC oscillation/Crystal oscillation)	24MHz (PLL oscillation)	41ns/30.5µs	(TBD) (Internal RC oscillation)	-40 to +105	Flash	128K	4K	8K	—	—	46
☆ ML62Q1555	1.6 to 5.5	32.768kHz (Internal RC oscillation/Crystal oscillation)	24MHz (PLL oscillation)	41ns/30.5µs	(TBD) (Internal RC oscillation)	-40 to +105	Flash	160K	4K	16K	—	—	58
☆ ML62Q1556	1.6 to 5.5	32.768kHz (Internal RC oscillation/Crystal oscillation)	24MHz (PLL oscillation)	41ns/30.5µs	(TBD) (Internal RC oscillation)	-40 to +105	Flash	192K	4K	16K	—	—	58
☆ ML62Q1557	1.6 to 5.5	32.768kHz (Internal RC oscillation/Crystal oscillation)	24MHz (PLL oscillation)	41ns/30.5µs	(TBD) (Internal RC oscillation)	-40 to +105	Flash	256K	4K	16K	—	—	58
☆ ML62Q1563	1.6 to 5.5	32.768kHz (Internal RC oscillation/Crystal oscillation)	24MHz (PLL oscillation)	41ns/30.5µs	(TBD) (Internal RC oscillation)	-40 to +105	Flash	96K	4K	16K	—	—	72
☆ ML62Q1564	1.6 to 5.5	32.768kHz (Internal RC oscillation/Crystal oscillation)	24MHz (PLL oscillation)	41ns/30.5µs	(TBD) (Internal RC oscillation)	-40 to +105	Flash	128K	4K	16K	—	—	72
☆ ML62Q1565	1.6 to 5.5	32.768kHz (Internal RC oscillation/Crystal oscillation)	24MHz (PLL oscillation)	41ns/30.5µs	(TBD) (Internal RC oscillation)	-40 to +105	Flash	160K	4K	16K	—	—	72
☆ ML62Q1566	1.6 to 5.5	32.768kHz (Internal RC oscillation/Crystal oscillation)	24MHz (PLL oscillation)	41ns/30.5µs	(TBD) (Internal RC oscillation)	-40 to +105	Flash	192K	4K	16K	—	—	72
☆ ML62Q1567	1.6 to 5.5	32.768kHz (Internal RC oscillation/Crystal oscillation)	24MHz (PLL oscillation)	41ns/30.5µs	(TBD) (Internal RC oscillation)	-40 to +105	Flash	256K	4K	16K	—	—	72
☆ ML62Q1573	1.6 to 5.5	32.768kHz (Internal RC oscillation/Crystal oscillation)	24MHz (PLL oscillation)	41ns/30.5µs	(TBD) (Internal RC oscillation)	-40 to +105	Flash	96K	4K	16K	—	—	92
☆ ML62Q1574	1.6 to 5.5	32.768kHz (Internal RC oscillation/Crystal oscillation)	24MHz (PLL oscillation)	41ns/30.5µs	(TBD) (Internal RC oscillation)	-40 to +105	Flash	128K	4K	16K	—	—	92
☆ ML62Q1575	1.6 to 5.5	32.768kHz (Internal RC oscillation/Crystal oscillation)	24MHz (PLL oscillation)	41ns/30.5µs	(TBD) (Internal RC oscillation)	-40 to +105	Flash	160K	4K	16K	—	—	92
☆ ML62Q1576	1.6 to 5.5	32.768kHz (Internal RC oscillation/Crystal oscillation)	24MHz (PLL oscillation)	41ns/30.5µs	(TBD) (Internal RC oscillation)	-40 to +105	Flash	192K	4K	16K	—	—	92
☆ ML62Q1577	1.6 to 5.5	32.768kHz (Internal RC oscillation/Crystal oscillation)	24MHz (PLL oscillation)	41ns/30.5µs	(TBD) (Internal RC oscillation)	-40 to +105	Flash	256K	4K	16K	—	—	92

A check mark of halogen free support means that we will be able to ship out the halogen free products. For details, please inquire to the sales.

Built-in LCD Driver Segments type 1600 Group 16bit Low Power Tough MCU(Industrial Grade)

Part No.	Operating Conditions						ROM/RAM				Functions/Features		
	Operating Voltage (V)	Operating Frequency(Max.)		Minimum Instruction Execution Time	Current Consumption (Typ.@HALT)	Operating Temperature (°C)	ROM Type	ROM Capacity (Byte)	Data Flash Capacity (Byte)	RAM Capacity (Byte)	Port		
		Low Speed	High Speed								Input	Output	Input/Output
New ML62Q1600	1.6 to 5.5	32.768kHz (Internal RC oscillation/Crystal oscillation)	24MHz (PLL oscillation)	41ns/ 30.5µs	3.4µA (Internal RC oscillation)	-40 to +105	Flash	32K	2K	4K	—	—	37
New ML62Q1601	1.6 to 5.5	32.768kHz (Internal RC oscillation/Crystal oscillation)	24MHz (PLL oscillation)	41ns/ 30.5µs	3.4µA (Internal RC oscillation)	-40 to +105	Flash	48K	2K	4K	—	—	37
New ML62Q1602	1.6 to 5.5	32.768kHz (Internal RC oscillation/Crystal oscillation)	24MHz (PLL oscillation)	41ns/ 30.5µs	3.4µA (Internal RC oscillation)	-40 to +105	Flash	64K	2K	4K	—	—	37
New ML62Q1610	1.6 to 5.5	32.768kHz (Internal RC oscillation/Crystal oscillation)	24MHz (PLL oscillation)	41ns/ 30.5µs	3.4µA (Internal RC oscillation)	-40 to +105	Flash	32K	2K	4K	—	—	41
New ML62Q1611	1.6 to 5.5	32.768kHz (Internal RC oscillation/Crystal oscillation)	24MHz (PLL oscillation)	41ns/ 30.5µs	3.4µA (Internal RC oscillation)	-40 to +105	Flash	48K	2K	4K	—	—	41
New ML62Q1612	1.6 to 5.5	32.768kHz (Internal RC oscillation/Crystal oscillation)	24MHz (PLL oscillation)	41ns/ 30.5µs	3.4µA (Internal RC oscillation)	-40 to +105	Flash	64K	2K	4K	—	—	41
New ML62Q1620	1.6 to 5.5	32.768kHz (Internal RC oscillation/Crystal oscillation)	24MHz (PLL oscillation)	41ns/ 30.5µs	3.4µA (Internal RC oscillation)	-40 to +105	Flash	32K	2K	4K	—	—	53
New ML62Q1621	1.6 to 5.5	32.768kHz (Internal RC oscillation/Crystal oscillation)	24MHz (PLL oscillation)	41ns/ 30.5µs	3.4µA (Internal RC oscillation)	-40 to +105	Flash	48K	2K	4K	—	—	53
New ML62Q1622	1.6 to 5.5	32.768kHz (Internal RC oscillation/Crystal oscillation)	24MHz (PLL oscillation)	41ns/ 30.5µs	3.4µA (Internal RC oscillation)	-40 to +105	Flash	64K	2K	4K	—	—	53

Built-in LCD Driver Segments type 1700 Group 16bit Low Power Tough MCU(Industrial Grade)

☆ ML62Q1703	1.6 to 5.5	32.768kHz (Internal RC oscillation/Crystal oscillation)	24MHz (PLL oscillation)	41ns/ 30.5µs	(TBD) (Internal RC oscillation)	-40 to +105	Flash	96K	4K	8K	—	—	37
☆ ML62Q1704	1.6 to 5.5	32.768kHz (Internal RC oscillation/Crystal oscillation)	24MHz (PLL oscillation)	41ns/ 30.5µs	(TBD) (Internal RC oscillation)	-40 to +105	Flash	128K	4K	8K	—	—	37
☆ ML62Q1713	1.6 to 5.5	32.768kHz (Internal RC oscillation/Crystal oscillation)	24MHz (PLL oscillation)	41ns/ 30.5µs	(TBD) (Internal RC oscillation)	-40 to +105	Flash	96K	4K	8K	—	—	41
☆ ML62Q1714	1.6 to 5.5	32.768kHz (Internal RC oscillation/Crystal oscillation)	24MHz (PLL oscillation)	41ns/ 30.5µs	(TBD) (Internal RC oscillation)	-40 to +105	Flash	128K	4K	8K	—	—	41
☆ ML62Q1723	1.6 to 5.5	32.768kHz (Internal RC oscillation/Crystal oscillation)	24MHz (PLL oscillation)	41ns/ 30.5µs	(TBD) (Internal RC oscillation)	-40 to +105	Flash	96K	4K	8K	—	—	53
☆ ML62Q1724	1.6 to 5.5	32.768kHz (Internal RC oscillation/Crystal oscillation)	24MHz (PLL oscillation)	41ns/ 30.5µs	(TBD) (Internal RC oscillation)	-40 to +105	Flash	128K	4K	8K	—	—	53
☆ ML62Q1725	1.6 to 5.5	32.768kHz (Internal RC oscillation/Crystal oscillation)	24MHz (PLL oscillation)	41ns/ 30.5µs	(TBD) (Internal RC oscillation)	-40 to +105	Flash	160K	4K	16K	—	—	53
☆ ML62Q1726	1.6 to 5.5	32.768kHz (Internal RC oscillation/Crystal oscillation)	24MHz (PLL oscillation)	41ns/ 30.5µs	(TBD) (Internal RC oscillation)	-40 to +105	Flash	192K	4K	16K	—	—	53
☆ ML62Q1727	1.6 to 5.5	32.768kHz (Internal RC oscillation/Crystal oscillation)	24MHz (PLL oscillation)	41ns/ 30.5µs	(TBD) (Internal RC oscillation)	-40 to +105	Flash	256K	4K	16K	—	—	53
☆ ML62Q1733	1.6 to 5.5	32.768kHz (Internal RC oscillation/Crystal oscillation)	24MHz (PLL oscillation)	41ns/ 30.5µs	(TBD) (Internal RC oscillation)	-40 to +105	Flash	96K	4K	16K	—	—	67
☆ ML62Q1734	1.6 to 5.5	32.768kHz (Internal RC oscillation/Crystal oscillation)	24MHz (PLL oscillation)	41ns/ 30.5µs	(TBD) (Internal RC oscillation)	-40 to +105	Flash	128K	4K	16K	—	—	67
☆ ML62Q1735	1.6 to 5.5	32.768kHz (Internal RC oscillation/Crystal oscillation)	24MHz (PLL oscillation)	41ns/ 30.5µs	(TBD) (Internal RC oscillation)	-40 to +105	Flash	160K	4K	16K	—	—	67
☆ ML62Q1736	1.6 to 5.5	32.768kHz (Internal RC oscillation/Crystal oscillation)	24MHz (PLL oscillation)	41ns/ 30.5µs	(TBD) (Internal RC oscillation)	-40 to +105	Flash	192K	4K	16K	—	—	67
☆ ML62Q1737	1.6 to 5.5	32.768kHz (Internal RC oscillation/Crystal oscillation)	24MHz (PLL oscillation)	41ns/ 30.5µs	(TBD) (Internal RC oscillation)	-40 to +105	Flash	256K	4K	16K	—	—	67
☆ ML62Q1743	1.6 to 5.5	32.768kHz (Internal RC oscillation/Crystal oscillation)	24MHz (PLL oscillation)	41ns/ 30.5µs	(TBD) (Internal RC oscillation)	-40 to +105	Flash	96K	4K	16K	—	—	87
☆ ML62Q1744	1.6 to 5.5	32.768kHz (Internal RC oscillation/Crystal oscillation)	24MHz (PLL oscillation)	41ns/ 30.5µs	(TBD) (Internal RC oscillation)	-40 to +105	Flash	128K	4K	16K	—	—	87
☆ ML62Q1745	1.6 to 5.5	32.768kHz (Internal RC oscillation/Crystal oscillation)	24MHz (PLL oscillation)	41ns/ 30.5µs	(TBD) (Internal RC oscillation)	-40 to +105	Flash	160K	4K	16K	—	—	87
☆ ML62Q1746	1.6 to 5.5	32.768kHz (Internal RC oscillation/Crystal oscillation)	24MHz (PLL oscillation)	41ns/ 30.5µs	(TBD) (Internal RC oscillation)	-40 to +105	Flash	192K	4K	16K	—	—	87
☆ ML62Q1747	1.6 to 5.5	32.768kHz (Internal RC oscillation/Crystal oscillation)	24MHz (PLL oscillation)	41ns/ 30.5µs	(TBD) (Internal RC oscillation)	-40 to +105	Flash	256K	4K	16K	—	—	87

A check mark of halogen free support means that we will be able to ship out the halogen free products. For details, please inquire to the sales.

Low Power Tough MCU(High Noise Immunity)

8bit ML6101xx

Standard type 8bit Low Power Tough MCU(Industrial Grade)

Part No.	Operating Conditions					ROM/RAM				Functions/Features			
	Operating Voltage (V)	Operating Frequency(Max.)		Minimum Instruction Execution Time	Current Consumption (Typ.@HALT)	Operating Temperature (°C)	ROM Type	ROM Capacity (Byte)	Data Flash Capacity (Byte)	RAM Capacity (Byte)	Port		
		Low Speed	High Speed								Input	Output	Input/Output
ML610Q101	2.7 to 5.5	32.768kHz (Internal RC oscillation)	8.192MHz	0.122µs/30.5µs	—	-40 to +85	Flash	4K	—	256	—	—	11
ML610Q102	2.7 to 5.5	32.768kHz (Internal RC oscillation)	8.192MHz	0.122µs/30.5µs	—	-40 to +85	Flash	6K	—	256	—	—	11
ML610Q111	2.7 to 5.5	32.768kHz (Internal RC oscillation)	8.192MHz	0.122µs/30.5µs	—	-40 to +105	Flash	24K	4K	2K	—	—	15
ML610Q112	2.7 to 5.5	32.768kHz (Internal RC oscillation)	8.192MHz	0.122µs/30.5µs	—	-40 to +105	Flash	32K	4K	4K	—	—	25

Built-in LCD Driver Segments type 8bit Low Power Tough MCU

ML610Q172	2.2 to 5.5	32.768kHz (Internal RC oscillation/ Crystal oscillation)	8.192MHz	0.122µs/30.5µs	2.0µA	-40 to +85	Flash	128K	2K	4K	6	2	37
ML610Q173	2.2 to 5.5	32.768kHz (Internal RC oscillation/ Crystal oscillation)	8.192MHz	0.122µs/30.5µs	2.0µA	-40 to +85	Flash	128K	2K	4K	6	2	37
ML610Q174	2.2 to 5.5	32.768kHz (Internal RC oscillation/ Crystal oscillation)	8.192MHz	0.122µs/30.5µs	2.0µA	-40 to +85	Flash	128K	2K	4K	6	6	49
ML610Q178	2.2 to 5.5	32.768kHz (Internal RC oscillation/ Crystal oscillation)	8.192MHz	0.122µs/30.5µs	2.0µA	-40 to +85	Flash	128K	—	4K	7	8	59

16bit ML6201xx

Standard type 16bit Low Power Tough MCU(Industrial Grade)

Part No.	Operating Conditions					ROM/RAM				Functions/Features			
	Operating Voltage (V)	Operating Frequency(Max.)		Minimum Instruction Execution Time	Current Consumption (Typ.@HALT)	Operating Temperature (°C)	ROM Type	ROM Capacity (Byte)	Data Flash Capacity (Byte)	RAM Capacity (Byte)	Port		
		Low Speed	High Speed								Input	Output	Input/Output
ML620Q131/B*	1.6 to 5.5	32.768kHz (Internal RC oscillation)	16MHz	62.5 ns/30.5µs	3.5µA (Internal RC oscillation)	-40 to +105	Flash	8K	2K	2K	1	—	10
ML620Q132/B*	1.6 to 5.5	32.768kHz (Internal RC oscillation)	16MHz	62.5 ns/30.5µs	3.5µA (Internal RC oscillation)	-40 to +105	Flash	16K	2K	2K	1	—	10
ML620Q133/B*	1.6 to 5.5	32.768kHz (Internal RC oscillation)	16MHz	62.5 ns/30.5µs	3.5µA (Internal RC oscillation)	-40 to +105	Flash	24K	2K	2K	1	—	10
ML620Q134/B*	1.6 to 5.5	32.768kHz (Internal RC oscillation)	16MHz	62.5 ns/30.5µs	3.5µA (Internal RC oscillation)	-40 to +105	Flash	8K	2K	2K	1	—	14
ML620Q135/B*	1.6 to 5.5	32.768kHz (Internal RC oscillation)	16MHz	62.5 ns/30.5µs	3.5µA (Internal RC oscillation)	-40 to +105	Flash	16K	2K	2K	1	—	14
ML620Q136/B*	1.6 to 5.5	32.768kHz (Internal RC oscillation)	16MHz	62.5 ns/30.5µs	3.5µA (Internal RC oscillation)	-40 to +105	Flash	24K	2K	2K	1	—	14
ML620Q151A/B*	1.8 to 5.5	32.768kHz (Internal RC oscillation/ Crystal oscillation)	8.192MHz	0.122µs/30.5µs	2.5 (Crystal oscillation) 3.5 (Internal RC oscillation)	-40 to +105	Flash	32K	2K	2K	5 (Use crystal oscillation) 6 (Not use crystal oscillation)	4	30 (Use crystal oscillation) 31 (Not use crystal oscillation)
ML620Q152A/B*	1.8 to 5.5	32.768kHz (Internal RC oscillation/ Crystal oscillation)	8.192MHz	0.122µs/30.5µs	2.5 (Crystal oscillation) 3.5 (Internal RC oscillation)	-40 to +105	Flash	48K	2K	2K	5 (Use crystal oscillation) 6 (Not use crystal oscillation)	4	30 (Use crystal oscillation) 31 (Not use crystal oscillation)
ML620Q153A/B*	1.8 to 5.5	32.768kHz (Internal RC oscillation/ Crystal oscillation)	8.192MHz	0.122µs/30.5µs	2.5 (Crystal oscillation) 3.5 (Internal RC oscillation)	-40 to +105	Flash	64K	2K	2K	5 (Use crystal oscillation) 6 (Not use crystal oscillation)	4	30 (Use crystal oscillation) 31 (Not use crystal oscillation)
ML620Q154A/B*	1.8 to 5.5	32.768kHz (Internal RC oscillation/ Crystal oscillation)	8.192MHz	0.122µs/30.5µs	2.5 (Crystal oscillation) 3.5 (Internal RC oscillation)	-40 to +105	Flash	32K	2K	2K	6 (Use crystal oscillation) 7 (Not use crystal oscillation)	4	33 (Use crystal oscillation) 34 (Not use crystal oscillation)
ML620Q155A/B*	1.8 to 5.5	32.768kHz (Internal RC oscillation/ Crystal oscillation)	8.192MHz	0.122µs/30.5µs	2.5 (Crystal oscillation) 3.5 (Internal RC oscillation)	-40 to +105	Flash	48K	2K	2K	6 (Use crystal oscillation) 7 (Not use crystal oscillation)	4	33 (Use crystal oscillation) 34 (Not use crystal oscillation)
ML620Q156A/B*	1.8 to 5.5	32.768kHz (Internal RC oscillation/ Crystal oscillation)	8.192MHz	0.122µs/30.5µs	2.5 (Crystal oscillation) 3.5 (Internal RC oscillation)	-40 to +105	Flash	64K	2K	2K	6 (Use crystal oscillation) 7 (Not use crystal oscillation)	4	33 (Use crystal oscillation) 34 (Not use crystal oscillation)
ML620Q157A/B*	1.8 to 5.5	32.768kHz (Internal RC oscillation/ Crystal oscillation)	8.192MHz	0.122µs/30.5µs	2.5 (Crystal oscillation) 3.5 (Internal RC oscillation)	-40 to +105	Flash	32K	2K	2K	6 (Use crystal oscillation) 7 (Not use crystal oscillation)	4	45 (Use crystal oscillation) 46 (Not use crystal oscillation)
ML620Q158A/B*	1.8 to 5.5	32.768kHz (Internal RC oscillation/ Crystal oscillation)	8.192MHz	0.122µs/30.5µs	2.5 (Crystal oscillation) 3.5 (Internal RC oscillation)	-40 to +105	Flash	48K	2K	2K	6 (Use crystal oscillation) 7 (Not use crystal oscillation)	4	45 (Use crystal oscillation) 46 (Not use crystal oscillation)
ML620Q159A/B*	1.8 to 5.5	32.768kHz (Internal RC oscillation/ Crystal oscillation)	8.192MHz	0.122µs/30.5µs	2.5 (Crystal oscillation) 3.5 (Internal RC oscillation)	-40 to +105	Flash	64K	2K	2K	6 (Use crystal oscillation) 7 (Not use crystal oscillation)	4	45 (Use crystal oscillation) 46 (Not use crystal oscillation)

* : Recommended "B" version for New Design.

A check mark of halogen free support means that we will be able to ship out the halogen free products. For details, please inquire to the sales.

(LAPIS Semiconductor products)

Functions/Features															Notes	Package	Chip Support	Halogen Free Support	Industrial Grade
8bit Timer	16bit Timer	PWM	WDT	ADC (method)	Serial Port			Supply Voltage Detection	LCD Driver	External Interrupt Sources	Others								
					FC	SSIO	UART												
6 (16bit×3)	—	16bit×1 (with dead time)	1	10bit×6 (SA type)	—	—	1	VLS×2	—	5	Analog comparator×2	—	P-SSOP16-0225-0.65 P-WQFN16-0404-0.50	—	✓	✓			
6 (16bit×3)	—	16bit×1 (with dead time)	1	10bit×6 (SA type)	—	—	1	VLS×2	—	5	Analog comparator×2	—	P-SSOP16-0225-0.65 P-WQFN16-0404-0.50	—	✓	✓			
6 (16bit×3)	—	16bit×4 (Complementary type)	1	10bit×6 (SA type)	1	1	2	VLS×2	—	7	Analog comparator×2	—	P-TSSOP20-0225-0.65	—	✓	✓			
6 (16bit×3)	—	16bit×4 (Complementary type)	1	10bit×8 (SA type)	1	1	2	VLS×2	—	7	Analog comparator×2	—	P-LQFP32-0707-0.80	—	✓	✓			
6 (16bit×3)	—	16bit×3 (Supports IGBT control)	1	10bit×12 (SA type)	1	2	2 (Half Duplex×2)	BLD×1	Max. 96dot 24seg.×4com.	4	Low speed frequency correction	—	QFP64-P-1414-0.80	—	✓	—			
6 (16bit×3)	—	16bit×3 (Supports IGBT control)	1	10bit×8 (SA type)	1	2	2 (Half Duplex×2)	BLD×1	Max. 96dot 24seg.×4com.	4	Low speed frequency correction/ Analog comparator	—	QFP64-P-1414-0.80	—	✓	—			
6 (16bit×3)	—	16bit×3 (Supports IGBT control)	1	10bit×12 (SA type)	1	2	2 (Half Duplex×2)	BLD×1	Max. 128dot 32seg.×4com.	4	Low speed frequency correction/ Analog comparator	—	QFP80-P-1420-0.80	—	✓	—			
6 (16bit×3)	—	16bit×2 (Supports IGBT control)	1	10bit×16 (SA type)	1	2	2 (Half Duplex×2)	BLD×1	Max. 160dot 40seg.×4com.	5	Low speed frequency correction	—	P-QFP100-1420-0.65	—	✓	—			

(LAPIS Semiconductor products)

Functions/Features															Notes	Package	Chip Support	Halogen Free Support	Industrial Grade
8bit Timer	16bit Timer	PWM	WDT	ADC (method)	Serial Port			Supply Voltage Detection	LCD Driver	External Interrupt Sources	Others								
					FC	SSIO	UART												
10 (16bit×5)	—	16bit×1 (with dead time)	1	10bit×6 (SA type)	Master×1 Slave×1	1	1	VLS×1	—	5	Analog comparator×2	—	P-SSOP16-0225-0.65 P-WQFN16-0404-0.50	—	✓	✓			
10 (16bit×5)	—	16bit×1 (with dead time)	1	10bit×6 (SA type)	Master×1 Slave×1	1	1	VLS×1	—	5	Analog comparator×2	—	P-SSOP16-0225-0.65 P-WQFN16-0404-0.50	—	✓	✓			
10 (16bit×5)	—	16bit×1 (with dead time)	1	10bit×6 (SA type)	Master×1 Slave×1	1	1	VLS×1	—	5	Analog comparator×2	—	P-SSOP16-0225-0.65 P-WQFN16-0404-0.50	—	✓	✓			
10 (16bit×5)	—	16bit×1 (with dead time)	1	10bit×8 (SA type)	Master×1 Slave×1	1	1	VLS×1	—	5	Analog comparator×2	—	P-TSSOP20-0225-0.65	—	✓	✓			
10 (16bit×5)	—	16bit×1 (with dead time)	1	10bit×8 (SA type)	Master×1 Slave×1	1	1	VLS×1	—	5	Analog comparator×2	—	P-TSSOP20-0225-0.65	—	✓	✓			
10 (16bit×5)	—	16bit×1 (with dead time)	1	10bit×8 (SA type)	Master×1 Slave×1	1	1	VLS×1	—	5	Analog comparator×2	—	P-TSSOP20-0225-0.65	—	✓	✓			
2 (16bit×1)	4	16bit×4 (Complementary type)	1	10bit×12 (SA type)	1	1	2 (Half Duplex×2, Full Duplex×1)	LLD×1	—	7	Analog comparator	—	P-TQFP48-0707-0.50	—	✓	✓			
2 (16bit×1)	4	16bit×4 (Complementary type)	1	10bit×12 (SA type)	1	1	2 (Half Duplex×2, Full Duplex×1)	LLD×1	—	7	Analog comparator	—	P-TQFP48-0707-0.50	—	✓	✓			
2 (16bit×1)	4	16bit×4 (Complementary type)	1	10bit×12 (SA type)	1	1	2 (Half Duplex×2, Full Duplex×1)	LLD×1	—	7	Analog comparator	—	P-TQFP48-0707-0.50	—	✓	✓			
2 (16bit×1)	4	16bit×4 (Complementary type)	1	10bit×12 (SA type)	1	1	2 (Half Duplex×2, Full Duplex×1)	LLD×1	—	8	Analog comparator	—	P-TQFP52-1010-0.65	—	✓	✓			
2 (16bit×1)	4	16bit×4 (Complementary type)	1	10bit×12 (SA type)	1	1	2 (Half Duplex×2, Full Duplex×1)	LLD×1	—	8	Analog comparator	—	P-TQFP52-1010-0.65	—	✓	✓			
2 (16bit×1)	4	16bit×4 (Complementary type)	1	10bit×12 (SA type)	1	1	2 (Half Duplex×2, Full Duplex×1)	LLD×1	—	8	Analog comparator	—	P-TQFP52-1010-0.65	—	✓	✓			
2 (16bit×1)	4	16bit×4 (Complementary type)	1	10bit×12 (SA type)	1	1	2 (Half Duplex×2, Full Duplex×1)	LLD×1	—	8	Analog comparator	—	P-QFP64-1414-0.80 P-TQFP64-1010-0.50	—	✓	✓			
2 (16bit×1)	4	16bit×4 (Complementary type)	1	10bit×12 (SA type)	1	1	2 (Half Duplex×2, Full Duplex×1)	LLD×1	—	8	Analog comparator	—	P-QFP64-1414-0.80 P-TQFP64-1010-0.50	—	✓	✓			
2 (16bit×1)	4	16bit×4 (Complementary type)	1	10bit×12 (SA type)	1	1	2 (Half Duplex×2, Full Duplex×1)	LLD×1	—	8	Analog comparator	—	P-QFP64-1414-0.80 P-TQFP64-1010-0.50	—	✓	✓			

A
Microcontroller



High Performance & Ultra Low Power MCU

16bit ML6205xx/ML6204xx

Standard type 16bit Low Power MCU(Industrial Grade)																	
Part No.	Operating Conditions						ROM/RAM				Functions/Features						
	Operating Voltage (V)	Operating Frequency(Max.)		Minimum Instruction Execution Time	Current Consumption (Typ.@HALT)	Operating Temperature (°C)	ROM Type	ROM Capacity (Byte)	Data Flash Capacity (Byte)	RAM Capacity (Byte)	Co-processor for Multiplication and Division	Port			8bit Timer	16bit Timer	
		Low Speed	High Speed									Input	Output	Input/Output			
ML620Q503H	1.8 to 5.5	32.768kHz (Internal RC oscillation/ Crystal oscillation/ External input)		16MHz (Internal RC oscillation/ Crystal oscillation/ External input)	62.5 ns / 30.5µs	0.45µA	-40 to +85	Flash	32K	2K	2K	✓	2	—	36	8 (16bit×4)	4
ML620Q504H	1.8 to 5.5	32.768kHz (Internal RC oscillation/ Crystal oscillation/ External input)		16MHz (Internal RC oscillation/ Crystal oscillation/ External input)	62.5 ns / 30.5µs	0.45µA	-40 to +85	Flash	64K	2K	6K	✓	2	—	36	8 (16bit×4)	4

Built-in LCD Driver Dot Matrix type 16bit Low Power MCU

ML620Q416A	1.8 to 3.6	32.768kHz (Internal RC oscillation/ Crystal oscillation)		16MHz (Internal RC oscillation/PLL)	62.5 ns / 30.5µs	0.38µA	-40 to +85	Flash	128K	4K	16K	✓	—	—	52	8 (16bit×4)	4
ML620Q418A	1.8 to 3.6	32.768kHz (Internal RC oscillation/ Crystal oscillation)		16MHz (Internal RC oscillation/PLL)	62.5 ns / 30.5µs	0.38µA	-40 to +85	Flash	256K	4K	16K	✓	—	—	52	8 (16bit×4)	4

A check mark of halogen free support means that we will be able to ship out the halogen free products. For details, please inquire to the sales.

32bit ML6304xx(Cortex-M)

Built-in LCD Driver Dot Matrix type 32bit Low Power MCU(Industrial Grade)																	
Part No.	Operating Conditions						ROM/RAM				Functions/Features						
	Operating Voltage (V)	Operating Frequency(Max.)		Minimum Instruction Execution Time	Current Consumption (Typ.@HALT)	Operating Temperature (°C)	ROM Type	ROM Capacity (Byte)	Data Flash Capacity (Byte)	RAM Capacity (Byte)	Co-processor for Multiplication and Division	Port			8bit Timer	16bit Timer	
		Low Speed	High Speed									Input	Output	Input/Output			
New ML630Q464	1.8 to 3.6	32.768kHz (Internal RC oscillation/ Crystal oscillation)		16MHz(Internal RC oscillation) 24MHz(PLL)	41.7ns / 30.5µs	0.8µA	-40 to +85	Flash	64K	2K	8K	✓	—	—	38	8 (16bit×4)	4
New ML630Q466	1.8 to 3.6	32.768kHz (Internal RC oscillation/ Crystal oscillation)		16MHz(Internal RC oscillation) 24MHz(PLL)	41.7ns / 30.5µs	0.8µA	-40 to +85	Flash	128K	2K	16K	✓	—	—	38	8 (16bit×4)	4

A check mark of halogen free support means that we will be able to ship out the halogen free products. For details, please inquire to the sales.

Ultra Low Operating Voltage & Ultra Low Power MCU

8bit ML6104xx

Standard type 8bit Low Power MCU																		
Part No.	Operating Conditions						ROM/RAM				Functions/Features							
	Operating Voltage (V)	Operating Frequency(Max.)		Minimum Instruction Execution Time	Current Consumption (Typ.@HALT)	Operating Temperature (°C)	ROM Type	ROM Capacity (Byte)	Data Flash Capacity (Byte)	RAM Capacity (Byte)	Port			8bit Timer	1kHz Timer	PWM	Capture	WDT
		Low Speed	High Speed								Input	Output	Input/Output					
ML610482	1.1 to 3.6	32.768kHz (Crystal oscillation)		0.244µs/2µs/ 30.5µs	0.5µA	-20 to +70	Mask	64K	—	4K	6	4	22	4 (16bit×2)	—	16bit×1	—	1
ML610Q482	1.1 to 3.6	32.768kHz (Crystal oscillation)		0.244µs/2µs/ 30.5µs	0.5µA	-20 to +70	Flash	64K	—	4K	6	4	22	4 (16bit×2)	—	16bit×1	—	1

Standard type 8bit Low Power MCU(Industrial Grade)

ML610482P	1.1 to 3.6	32.768kHz (Crystal oscillation)		0.244µs/2µs/ 30.5µs	0.5µA	-40 to +85	Mask	64K	—	4K	6	4	22	4 (16bit×2)	—	16bit×1	—	1
ML610Q482P	1.1 to 3.6	32.768kHz (Crystal oscillation)		0.244µs/2µs/ 30.5µs	0.5µA	-40 to +85	Flash	64K	—	4K	6	4	22	4 (16bit×2)	—	16bit×1	—	1

Built-in LCD Driver Dot Matrix type 8bit Low Power MCU

ML610421	1.1 to 3.6	32.768kHz (Crystal oscillation)		0.244µs/2µs/ 30.5µs	0.5µA	-20 to +70	Mask	32K	—	2K	6	3	22	4 (16bit×2)	1	16bit×1	2	1	
ML610Q421	1.1 to 3.6	32.768kHz (Crystal oscillation)		0.244µs/2µs/ 30.5µs	0.5µA	-20 to +70	Flash	32K	—	2K	6	3	22	4 (16bit×2)	1	16bit×1	2	1	
ML610Q422	1.1 to 3.6	32.768kHz (Crystal oscillation)		0.244µs/2µs/ 30.5µs	0.5µA	-20 to +70	Flash	32K	—	2K	6	3	14	4 (16bit×2)	1	16bit×1	2	1	
ML610426	1.1 to 3.6	32.768kHz (Crystal oscillation)		1MHz	1µs/ 30.5µs	0.5µA	-20 to +70	Mask	40K	—	2K	5	—	7	4 (16bit×2)	1	16bit×1	—	1
ML610Q426	1.1 to 3.6	32.768kHz (Crystal oscillation)		1MHz	1µs/ 30.5µs	0.5µA	-20 to +70	Flash	40K	—	2K	5	—	7	4 (16bit×2)	1	16bit×1	—	1
ML610Q426C	1.1 to 3.6	32.768kHz (Crystal oscillation)		1MHz	1µs/ 30.5µs	0.5µA	-20 to +70	Flash	40K	—	2K	7	—	13	4 (16bit×2)	1	16bit×1	—	1
ML610Q428	1.1 to 3.6	32.768kHz (Crystal oscillation)		0.096MHz	0.244µs/0.5µs/ 2MHz	0.5µA	-20 to +70	Flash	48K	—	4K	6	3	14	2 (16bit×1)	1	16bit×3	—	1
ML610429	1.1 to 3.6	32.768kHz (Crystal oscillation)		0.096MHz	0.244µs/0.5µs/ 2MHz	0.5µA	-20 to +70	Mask	48K	—	4K	10	3	20	2 (16bit×1)	1	16bit×3	—	1
ML610Q429	1.1 to 3.6	32.768kHz (Crystal oscillation)		0.096MHz	0.244µs/0.5µs/ 2MHz	0.5µA	-20 to +70	Flash	48K	—	4K	10	3	20	2 (16bit×1)	1	16bit×3	—	1
ML610Q431	1.1 to 3.6	32.768kHz (Crystal oscillation)		0.096MHz	0.244µs/2µs/ 30.5µs	0.5µA	-20 to +70	Flash	64K	—	3K	6	3	22	4 (16bit×2)	1	16bit×1	2	1
ML610Q431A	1.1 to 3.6	32.768kHz (Crystal oscillation)		0.096MHz	0.244µs/2µs/ 30.5µs	0.5µA	-20 to +70	Flash	64K	—	3K	6	3	22	4 (16bit×2)	1	16bit×1	2	1
ML610Q432	1.1 to 3.6	32.768kHz (Crystal oscillation)		0.096MHz	0.244µs/2µs/ 30.5µs	0.5µA	-20 to +70	Flash	64K	—	3K	6	3	14	4 (16bit×2)	1	16bit×1	2	1
ML610Q432A	1.1 to 3.6	32.768kHz (Crystal oscillation)		0.096MHz	0.244µs/2µs/ 30.5µs	0.5µA	-20 to +70	Flash	64K	—	3K	6	3	14	4 (16bit×2)	1	16bit×1	2	1
ML610Q435	1.1 to 3.6	32.768kHz (Crystal oscillation)		0.096MHz	0.244µs/2µs/ 30.5µs	0.5µA	-20 to +70	Flash	96K	—	3K	6	3	22	4 (16bit×2)	1	16bit×1	2	1
ML610Q435A	1.1 to 3.6	32.768kHz (Crystal oscillation)		0.096MHz	0.244µs/2µs/ 30.5µs	0.5µA	-20 to +70	Flash	96K	—	3K	6	3	22	4 (16bit×2)	1	16bit×1	2	1
ML610Q436	1.1 to 3.6	32.768kHz (Crystal oscillation)		0.096MHz	0.244µs/2µs/ 30.5µs	0.5µA	-20 to +70	Flash	96K	—	3K	6	3	14	4 (16bit×2)	1	16bit×1	2	1
ML610Q436A	1.1 to 3.6	32.768kHz (Crystal oscillation)		0.096MHz	0.244µs/2µs/ 30.5µs	0.5µA	-20 to +70	Flash	96K	—	3K	6	3	14	4 (16bit×2)	1	16bit×1	2	1
ML610Q438	1.1 to 3.6	32.768kHz (Crystal oscillation)		0.096MHz	0.244µs/0.5µs/ 2MHz	0.5µA	-20 to +70	Flash	128K	—	7K	10	3	20	4 (16bit×2)	1	16bit×3	2	1
ML610Q439	1.1 to 3.6	32.768kHz (Crystal oscillation)		0.096MHz	0.244µs/0.5µs/ 30.5µs	0.5µA	-20 to +70	Flash	128K	—	7K	10	3	20	4 (16bit×2)	1	16bit×3	2	1

Built-in LCD Driver Dot Matrix type 8bit Low Power MCU(Industrial Grade)

ML610Q421P	1.1 to 3.6	32.768kHz (Crystal oscillation)		0.244µs/2µs/ 30.5µs	0.5µA	-40 to +85	Flash	32K	—	2K	6	3	22	4 (16bit×2)	1	16bit×1	2	1
ML610Q422P	1.1 to 3.6	32.768kHz (Crystal oscillation)		0.244µs/2µs/ 30.5µs	0.5µA	-40 to +85	Flash	32K	—	2K	6	3	14	4 (16bit×2)	1	16bit×1	2	1
ML610Q439P	1.1 to 3.6	32.768kHz (Crystal oscillation)		0.244µs/0.5µs/ 30.5µs	0.5µA	-40 to +85	Flash	128K	—	7K	10	3	20	4 (16bit×2)	1	16bit×3	2	1

A check mark of halogen free support means that we will be able to ship out the halogen free products. For details, please inquire to the sales.

(LAPIS Semiconductor products)

Functions/Features														Notes	Package	Chip Support	Halogen Free Support	Industrial Grade
PWM	Capture	WDT	ADC (method)	Serial Port			Supply Voltage Detection	LCD Driver	External Interrupt Sources	Others								
				I ² C	SSIO (SPI)	UART					USB							
16bit×4 (use 16bit timer)	16bit×4 (use 16bit timer)	1	24bit×2(RC type) 12bit×12(SA type)	2	2	2	—	VLS×1 LLD×1	—	8	Low speed frequency correction/ Analog comparator×2/Melody : Buzzer	—	P-TQFP48-0707-0.50	✓	✓	✓		
16bit×4 (use 16bit timer)	16bit×4 (use 16bit timer)	1	24bit×2(RC type) 12bit×12(SA type)	2	2	2	—	VLS×1 LLD×1	—	8	Low speed frequency correction/ Analog comparator×2/Melody : Buzzer	—	P-TQFP48-0707-0.50	✓	✓	✓		
16bit×4 (use 16bit timer)	16bit×4 (use 16bit timer)	1	24bit×2(RC type) 12bit×12(SA type)	3	2	3	—	VLS×1 LLD×1	Max. 2048dot 64seg.×32com.	8	Low speed frequency correction/ Analog comparator×2/ Melody : Buzzer/1kHz Timer	—	—	✓	✓	—		
16bit×4 (use 16bit timer)	16bit×4 (use 16bit timer)	1	24bit×2(RC type) 12bit×12(SA type)	3	2	3	—	VLS×1 LLD×1	Max. 2048dot 64seg.×32com.	8	Low speed frequency correction/ Analog comparator×2/ Melody : Buzzer/1kHz Timer	—	—	✓	✓	—		

(LAPIS Semiconductor products)

Functions/Features														Notes	Package	Chip Support	Halogen Free Support	Industrial Grade
PWM	Capture	WDT	ADC (method)	Serial Port			Supply Voltage Detection	LCD Driver	External Interrupt Sources	Others								
				I ² C	SSIO (SPI)	UART					USB							
16bit×4 (use 16bit timer)	16bit×4 (use 16bit timer)	1	24bit×2(RC type) 12bit×12(SA type)	2	2	2	1	VLS×1 LLD×1	Max. 400dot 50seg.×8com.	8	AES/Random generator/DMA/RTC/ Analog comparator×2/1kHz timer	—	P-TQFP100-1414-0.50	—	✓	✓		
16bit×4 (use 16bit timer)	16bit×4 (use 16bit timer)	1	24bit×2(RC type) 12bit×12(SA type)	2	2	2	1	VLS×1 LLD×1	Max. 400dot 50seg.×8com.	8	AES/Random generator/DMA/RTC/ Analog comparator×2/1kHz timer	—	P-TQFP100-1414-0.50	—	✓	✓		

(LAPIS Semiconductor products)

Functions/Features										Notes	Package	Chip Support	Halogen Free Support	Industrial Grade
ADC (method)	Serial Port			Supply Voltage Detection	LCD Driver	External Interrupt Sources	Others							
	I ² C	SSIO	UART											
24bit×2(RC type)	1	1	1	BLD×1	—	5	Low speed frequency correction /Buzzer	—	—	✓	✓	—		
24bit×2(RC type)	1	1	1	BLD×1	—	5	Low speed frequency correction /Buzzer	—	P-TQFP48-0707-0.50	✓	✓	—		
24bit×2(RC type)	1	1	1	BLD×1	—	5	Low speed frequency correction /Buzzer	—	—	✓	✓	✓		
24bit×2(RC type)	1	1	1	BLD×1	—	5	Low speed frequency correction /Buzzer	—	P-TQFP48-0707-0.50	✓	✓	✓		

24bit×2(RC type) 12bit×2(SA type)	1	1	1	BLD×1	Max. 400dot 50seg.×8com.	5	Low speed frequency correction/ Melody : Buzzer	—	—	✓	✓	—
24bit×2(RC type) 12bit×2(SA type)	1	1	1	BLD×1	Max. 400dot 50seg.×8com.	5	Low speed frequency correction/ Melody : Buzzer	—	P-TQFP120-1414-0.40	✓	✓	—
24bit×2(RC type) 12bit×2(SA type)	1	1	1	BLD×1	Max. 800dot 50seg.×16com.	5	Low speed frequency correction/ Melody : Buzzer	Low-speed scillation stop detect reset : enable	P-TQFP120-1414-0.40	✓	✓	—
16bit×1(RC type)	1	1	1	BLD×1	Max. 800dot 50seg.×16com.	5	Low speed frequency correction/Melody : Buzzer/ EL Driver/External input voltage detection	—	—	✓	✓	—
16bit×1(RC type)	1	1	1	BLD×1	Max. 800dot 50seg.×16com.	5	Low speed frequency correction/Melody : Buzzer/ EL Driver/External input voltage detection	—	—	✓	✓	—
16bit×1(RC type)	1	1	1	BLD×1	Max. 672dot 42seg.×16com.	8	Low speed frequency correction/Melody : Buzzer/ EL Driver/External input voltage detection	—	—	✓	✓	—
24bit×2(RC type)	1	1	1	BLD×1	Max. 1392dot 58seg.×24com.	5	Low speed frequency correction/ Melody : Buzzer	Selectable oscillation stop detection reset : function enable/disable according to software	TQFP128-P-1414-0.40	✓	✓	—
24bit×2(RC type)	1	1	1	BLD×1	Max. 512dot 64seg.×8com.	9	Low speed frequency correction/ Melody : Buzzer	Selectable oscillation stop detection reset : function enable/disable according to software	—	✓	✓	—
24bit×2(RC type)	1	1	1	BLD×1	Max. 512dot 64seg.×8com.	9	Low speed frequency correction/ Melody : Buzzer	Selectable oscillation stop detection reset : function enable/disable according to software	TQFP128-P-1414-0.40	✓	✓	—
24bit×2(RC type) 12bit×2(SA type)	1	1	1	BLD×1	Max. 1024dot 64seg.×16com.	5	RTC/Low speed frequency correction/ Melody : Buzzer	Low-speed scillation stop detect reset : enable	P-LQFP144-2020-0.50	✓	✓	—
24bit×2(RC type) 12bit×2(SA type)	1	1	1	BLD×1	Max. 1024dot 64seg.×16com.	5	RTC/Low speed frequency correction/ Melody : Buzzer	Low-speed scillation stop detect reset : disenable	—	✓	✓	—
24bit×2(RC type) 12bit×2(SA type)	1	1	1	BLD×1	Max. 1536dot 64seg.×24com.	5	RTC/Low speed frequency correction/ Melody : Buzzer	Low-speed scillation stop detect reset : enable	P-LQFP144-2020-0.50	✓	✓	—
24bit×2(RC type) 12bit×2(SA type)	1	1	1	BLD×1	Max. 1536dot 64seg.×24com.	5	RTC/Low speed frequency correction/ Melody : Buzzer	Low-speed scillation stop detect reset : disenable	P-LQFP144-2020-0.50	✓	✓	—
24bit×2(RC type) 12bit×2(SA type)	1	1	1	BLD×1	Max. 1344dot 56seg.×24com.	9	Low speed frequency correction/ Melody : Buzzer	Selectable oscillation stop detection reset : function enable/disable according to software	P-LQFP144-2020-0.50	✓	✓	—
24bit×2(RC type) 12bit×2(SA type)	1	1	1	BLD×1	Max. 1024dot 64seg.×16com.	9	Low speed frequency correction/ Melody : Buzzer	Selectable oscillation stop detection reset : function enable/disable according to software	—	✓	✓	—
24bit×2(RC type) 12bit×2(SA type)	1	1	1	BLD×1	Max. 400dot 50seg.×8com.	5	Low speed frequency correction/ Melody : Buzzer	—	P-TQFP120-1414-0.40	✓	✓	✓
24bit×2(RC type) 12bit×2(SA type)	1	1	1	BLD×1	Max. 800dot 50seg.×16com.	5	Low speed frequency correction/ Melody : Buzzer	Low-speed scillation stop detect reset : enable	P-TQFP120-1414-0.40	✓	✓	✓
24bit×2(RC type) 12bit×2(SA type)	1	1	1	BLD×1	Max. 1024dot 64seg.×16com.	9	Low speed frequency correction/ Melody : Buzzer	Selectable oscillation stop detection reset : function enable/disable according to software	P-LQFP144-2020-0.50	—	✓	✓



8bit ML6104xx

Built-in LCD Driver Segments type Low Power 8bit MCU

Part No.	Operating Conditions					ROM/RAM				Functions/Features								
	Operating Voltage (V)	Operating Frequency(Max.)		Minimum Instruction Execution Time	Current Consumption (Typ. @HALT)	Operating Temperature (°C)	ROM Type	ROM Capacity (Byte)	Data Flash Capacity (Byte)	RAM Capacity (Byte)	Port			8bit Timer	1kHz Timer	PWM	Capture	WDT
		Low Speed	High Speed								Input	Output	Input/Output					
ML610401	1.25 to 3.6	32.768kHz (Crystal oscillation)	500kHz	2μs/30.5μs	0.9μA	-20 to +70	Mask	6K	—	192	4	12	18	2 (16bit × 1)	—	—	2	1
ML610402	1.25 to 3.6	32.768kHz (Crystal oscillation)	500kHz	2μs/30.5μs	0.9μA	-20 to +70	Mask	6K	—	192	4	8	18	2 (16bit × 1)	—	—	2	1
ML610403	1.25 to 3.6	32.768kHz (Crystal oscillation)	500kHz	2μs/30.5μs	0.9μA	-20 to +70	Mask	6K	—	192	4	4	18	2 (16bit × 1)	—	—	2	1
ML610404	1.25 to 3.6	32.768kHz (Crystal oscillation)	2MHz	0.5μs/30.5μs	0.9μA	-20 to +70	Mask	8K	—	256	5	12	22	4 (16bit × 2)	—	16bit × 1	2	1
ML610405	1.25 to 3.6	32.768kHz (Crystal oscillation)	2MHz	0.5μs/30.5μs	0.9μA	-20 to +70	Mask	8K	—	256	5	8	22	4 (16bit × 2)	—	16bit × 1	2	1
ML610406	1.25 to 3.6	32.768kHz (Crystal oscillation)	2MHz	0.5μs/30.5μs	0.9μA	-20 to +70	Mask	8K	—	256	5	4	22	4 (16bit × 2)	—	16bit × 1	2	1
ML610407	1.25 to 3.6	32.768kHz (Crystal oscillation)	2MHz	0.5μs/30.5μs	0.9μA	-20 to +70	Mask	16K	—	1K	5	12	22	4 (16bit × 2)	—	16bit × 1	2	1
ML610Q407	1.25 to 3.6	32.768kHz (Crystal oscillation)	2MHz	0.5μs/30.5μs	0.9μA	-20 to +70	Flash	16K	—	1K	5	12	22	4 (16bit × 2)	—	16bit × 1	2	1
ML610Q407A	1.25 to 3.6	32.768kHz (Crystal oscillation)	2MHz	0.5μs/30.5μs	0.9μA	-20 to +70	Flash	16K	—	1K	5	12	22	4 (16bit × 2)	—	16bit × 1	2	1
ML610Q407D	1.25 to 3.6	32.768kHz (Crystal oscillation)	2MHz	0.5μs/30.5μs	0.9μA	-20 to +70	Flash	16K	—	1K	5	12	22	4 (16bit × 2)	—	16bit × 1	2	1
ML610408	1.25 to 3.6	32.768kHz (Crystal oscillation)	2MHz	0.5μs/30.5μs	0.9μA	-20 to +70	Mask	16K	—	1K	5	8	22	4 (16bit × 2)	—	16bit × 1	2	1
ML610Q408	1.25 to 3.6	32.768kHz (Crystal oscillation)	2MHz	0.5μs/30.5μs	0.9μA	-20 to +70	Flash	16K	—	1K	5	8	22	4 (16bit × 2)	—	16bit × 1	2	1
ML610409	1.25 to 3.6	32.768kHz (Crystal oscillation)	2MHz	0.5μs/30.5μs	0.9μA	-20 to +70	Mask	16K	—	1K	5	4	22	4 (16bit × 2)	—	16bit × 1	2	1
ML610Q409	1.25 to 3.6	32.768kHz (Crystal oscillation)	2MHz	0.5μs/30.5μs	0.9μA	-20 to +70	Flash	16K	—	1K	5	4	22	4 (16bit × 2)	—	16bit × 1	2	1
ML610Q409A	1.25 to 3.6	32.768kHz (Crystal oscillation)	2MHz	0.5μs/30.5μs	0.9μA	-20 to +70	Flash	16K	—	1K	5	4	22	4 (16bit × 2)	—	16bit × 1	2	1
ML610Q411	1.1 to 3.6	32.768kHz (Crystal oscillation)	500kHz	2μs/30.5μs	0.5μA	-20 to +70	Flash	16K	—	1K	6	3	22	4 (16bit × 2)	1	16bit × 1	2	1
ML610Q412	1.1 to 3.6	32.768kHz (Crystal oscillation)	500kHz	2μs/30.5μs	0.5μA	-20 to +70	Flash	16K	—	1K	6	3	14	4 (16bit × 2)	1	16bit × 1	2	1
ML610Q418	1.1 to 3.6	32.768kHz (Crystal oscillation)	4.096MHz 500kHz	0.244μs/2μs/30.5μs	1.1μA	-20 to +70	Flash	128K	4K	4K	6	3	18	4 (16bit × 2)	—	16bit × 1	2	1
ML610Q418C	1.1 to 3.6	32.768kHz (Crystal oscillation)	4.096MHz 500kHz	0.244μs/2μs/30.5μs	1.1μA	-20 to +70	Flash	128K	4K	4K	6	3	26	4 (16bit × 2)	—	16bit × 1	2	1
ML610Q419	1.1 to 3.6	32.768kHz (Crystal oscillation)	4.096MHz 500kHz	0.244μs/2μs/30.5μs	0.9μA	-20 to +70	Flash	64K	4K	2K	6	3	18	4 (16bit × 2)	—	16bit × 1	2	1
ML610Q419C	1.1 to 3.6	32.768kHz (Crystal oscillation)	4.096MHz 500kHz	0.244μs/2μs/30.5μs	0.9μA	-20 to +70	Flash	64K	4K	2K	6	3	26	4 (16bit × 2)	—	16bit × 1	2	1
ML610Q461	1.25 to 3.6	32.768kHz (Crystal oscillation)	2MHz 500kHz	0.5μs/2μs/30.5μs	0.9μA	-20 to +70	Flash	16K	—	1K	5	10	14	4 (16bit × 2)	—	16bit × 1	2	1
ML610Q462	1.25 to 3.6	32.768kHz (Crystal oscillation)	2MHz 500kHz	0.5μs/2μs/30.5μs	0.9μA	-20 to +70	Flash	16K	—	1K	5	6	14	4 (16bit × 2)	—	16bit × 1	2	1
ML610Q463	1.25 to 3.6	32.768kHz (Crystal oscillation)	2MHz 500kHz	0.5μs/2μs/30.5μs	0.9μA	-20 to +70	Flash	16K	—	1K	5	2	14	4 (16bit × 2)	—	16bit × 1	2	1
ML610Q477	1.25 to 3.6	32.768kHz (Crystal oscillation)	2MHz 500kHz	0.5μs/2μs/30.5μs	0.8μA	-20 to +70	Flash	24K	—	2K	4	10	15	6 (16bit × 3)	—	—	2	1
ML610Q478	1.25 to 3.6	32.768kHz (Crystal oscillation)	2MHz 500kHz	0.5μs/2μs/30.5μs	0.8μA	-20 to +70	Flash	24K	—	2K	4	6	15	6 (16bit × 3)	—	—	2	1
ML610Q479	1.25 to 3.6	32.768kHz (Crystal oscillation)	2MHz 500kHz	0.5μs/2μs/30.5μs	0.8μA	-20 to +70	Flash	24K	—	2K	4	2	15	6 (16bit × 3)	—	—	2	1

Built-in LCD Driver Segments type Low Power 8bit MCU(Industrial Grade)

ML610401P	1.25 to 3.6	32.768kHz (Crystal oscillation)	500kHz	2μs/30.5μs	0.9μA	-40 to +85	Mask	6K	—	192	4	12	18	2 (16bit × 1)	—	—	2	1
ML610402P	1.25 to 3.6	32.768kHz (Crystal oscillation)	500kHz	2μs/30.5μs	0.9μA	-40 to +85	Mask	6K	—	192	4	8	18	2 (16bit × 1)	—	—	2	1
ML610403P	1.25 to 3.6	32.768kHz (Crystal oscillation)	500kHz	2μs/30.5μs	0.9μA	-40 to +85	Mask	6K	—	192	4	4	18	2 (16bit × 1)	—	—	2	1
ML610404P	1.25 to 3.6	32.768kHz (Crystal oscillation)	2MHz	0.5μs/30.5μs	0.9μA	-40 to +85	Mask	8K	—	256	5	12	22	4 (16bit × 2)	—	16bit × 1	2	1
ML610405P	1.25 to 3.6	32.768kHz (Crystal oscillation)	2MHz	0.5μs/30.5μs	0.9μA	-40 to +85	Mask	8K	—	256	5	8	22	4 (16bit × 2)	—	16bit × 1	2	1
ML610406P	1.25 to 3.6	32.768kHz (Crystal oscillation)	2MHz	0.5μs/30.5μs	0.9μA	-40 to +85	Mask	8K	—	256	5	4	22	4 (16bit × 2)	—	16bit × 1	2	1
ML610407P	1.25 to 3.6	32.768kHz (Crystal oscillation)	2MHz	0.5μs/30.5μs	0.9μA	-40 to +85	Mask	16K	—	1K	5	12	22	4 (16bit × 2)	—	16bit × 1	2	1
ML610Q407P	1.25 to 3.6	32.768kHz (Crystal oscillation)	2MHz	0.5μs/30.5μs	0.9μA	-40 to +85	Flash	16K	—	1K	5	12	22	4 (16bit × 2)	—	16bit × 1	2	1
ML610Q407PA	1.25 to 3.6	32.768kHz (Crystal oscillation)	2MHz	0.5μs/30.5μs	0.9μA	-40 to +85	Flash	16K	—	1K	5	12	22	4 (16bit × 2)	—	16bit × 1	2	1
ML610408P	1.25 to 3.6	32.768kHz (Crystal oscillation)	2MHz	0.5μs/30.5μs	0.9μA	-40 to +85	Mask	16K	—	1K	5	8	22	4 (16bit × 2)	—	16bit × 1	2	1
ML610Q408P	1.25 to 3.6	32.768kHz (Crystal oscillation)	2MHz	0.5μs/30.5μs	0.9μA	-40 to +85	Flash	16K	—	1K	5	8	22	4 (16bit × 2)	—	16bit × 1	2	1
ML610409P	1.25 to 3.6	32.768kHz (Crystal oscillation)	2MHz	0.5μs/30.5μs	0.9μA	-40 to +85	Mask	16K	—	1K	5	4	22	4 (16bit × 2)	—	16bit × 1	2	1
ML610Q409P	1.25 to 3.6	32.768kHz (Crystal oscillation)	2MHz	0.5μs/30.5μs	0.9μA	-40 to +85	Flash	16K	—	1K	5	4	22	4 (16bit × 2)	—	16bit × 1	2	1
ML610Q411P	1.1 to 3.6	32.768kHz (Crystal oscillation)	500kHz	2μs/30.5μs	0.5μA	-40 to +85	Flash	16K	—	1K	6	3	22	4 (16bit × 2)	1	16bit × 1	2	1
ML610Q411PA	1.1 to 3.6	32.768kHz (Crystal oscillation)	500kHz	2μs/30.5μs	0.5μA	-40 to +85	Flash	16K	—	1K	6	3	22	4 (16bit × 2)	1	16bit × 1	2	1
ML610Q412P	1.1 to 3.6	32.768kHz (Crystal oscillation)	500kHz	2μs/30.5μs	0.5μA	-40 to +85	Flash	16K	—	1K	6	3	14	4 (16bit × 2)	1	16bit × 1	2	1

A check mark of halogen free support means that we will be able to ship out the halogen free products. For details, please inquire to the sales.

Built-in Speech Output Function MCU

8bit ML6103xx

Standard type 8bit Low Power MCU(Industrial Grade)

Part No.	Operating Conditions						ROM/RAM				Functions/Features				
	Operating Voltage (V)	Operating Frequency(Max.)		Minimum Instruction Execution Time	Current Consumption (Typ.@HALT)	Operating Temperature (°C)	ROM Type	ROM Capacity (Byte)	Data Flash Capacity (Byte)	Memory for Sound	RAM Capacity (Byte)	Port			
		Low Speed	High Speed									Input	Output	Input/Output	
ML610Q304	2.0 to 5.5	32.768kHz (Internal RC oscillation)		8.192MHz	0.122µs/30.5µs	2.7µA	-40 to +85	Flash	96K	2K	Flash ROM	1K	1	3	11
ML610Q359	2.2 to 3.6	32.768kHz (Crystal oscillation)		8.192MHz	0.122µs/30.5µs	1.7µA	-40 to +85	Flash	160K	3K	Flash ROM	2K	8	3	29
ML610Q360	2.2 to 3.6	32.768kHz (Crystal oscillation)		8.192MHz	0.122µs/30.5µs	1.7µA	-40 to +85	Flash P2ROM	160K	3K	P2ROM: 16M bit	2K	8	3	29

Built-in LCD Driver Segments type Low Power 8bit MCU

ML610Q380	2.2 to 5.5	32.768kHz (Internal RC oscillation/ Crystal oscillation)		8.192MHz	0.122µs/30.5µs	2.0µA	-40 to +70	Flash	128K	—	Flash ROM	2K	7	4	34
-----------	------------	--	--	----------	----------------	-------	------------	-------	------	---	-----------	----	---	---	----

A check mark of halogen free support means that we will be able to ship out the halogen free products. For details, please inquire to the sales.

Sensor Hub MCU

8bit ML61079x

U8 Core Based Standard type 8bit Low Power MCU

Part No.	Operating Conditions						ROM/RAM				Functions/Features			
	Operating Voltage (V)	Operating Frequency(Max.)		Minimum Instruction Execution Time	Current Consumption (Typ.@HALT)	Operating Temperature (°C)	ROM Type	ROM Capacity (Byte)	Data Flash Capacity (Byte)	RAM Capacity (Byte)	Port			
		Low Speed	High Speed								Input	Output	Input/Output	
ML610Q793*	V _{DD} : 1.7 to 1.9 AV _{DD} : 2.5 to 3.6	32.768kHz (External clock)		4.096MHz	0.25µs/30.5µs	0.6µA	-30 to +85	Flash	64K	—	4K	—	—	21
ML610Q794G*	2.5 to 3.6	32.768kHz (Crystal oscillation)		4.096MHz	0.25µs/30.5µs	1.1µA	-30 to +85	Flash	64K	—	4K	—	—	21

* : Not Recommended for New Design

A check mark of halogen free support means that we will be able to ship out the halogen free products. For details, please inquire to the sales.

32bit ML63079x

ARM Cortex-M0 Based Standard type 32bit Low Power MCU

Part No.	Operating Conditions						ROM/RAM				Functions/Features			
	Operating Voltage (V)	Operating Frequency(Max.)		Minimum Instruction Execution Time	Current Consumption (Typ.@SLEEPDEEP)	Operating Temperature (°C)	ROM Type	ROM Capacity (Byte)	Data Flash Capacity (Byte)	RAM Capacity (Byte)	Port			
		Low Speed	High Speed								Input	Output	Input/Output	
ML630Q791*	V _{DD} : 1.7 to 1.9	32.768kHz (External clock)		32MHz	—	2.5µA	-40 to +85	Flash	128K	—	16K	—	—	7

* : Not Recommended for New Design

(LAPIS Semiconductor products)

Functions/Features														Notes	Package	Chip Support	Halogen Free Support	Industrial Grade
8bit Timer	PWM	WDT	ADC (method)	Serial Port			Supply Voltage Detection	LCD Driver	External Interrupt Sources	SP Amp Output(W)/Class	Others							
				I ² C	SSIO	UART												
4 (16bit×2)	—	1	10bit×3 (SA type)	1	2	1	—	—	8	1.0(@5V) /D class	Speech function/ ADPCM decoder/ Built-in speaker amp.	—	P-VQFN28-0505-0.50	—	✓	✓		
8 (16bit×4)	—	1	12bit×4 (SA type)	—	2	2	VLS×1	—	7	0.5(@3V) /AB class	Speech function/ ADPCM decoder/ Built-in speaker amp.	—	P-TQFP64-1010-0.50	—	✓	✓		
8 (16bit×4)	—	1	12bit×4 (SA type)	—	2	2	VLS×1	—	7	0.5(@3V) /AB class	Speech function/ ADPCM decoder/ Built-in speaker amp.	—	P-TQFP64-1010-0.50	—	—	✓		
6 (16bit×3)	16bit×2	1	10bit×8 (SA type)	1	2	2	BLD×1	Max. 96dot 24seg. ×4com.	5	0.6(@5V) /AB class	Speech function/ ADPCM decoder/ Built-in speaker amp.	—	P-QFP80-1414-0.65	—	—	—		

(LAPIS Semiconductor products)

Functions/Features										Notes	Package	Chip Support	Halogen Free Support	Industrial Grade
8bit Timer	PWM	WDT	ADC (method)	Serial Port				External Interrupt Sources	Others					
				I ² C	SSIO	UART	I ² C/SPI(for Host Communication)							
6 (16bit×3)	—	1	12bit×3 (SA type)	1	1	2	1	16	16bit Square Root, Multiply, Divider, Host I/F(SPI/I ² C/Logging RAM : 8KB)	—	S-UFLGA48-3.06×2.96-0.40 (WCSP48)	—	✓	—
6 (16bit×3)	—	1	12bit×2 (SA type)	1	1	2	1	16	16bit Square Root, Multiply, Divider, Host I/F(SPI/I ² C/Logging RAM : 8KB)	—	P-TQFP48-0707-0.50	—	✓	—

(LAPIS Semiconductor products)

Functions/Features										Notes	Package	Chip Support	Halogen Free Support	Industrial Grade
8bit Timer	PWM	WDT	ADC (method)	Serial Port				External Interrupt Sources	Others					
				I ² C	SSIO	UART	I ² C/SPI(for Host Communication)							
8 (16bit×4)	1	1	—	2	—	1	1	7	Square Root, Division operations, Host I/F(Built-in 512 byte communication register)	—	(WCSP)	—	✓	—

A
 Microcontroller



IC Packages

CONTENTS

ROHM Packages

Part No. Explanation	P. A124
Package Ordering Units	P. A125
QFP Packages	P. A126
VMMP Package	P. A128
SON Packages	P. A129
QFN Packages	P. A130
SOP Packages	P. A132
HSOP Packages	P. A134
Small Packages	P. A136
Non-Lead Packages	P. A136
Power Packages	P. A137
BGA Packages	P. A139
WL-CSP Packages	P. A141

LAPIS Semiconductor Packages

Package List	P. A142
Part No. Explanation	P. A142
SOP Packages	P. A143
QFP Packages	P. A146
DIP Package	P. A148
QFN Packages	P. A149
WSON Package	P. A150
BGA Packages	P. A151
LGA Package	P. A152
WL-CSP Package	P. A152

*Please check the dimensions of each products in detail.

LAPIS Semiconductor products and ROHM Semiconductor dimensions products have different although they have a same package name.

Please refer packages from page, A142 for LAPIS Semiconductor products.

Part No. Explanation

- When ordering, specify the part number.
- Check each code against the tables shown below.
- Fill in from the left, leaving any extra boxes empty on the right.

B **A** **4** **5** **5** **8** **F** **-** **D** **X** **E** **2**

Part No.

Custom Specification code

Packaging and forming specification

Alphabetical symbols specify custom product. Standard product has no symbols.

E2	Embossed tape and reel	Pin 1 fed last
(E1)	Embossed tape and reel	Pin 1 fed first
TR	Embossed tape and reel	Pin 1 fed last
(TL)	Embossed tape and reel	Pin 1 fed first

Ordering information

1. A packaging specification is not required for packaging other than taping.
(Ex.) BA4558F or BA4558F-DX
2. A packaging specification is required for tape packaging.
(Ex.) Example of E2-oriented embossed taping: BA4558F-E2 or BA4558F-DXE2

For example

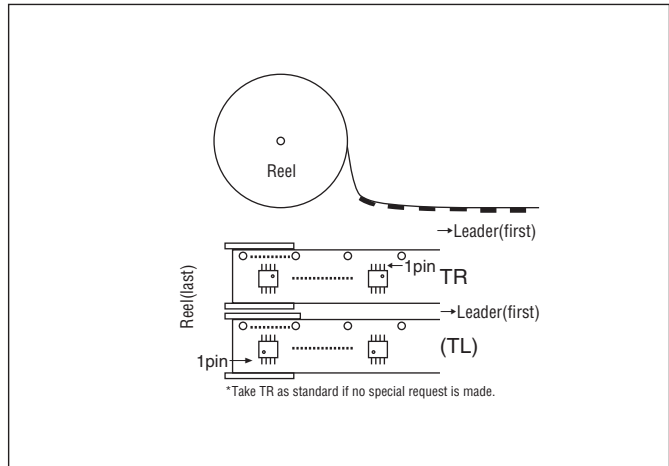
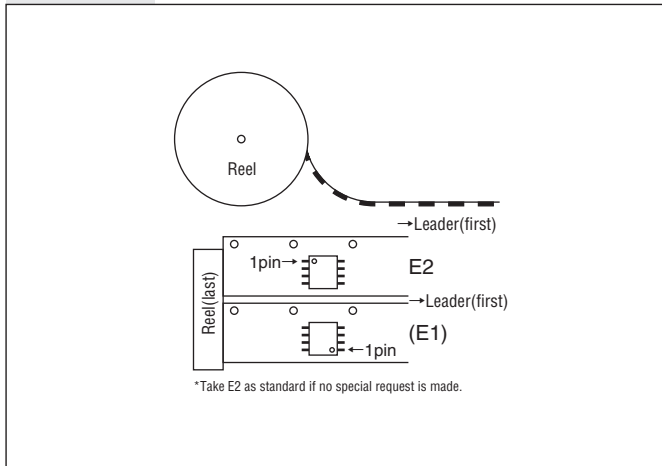

Please refer packages from page, A142 for LAPIS Semiconductor products.

Package Ordering Units

● Embossed tape packaging <Package specification name : E2(E1)>

Package ordering unit quantity	Non-Lead Gull Wing Packages	SOP Packages	Power Packages	QFP Packages	BGA/QFN
5,000	SSON004X1216*, SSON004X1010	—	—	—	—
4,000	USON016X3315, WSON008X2120, VSON008X2020, VSON008X2030, VSON010X3020, VSON010X3030, USON014X3020, VQFN016X3030, VMMP008Z1830*	—	—	—	—
3,000	VSO5*, HVSOF5/6*, HSON8*, WSOF5/6/6I*, VSON008V2030*, VSON010V3030, VQFN016V3030, WL-CSP (2.8mm [□] and under)	TSSOP-B8, SOP4*, SSOP3/5/6*, MSOP8/10*	—	—	3×3mm
2,500	VQFN020V4040, VQFN024V4040, VQFN028V5050, VQFN032V5050, UQFN036V5050, UQFN040V5050, WL-CSP (over 2.81mm [□])	SOP8/14/16, SSOP-A16, TSSOP-C10J, TSSOP-B14J, SSOP-B8/14/16/20, SOP-J8/J14, HTSSOP-B8J/16/20/28, HTSOP-J8, TSSOP-B8J, TSSOP-C30	—	—	4×4mm, 5×5mm, 6×6mm
2,000	VQFN040V6060, UQFN044V6060, UQFN046V4565, UQFN048V6060	SOP18/20/22/24, SSOP-A20/24/32, SSOP-B24/28/40, HTSSOP-C48, HTSSOP-B24/30/40, HSOP25, TSSOP-C44	HRP5/7*, TO252-3/5, SOT223-4, TO263-7, TO252-J3/J5	—	6×6mm
1,500	VQFN048V7070, UQFN048V7070, UQFN056V7070	SOP28, SSOP-A44, HTSSOP-A44/A44R/B54, HSOP28/-M28/-M36	—	QFP32, TQFP48V, VQFP48C, HTQFP48V, UQFP64, TQFP64U	7×7mm
1,000	VQFN56SAV080, UQFN064V8080, UQFN068V8080, UQFN088V0100	HSSOP-A54	—	SQFP-T52, QFP44, VQFP64, VQFP80, UQFP80, TQFP64V, HTQFP64AV, HTQFP64BV	8×8mm, 9×9mm, 10×10mm
500	—	—	TO220FP-3/-5, TO263-3/5	VQFP100, TQFP100V	—

1) *:Package specification : TR(TL)

2) Specification differ by package size of WL-CSP

3) WL-CSP Package Specification : E2 (standard)

● Tray packaging

Pin pitch: 0.8 mm	Pin pitch: 0.65 mm	Pin pitch: 0.5 mm	Pin pitch: 0.4 mm	Dimensions d×e(mm)	Individual package quantity	Tray quantity	Package ordering unit quantity	Tomson Case dimensions A×B×C(mm)
QFP32	—	VQFP48C	—	175×166	100	10	1,000	60×200×200
QFP44	SQFP-T52/64	VQFP64/80, HTQFP64AV, HTQFP64BV, TQFP48V/64V/80V	UQFP64/80, TQFP64U	216×116	50	20	1,000	70×130×510
—	—	VQFP144/-T144	—	322.6×135.9	60	10	600	75×140×338
QFP-A64, QFP80/T80	—	VQFP100, TQFP100V, HTQFP100V	UQFP120, TQFP128U	256×166	50	10	500	75×200×290
—	—	VQFP176	—	322.6×135.9	40	10	400	75×140×338
QFP120	SQFP160C	VQFP208	—	322.6×135.9	24	10	240	75×140×338

A

IC Packages

Please refer packages from page, A142 for LAPIS Semiconductor products.

QFP Packages

(Unit: mm)

QFP <Pin Pitch:0.8mm>

QFP32

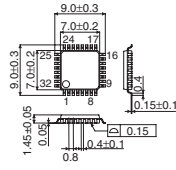

Tray:1,000pcs
 Embossed carrier tape:1,500pcs

QFP44

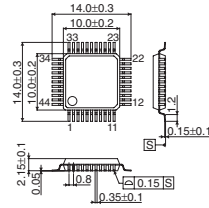

Tray:1,000pcs
 Embossed carrier tape:1,000pcs

SQFP <Pin Pitch:0.65mm>

SQFP-T52

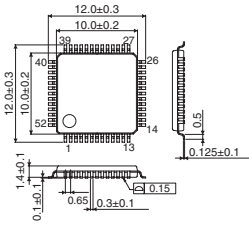

Tray:1,000pcs
 Embossed carrier tape:1,000pcs

SQFP-T64

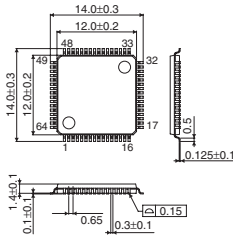

Tray:1,000pcs

SQFP160C

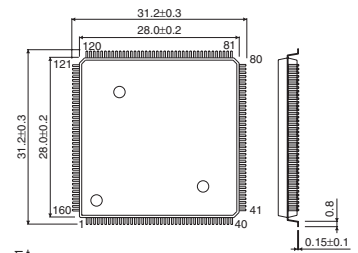

Tray:240pcs

A

TQFPV <Pin Pitch:0.5mm>

TQFP48V

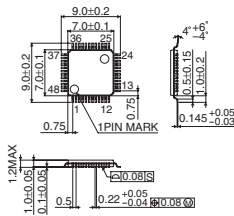

Tray:1,000pcs
 Embossed carrier tape:1,500pcs

TQFP64V

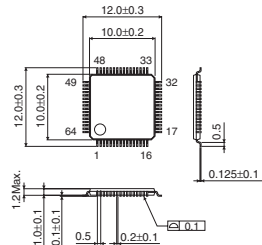

Tray:1,000pcs
 Embossed carrier tape:1,000pcs

TQFP80V

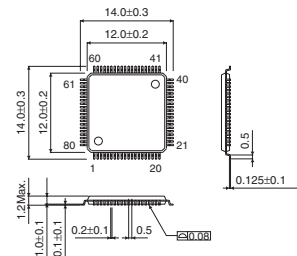

Tray:1,000pcs

TQFP100V

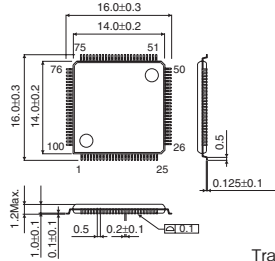

Tray:500pcs
 Embossed carrier tape:500pcs

Please refer packages from page, A142 for LAPIS Semiconductor products.

QFP Packages

(Unit: mm)

VQFP <Pin Pitch:0.5mm>

VQFP48C

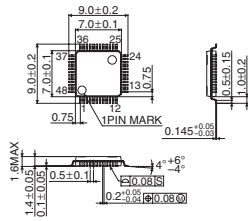

Tray:1,000pcs
 Embossed carrier tape:1,500pcs

VQFP64

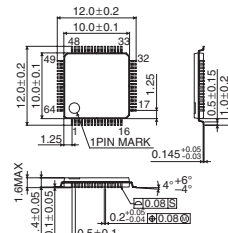

Tray:1,000pcs
 Embossed carrier tape:1,000pcs

VQFP80

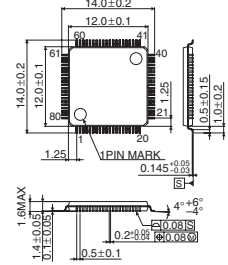

Tray:1,000pcs
 Embossed carrier tape:1,000pcs

VQFP100

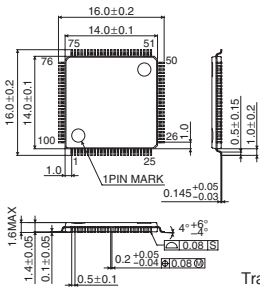

Tray:500pcs
 Embossed carrier tape:500pcs

VQFP144

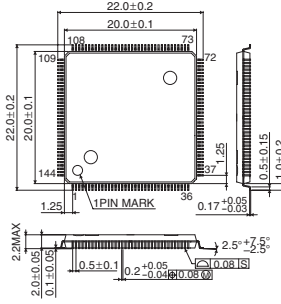

Tray:600pcs

VQFP-T144

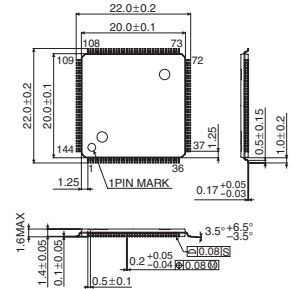

Tray:600pcs

VQFP176

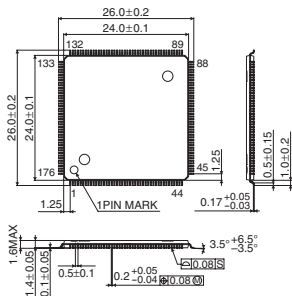

Tray:400pcs

VQFP208

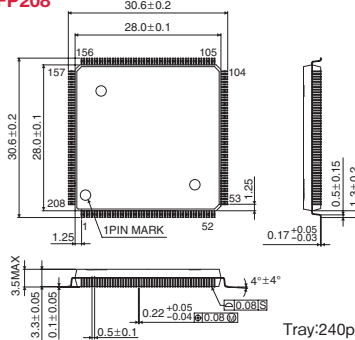

Tray:240pcs

Please refer packages from page, A142 for LAPIS Semiconductor products.

QFP Packages

(Unit: mm)

UQFP <Pin Pitch:0.4mm>

UQFP64

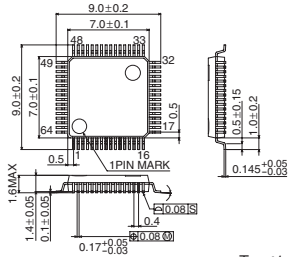

Tray:1,000pcs
 Embossed carrier tape:1,500pcs

UQFP80

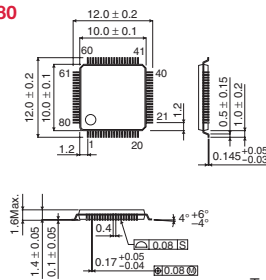

Tray:1,000pcs
 Embossed carrier tape:1,000pcs

UQFP120

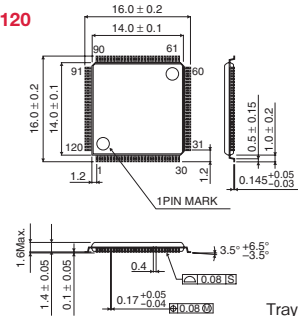

Tray:500pcs

TQFPU <Pin Pitch:0.4mm>

TQFP64U

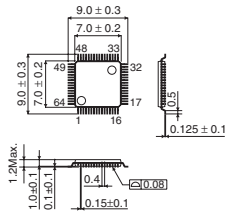

Tray:1,000pcs
 Embossed carrier tape:1,500pcs

TQFP128U

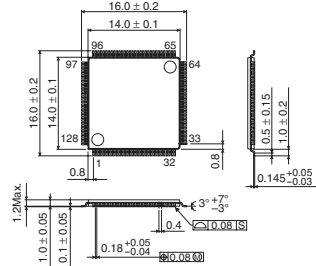

Tray:500pcs

HTQFPV <Pin Pitch:0.5mm>

HTQFP48V

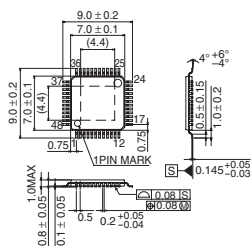

Tray:1,000pcs
 Embossed carrier tape:1,500pcs

HTQFP64AV

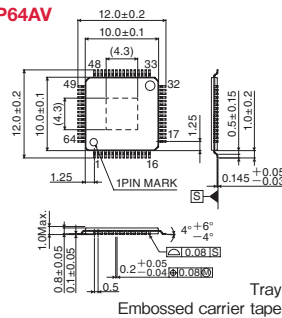

Tray:1,000pcs
 Embossed carrier tape:1,000pcs

HTQFP64BV

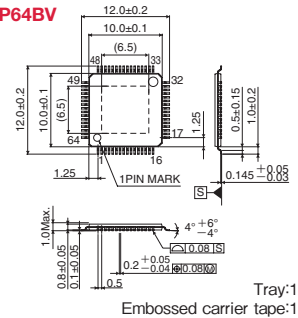

Tray:1,000pcs
 Embossed carrier tape:1,000pcs

HTQFP100V

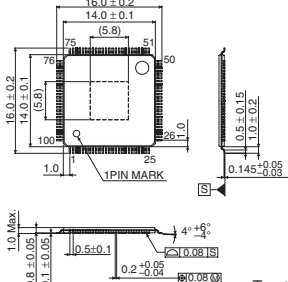

Tray:500pcs

VMMP Package

(Unit: mm)

VMMP <Pin Pitch:0.5mm>

VMMP008Z1830

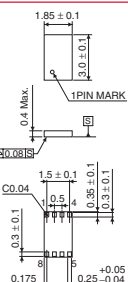

Embossed carrier tape:4,000pcs

Please refer packages from page, A142 for LAPIS Semiconductor products.

SON Packages (Unit: mm)

SSON-X <Pin Pitch:0.65mm>

SSON004X1010

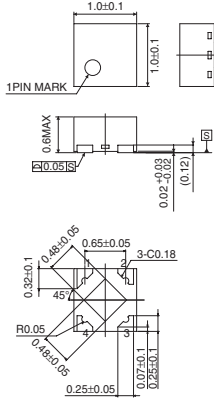

Embossed carrier tape:5,000pcs

SSON004X1216

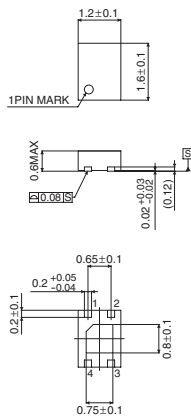

Embossed carrier tape:5,000pcs

VSON-V <Pin Pitch:0.5mm>

VSON008V2030

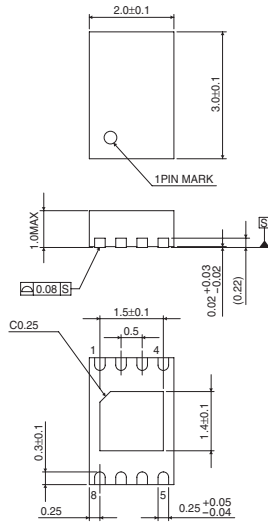

Embossed carrier tape:3,000pcs

VSON010V3030

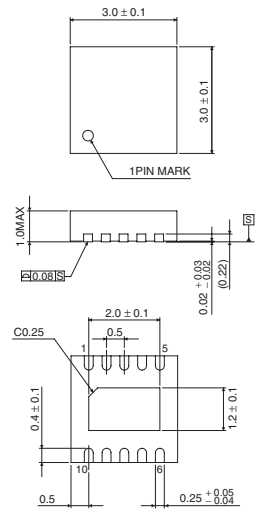

Embossed carrier tape:3,000pcs

VSON-X <Pin Pitch:0.5mm> / USON-X <Pin Pitch:0.4mm>

VSON008X2020

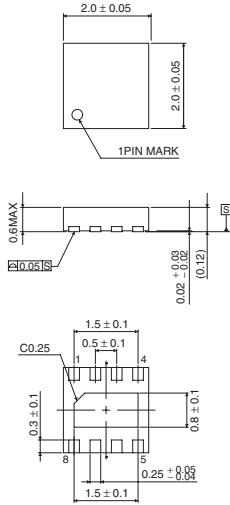

Embossed carrier tape:4,000pcs

VSON008X2030

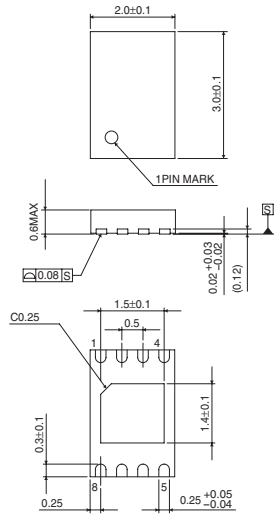

Embossed carrier tape:4,000pcs

VSON010X3020

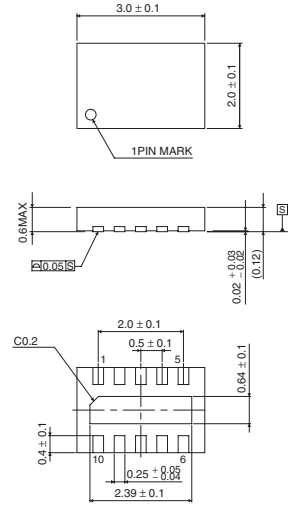

Embossed carrier tape:4,000pcs

VSON010X3030

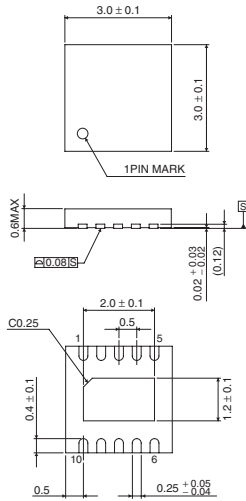

Embossed carrier tape:4,000pcs

USON014X3020

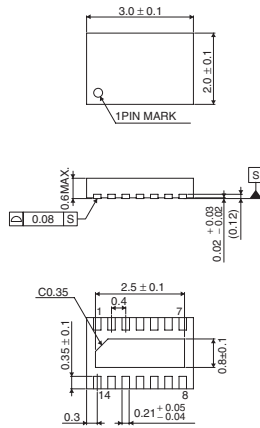

Embossed carrier tape:4,000pcs

USON016X3315

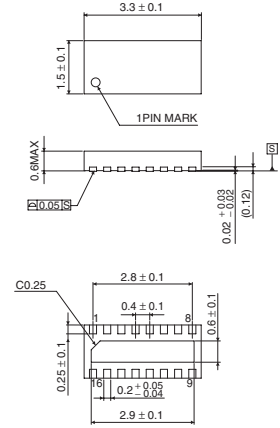

Embossed carrier tape:4,000pcs

A
IC Packages

Please refer packages from page, A142 for LAPIS Semiconductor products.

QFN Packages

(Unit: mm)

QFN028 <Pin Pitch:0.4mm>

QFN028 (Powervation Series)

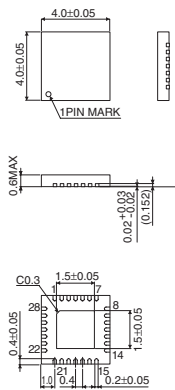

Tape:250, 500, 1,000, 5,000pcs

QFN032 <Pin Pitch:0.5mm>

QFN032 (Powervation Series)

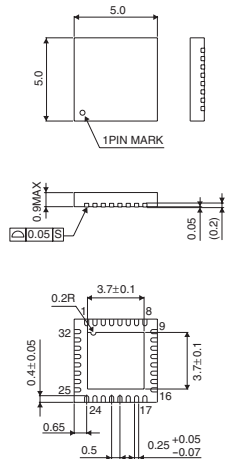

Tape:250, 500, 1,000, 5,000pcs

VQFN-X <Pin Pitch:0.5mm>

VQFN016X3030

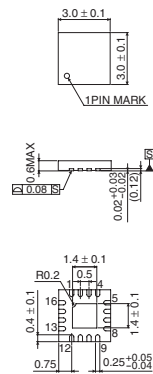

Embossed carrier tape:4,000pcs

VQFN-V <Pin Pitch:0.5mm>

VQFN016V3030

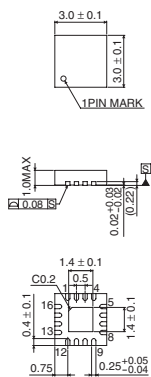

Embossed carrier tape:3,000pcs

VQFN020V4040

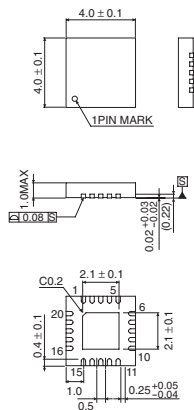

Embossed carrier tape:2,500pcs

VQFN024V4040

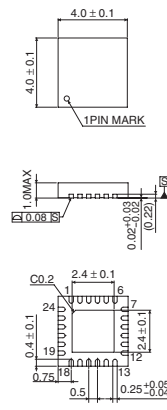

Embossed carrier tape:2,500pcs

VQFN028V5050

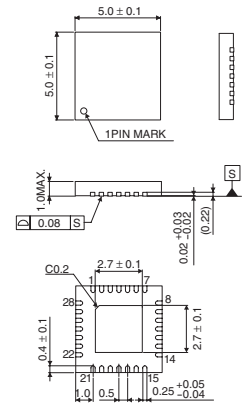

Embossed carrier tape:2,500pcs

VQFN032V5050

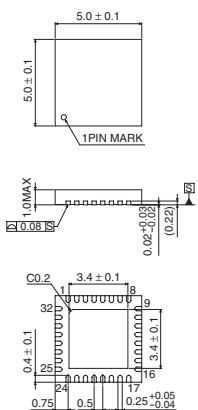

Embossed carrier tape:2,500pcs

VQFN040V6060

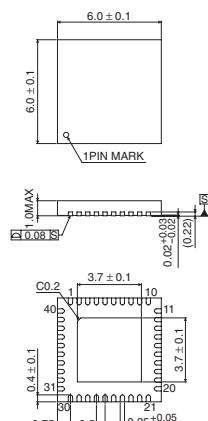

Embossed carrier tape:2,000pcs

VQFN048V7070

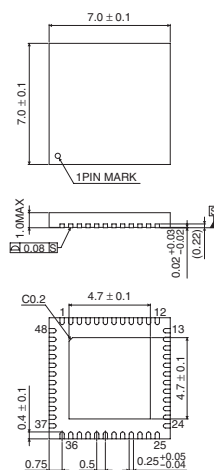

Embossed carrier tape:1,500pcs

VQFN56SAV080

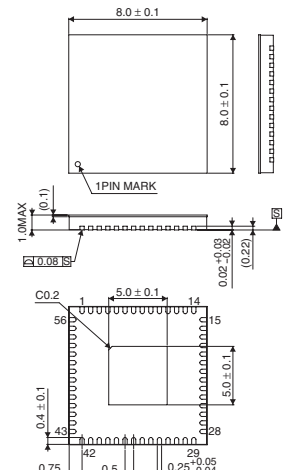

Under Development
Embossed carrier tape:1,000pcs

Please refer packages from page, A142 for LAPIS Semiconductor products.

QFN Packages

(Unit: mm)

UQFN-V <Pin Pitch:0.4mm>

UQFN036V5050

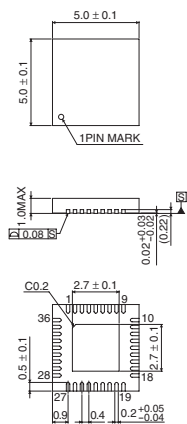

Embossed carrier tape:2,500pcs

UQFN040V5050

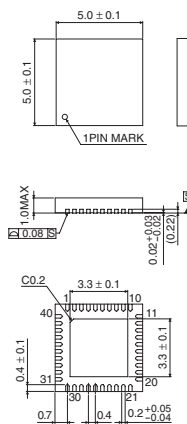

Embossed carrier tape:2,500pcs

UQFN044V6060

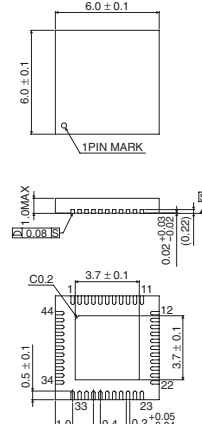

Embossed carrier tape:2,000pcs

UQFN048V6060

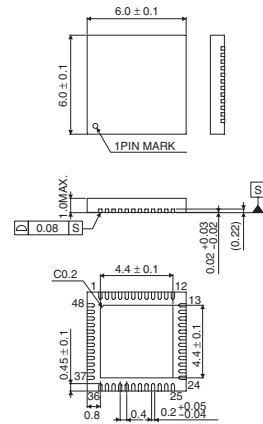

Embossed carrier tape:2,000pcs

UQFN046V4565

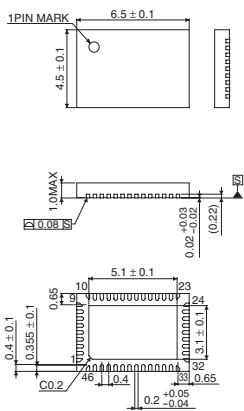

Embossed carrier tape:2,000pcs

UQFN048V7070

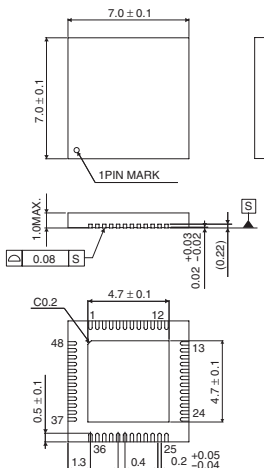

Embossed carrier tape:1,500pcs

UQFN056V7070

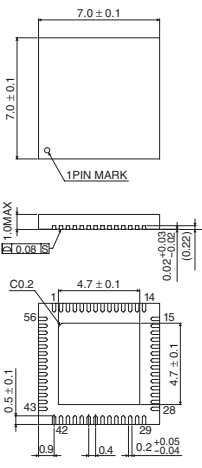

Embossed carrier tape:1,500pcs

UQFN064V8080

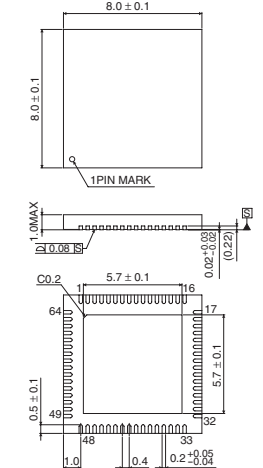

Embossed carrier tape:1,000pcs

UQFN068V8080

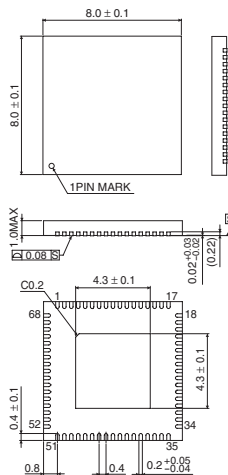

Embossed carrier tape:1,000pcs

UQFN88MV0100

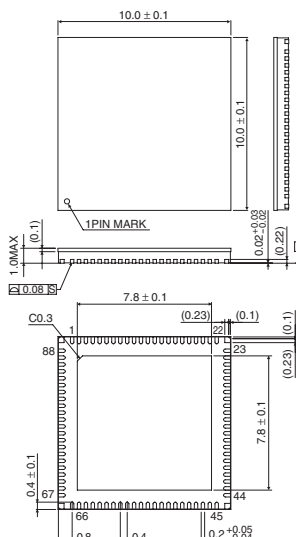

Under Development
Embossed carrier tape:1,000pcs

A

IC Packages

Please refer packages from page, A142 for LAPIS Semiconductor products.

SOP Packages

(Unit: mm)

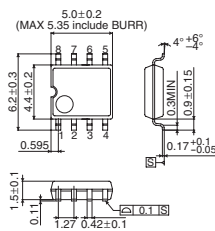
SOP <Pin Pitch:1.27mm>
SOP8

Embossed carrier tape:2,500pcs

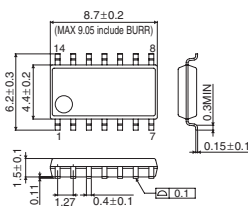
SOP14

Embossed carrier tape:2,500pcs

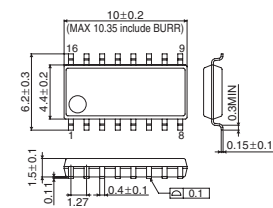
SOP16

Embossed carrier tape:2,500pcs

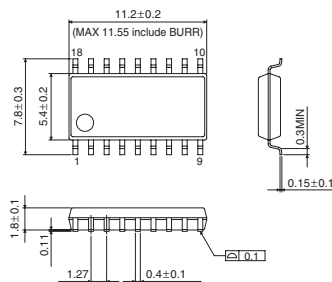
SOP18

Embossed carrier tape:2,000pcs

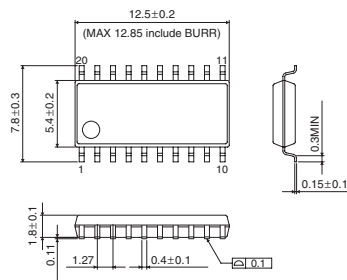
SOP20

Embossed carrier tape:2,000pcs

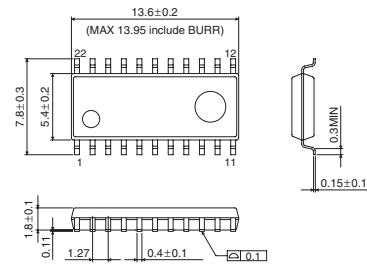
SOP22

Embossed carrier tape:2,000pcs

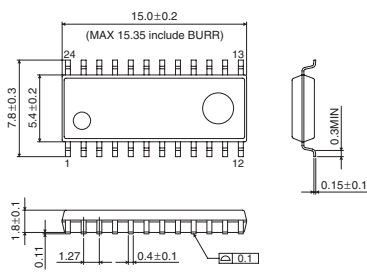
SOP24

Embossed carrier tape:2,000pcs

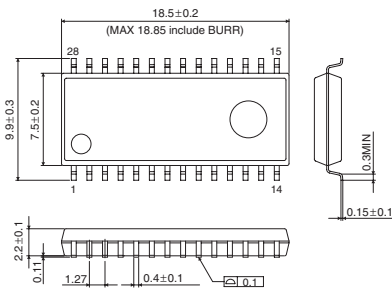
SOP28

Embossed carrier tape:1,500pcs

A

IC Packages

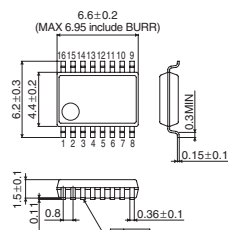
SSOP-A <Pin Pitch:0.8mm>
SSOP-A16

Embossed carrier tape:2,500pcs

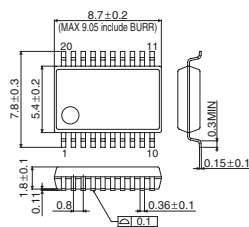
SSOP-A20

Embossed carrier tape:2,000pcs

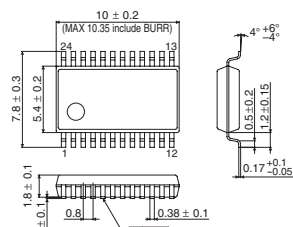
SSOP-A24

Embossed carrier tape:2,000pcs

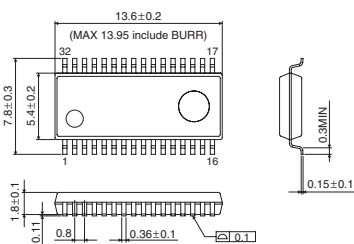
SSOP-A32

Embossed carrier tape:2,000pcs

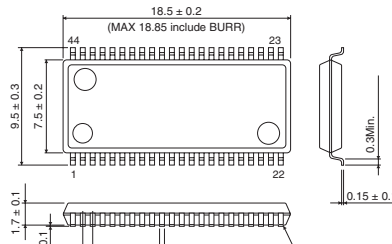
SSOP-A44

Embossed carrier tape:1,500pcs

Please refer packages from page, A142 for LAPIS Semiconductor products.

SOP Packages

(Unit: mm)

SSOP-B <Pin Pitch:0.65mm>

SSOP-B8

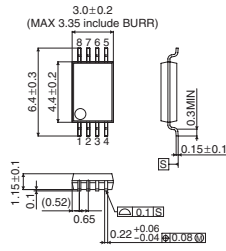

Embossed carrier tape:2,500pcs

SSOP-B14

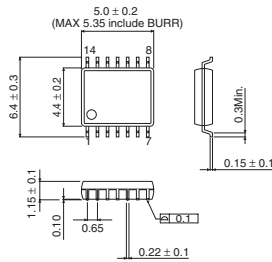

Embossed carrier tape:2,500pcs

SSOP-B16

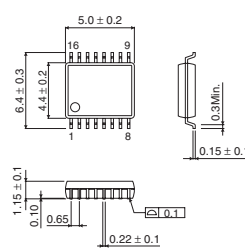

Embossed carrier tape:2,500pcs

SSOP-B20

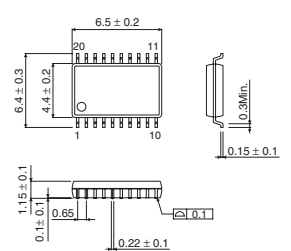

Embossed carrier tape:2,500pcs

SSOP-B24

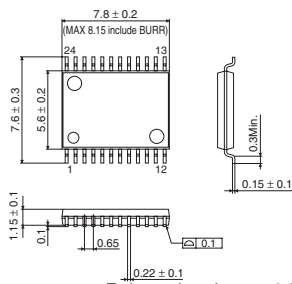

Embossed carrier tape:2,000pcs

SSOP-B28

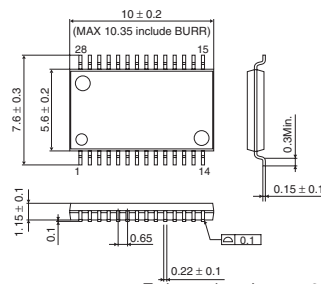

Embossed carrier tape:2,000pcs

SSOP-B40

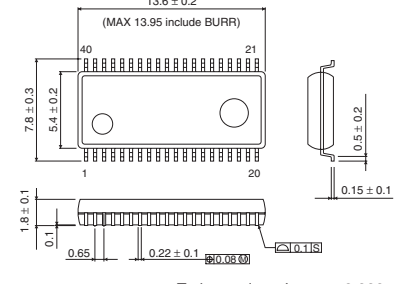

Embossed carrier tape:2,000pcs

JEDEC <Pin Pitch:1.27mm/0.65mm/0.5mm>

SOP-J8

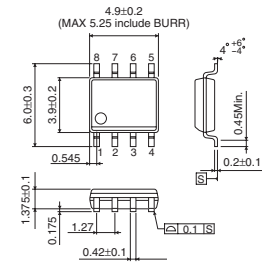

Embossed carrier tape:2,500pcs

SOP-J14

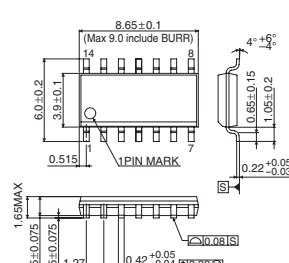

Embossed carrier tape:2,500pcs

TSSOP-B8

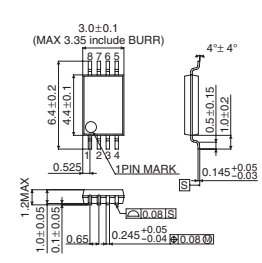

Embossed carrier tape:3,000pcs

TSSOP-B8J

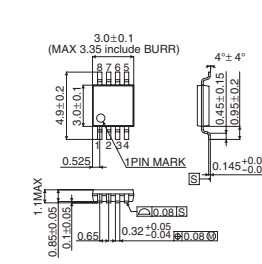

Embossed carrier tape:2,500pcs

TSSOP-C10J

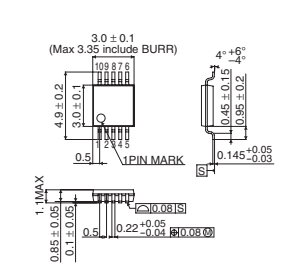

Embossed carrier tape:2,500pcs

TSSOP-B14J

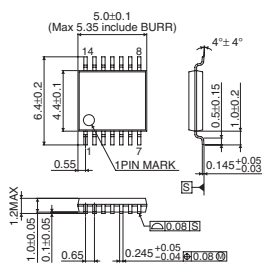

Embossed carrier tape:2,500pcs

TSSOP-C30

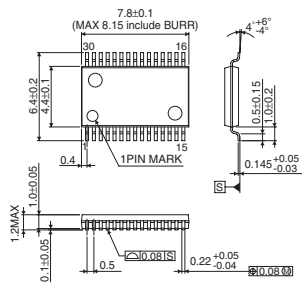

Embossed carrier tape:2,500pcs

TSSOP-C44

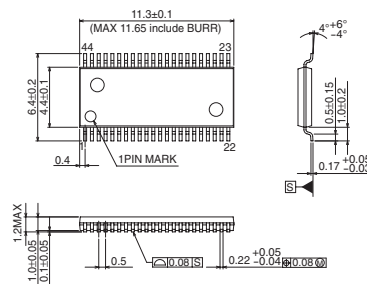

Embossed carrier tape:2,000pcs

A

IC Packages

Please refer packages from page, A142 for LAPIS Semiconductor products.

HSOP Packages

(Unit: mm)

HSOP <Pin Pitch:0.8mm>

HSOP25

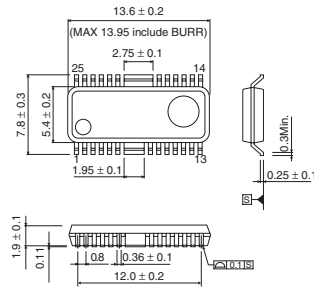

Embossed carrier tape: 2,000 pcs

HSOP28

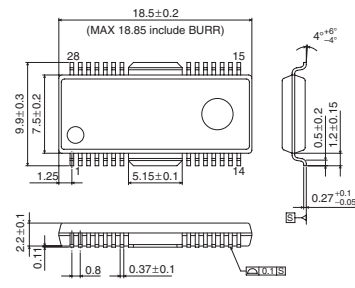

Embossed carrier tape: 1,500 pcs

HSOP-M28

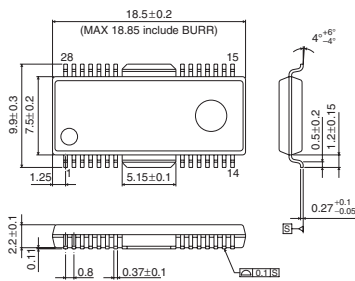

Embossed carrier tape: 1,500 pcs

HSOP-M36

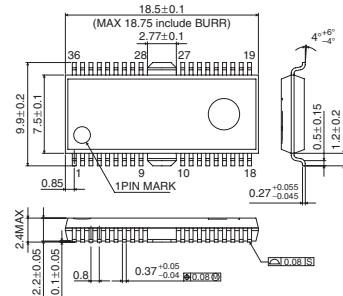

Embossed carrier tape: 1,500 pcs

HTSOP-J <Pin Pitch:1.27mm>

HTSOP-J8

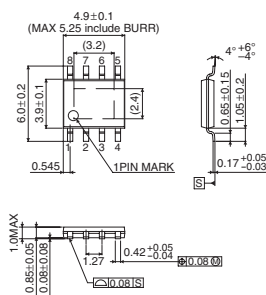

Embossed carrier tape: 2,500 pcs

HTSSOP-C <Pin Pitch:0.5mm>

HTSSOP-C48

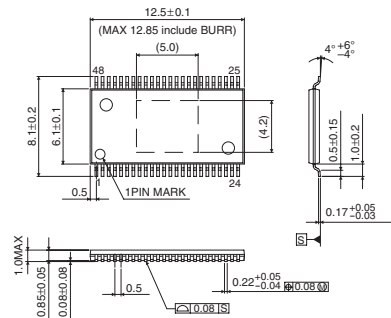

Embossed carrier tape: 2,000 pcs

HTSSOP-A <Pin Pitch:0.8mm>

HTSSOP-A44

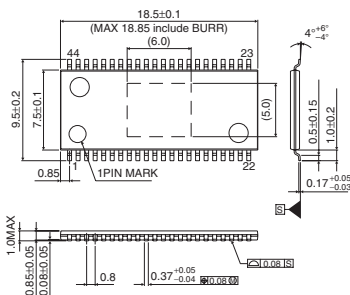

Embossed carrier tape: 1,500 pcs

HTSSOP-A44R

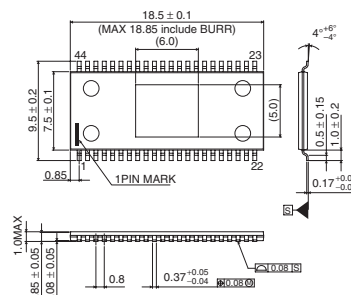

Embossed carrier tape: 1,500 pcs

HTSSOP-A54

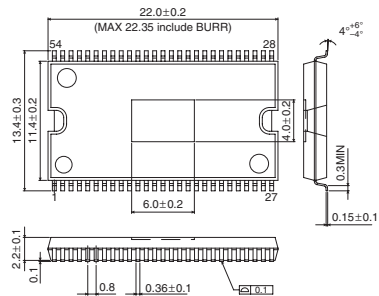

Embossed carrier tape: 1,000 pcs

Please refer packages from page, A142 for LAPIS Semiconductor products.

HSOP Packages

(Unit: mm)

HTSSOP-B <Pin Pitch:0.65mm>

HTSSOP-B8J

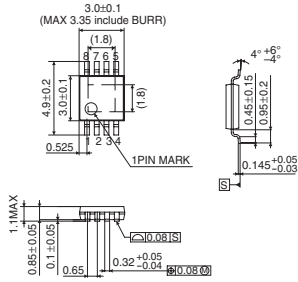

Embossed carrier tape:2,500pcs

HTSSOP-B16

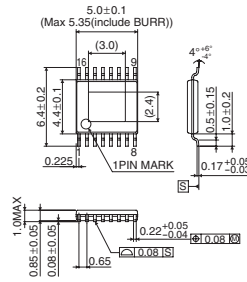

Embossed carrier tape:2,500pcs

HTSSOP-B20

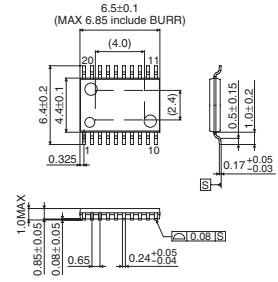

Embossed carrier tape:2,500pcs

HTSSOP-B24

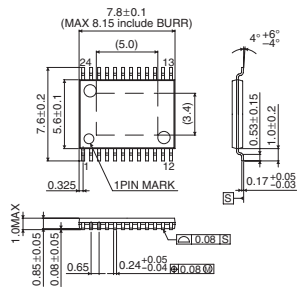

Embossed carrier tape:2,000pcs

HTSSOP-B28

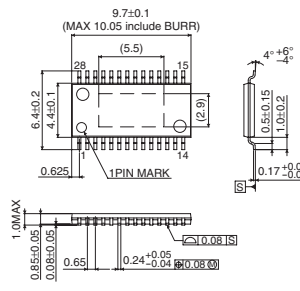

Embossed carrier tape:2,500pcs

HTSSOP-B30

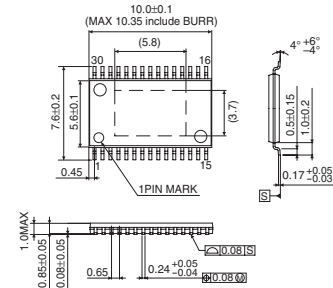

Embossed carrier tape:2,000pcs

HTSSOP-B40

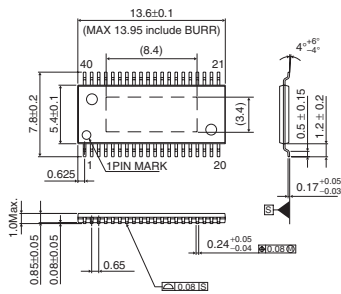

Embossed carrier tape:2,000pcs

HTSSOP-B54

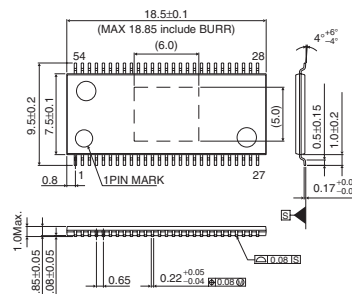

Embossed carrier tape:1,500pcs

Please refer packages from page, A142 for LAPIS Semiconductor products.

Small Packages

(Unit: mm)

SOP Type

SOP4

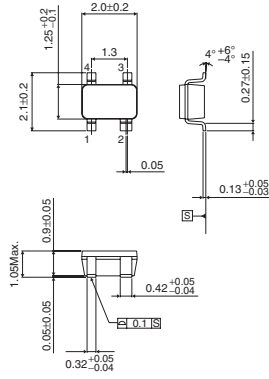

Embossed carrier tape:3,000pcs

SSOP3

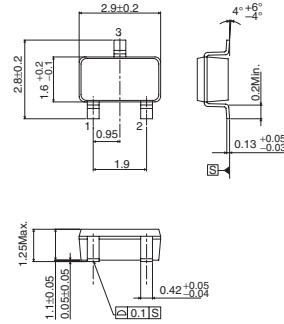

Embossed carrier tape:3,000pcs

SSOP5

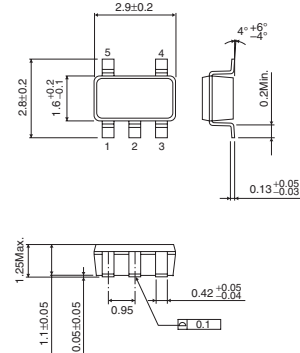

Embossed carrier tape:3,000pcs

SSOP6

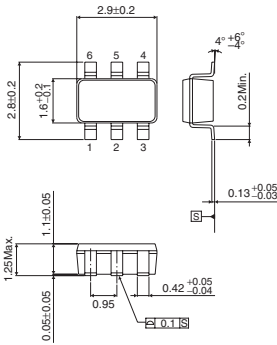

Embossed carrier tape:3,000pcs

MSOP8

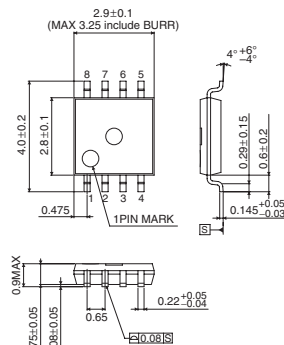

Embossed carrier tape:3,000pcs

MSOP10

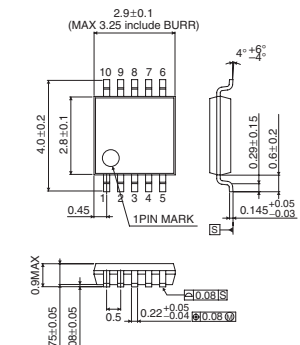

Embossed carrier tape:3,000pcs

Non-Lead Packages

(Unit: mm)

Non-Lead

VSO5

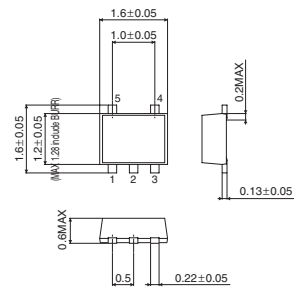

Embossed carrier tape:3,000pcs

HVSO5

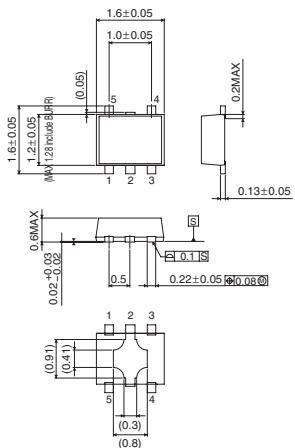

Embossed carrier tape:3,000pcs

HVSO6

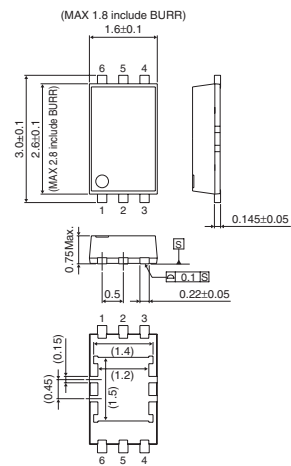

Embossed carrier tape:3,000pcs

HSO8

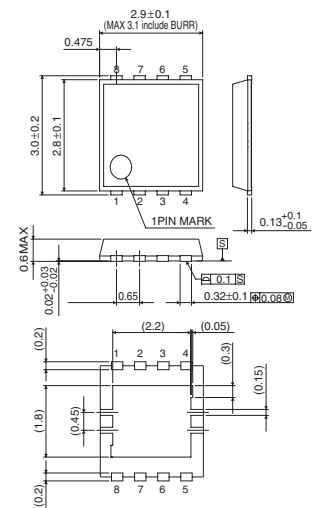

Embossed carrier tape:3,000pcs

Please refer packages from page, A142 for LAPIS Semiconductor products.

Non-Lead Packages

(Unit: mm)

Optical Non-Lead

WSOF5(Clear Type)

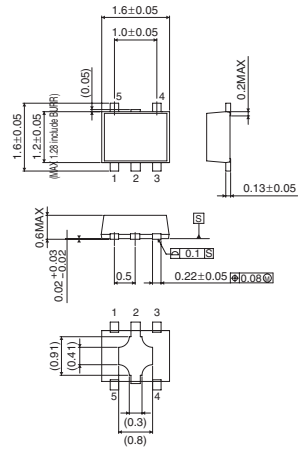

Embossed carrier tape:3,000pcs

WSOF6 (Clear Type)

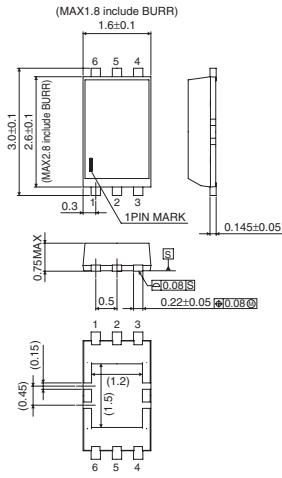

Embossed carrier tape:3,000pcs

WSOF6I

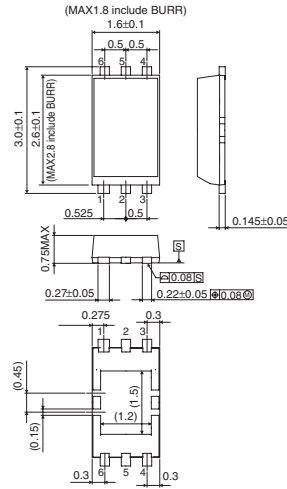

Embossed carrier tape:3,000pcs

WSON008X2120 (Clear Type)

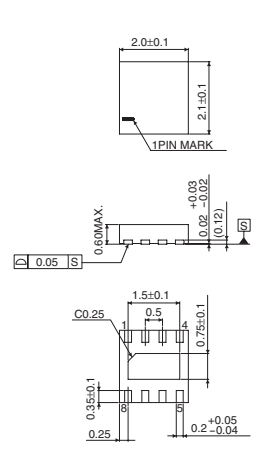

Embossed carrier tape:4,000pcs

Power Packages

(Unit: mm)

POWER-3PIN

TO220CP-3

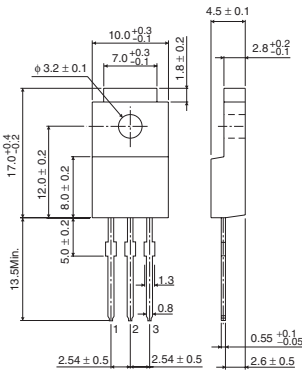

Embossed carrier tape:500pcs

TO252-3

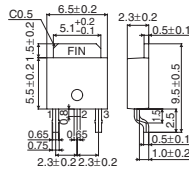

Embossed carrier tape:2,000pcs

TO252-J3

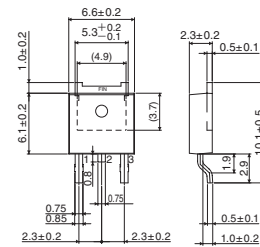

Embossed carrier tape:2,000pcs

TO263-3

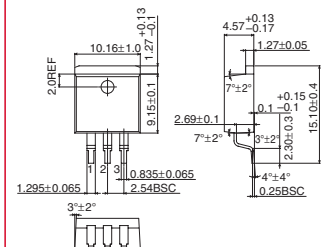

Embossed carrier tape:500pcs

POWER-4PIN

SOT223-4

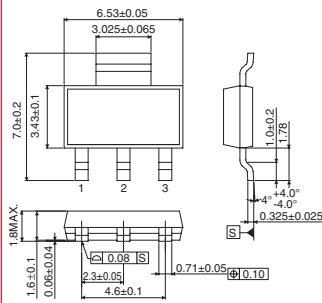

Embossed carrier tape:2,000pcs

A

IC Packages

Please refer packages from page, A142 for LAPIS Semiconductor products.

Power Packages

(Unit: mm)

POWER-5PIN

TO220FP-5

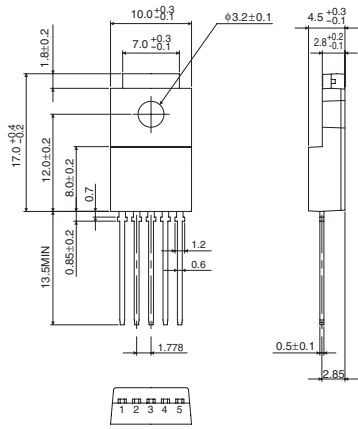

Container tube:500pcs

TO252-5

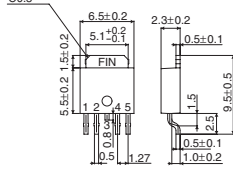

Embossed carrier tape:2,000pcs

HRP5

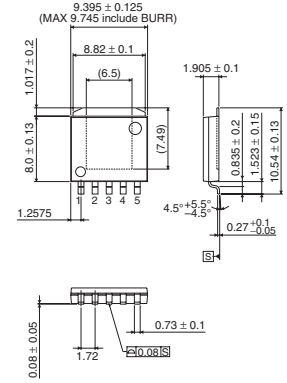

Embossed carrier tape:2,000pcs

TO263-5

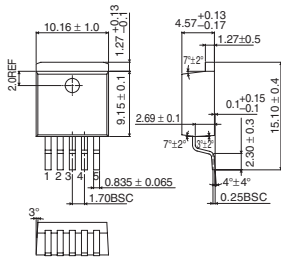

Embossed carrier tape:500pcs

TO252-J5

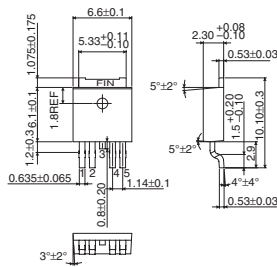

Embossed carrier tape:2,000pcs

A

IC Packages

POWER-7PIN

HRP7

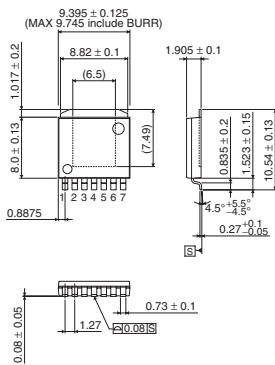

Embossed carrier tape:2,000pcs

TO263-7

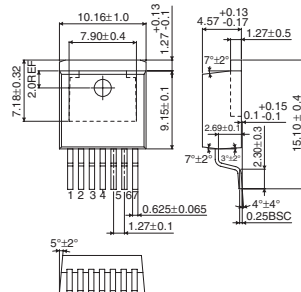

Embossed carrier tape:2,000pcs

Please refer packages from page, A142 for LAPIS Semiconductor products.

BGA Packages

(Unit: mm)

VBGA-T <Pin Pitch:0.5mm>

VBGA035T040

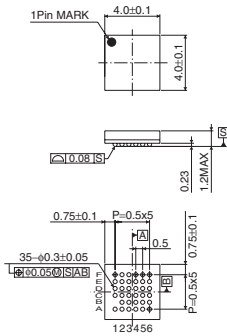

Embossed carrier tape:2,500pcs

VBGA048T050

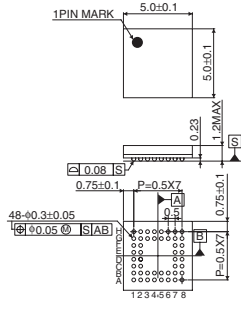

Embossed carrier tape:2,500pcs

VBGA063T050

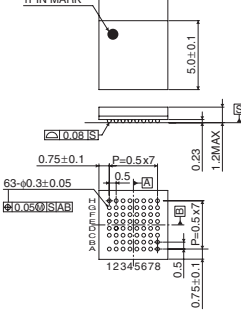

Embossed carrier tape:2,500pcs

VBGA099T060

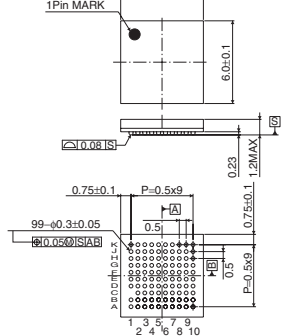

Embossed carrier tape:2,000pcs

VBGA120T060

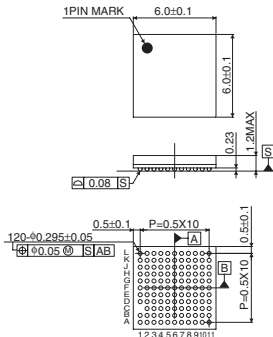

Embossed carrier tape:2,000pcs

VBGA131T070

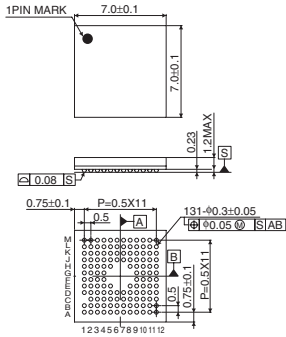

Embossed carrier tape:1,500pcs

VBGA143T070

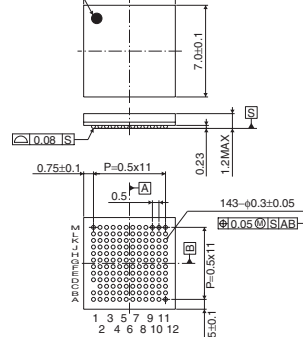

Embossed carrier tape:1,500pcs

VBGA161T080

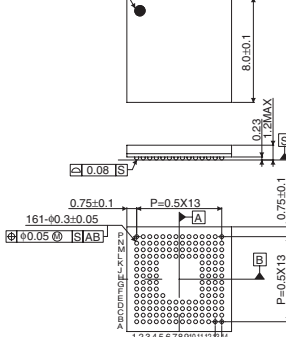

Embossed carrier tape:1,000pcs

VBGA195T080

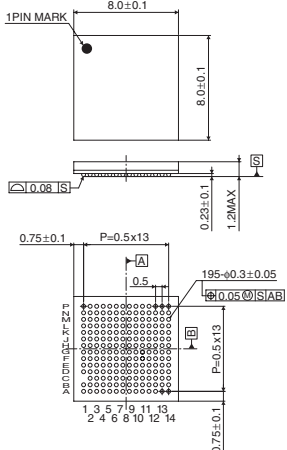

Embossed carrier tape:1,000pcs

VBGA256T100

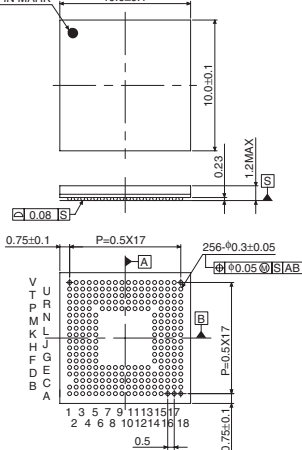

Embossed carrier tape:1,000pcs

VBGA-B <Pin Pitch:0.5mm>

VBGA145B070

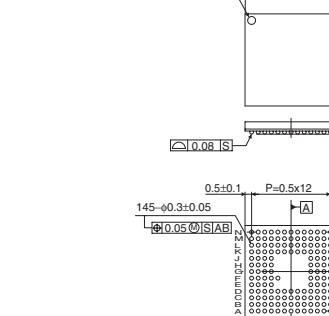

Embossed carrier tape:1,500pcs

UBGA-W <Pin Pitch:0.4mm>

UBGA035W030

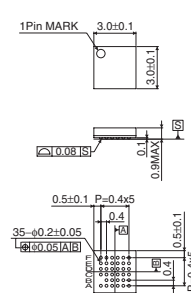

Embossed carrier tape:3,000pcs

Please refer packages from page, A142 for LAPIS Semiconductor products.

BGA Packages

(Unit: mm)

VBGA-W <Pin Pitch:0.5mm>

VBGA035W040

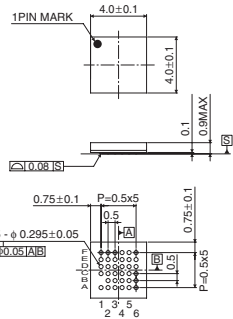

Embossed carrier tape:2,500pcs

VBGA048W040

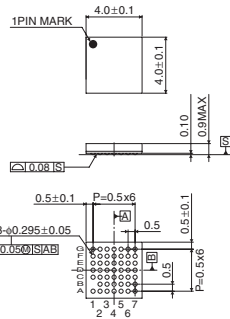

Embossed carrier tape:2,500pcs

VBGA063W050

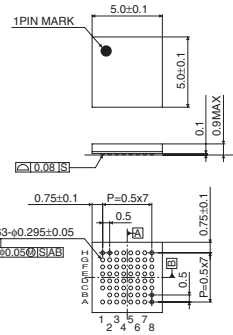

Embossed carrier tape:2,500pcs

VBGA080W050

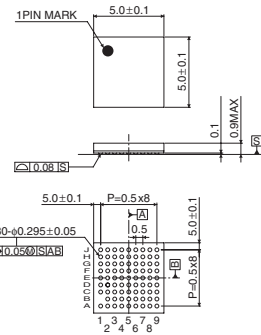

Embossed carrier tape:2,500pcs

VBGA099W060

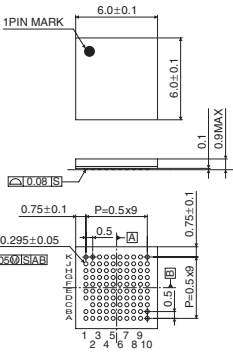

Embossed carrier tape:2,000pcs

VBGA143W070

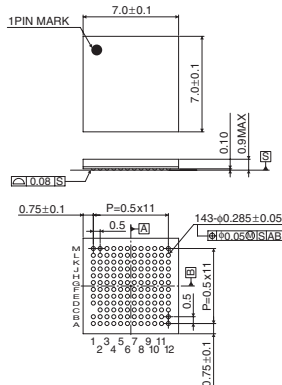

Embossed carrier tape:1,500pcs

SBGA-T <Pin Pitch:0.65mm>

SBGA063T060

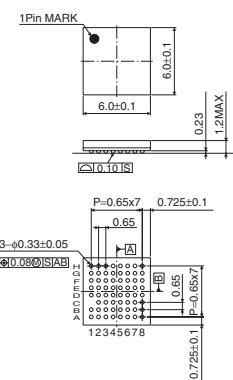

Embossed carrier tape:2,000pcs

SBGA099T070

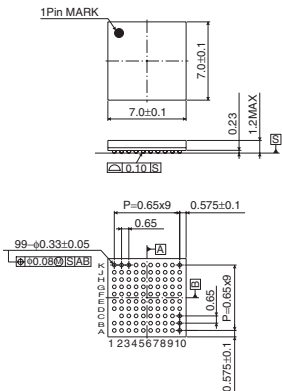

Embossed carrier tape:1,500pcs

SBGA120T080

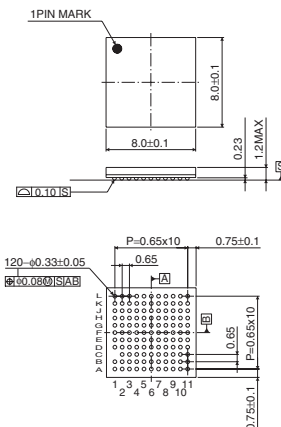

Embossed carrier tape:1,000pcs

Please refer packages from page, A142 for LAPIS Semiconductor products.

BGA Packages

(Unit: mm)

SBGA-W <Pin Pitch:0.65mm>

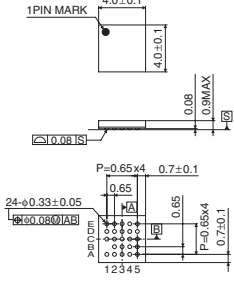
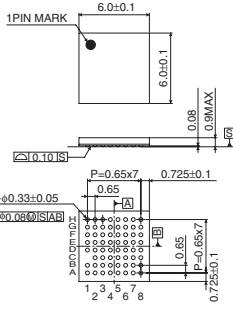
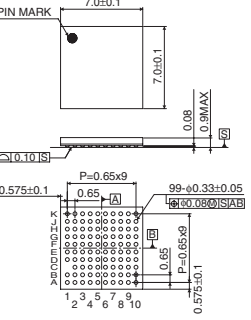
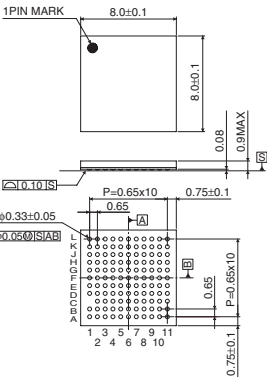
<p>SBGA024W040</p>  <p>Embossed carrier tape:2,500pcs</p>	<p>SBGA063W060</p>  <p>Embossed carrier tape:2,500pcs</p>	<p>SBGA099W070</p>  <p>Embossed carrier tape:1,500pcs</p>	<p>SBGA120W080</p>  <p>Embossed carrier tape:1,000pcs</p>
---	---	--	---

WL-CSP Packages

(Unit: mm)

VCSP <Pin Pitch:0.5mm>

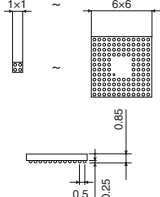
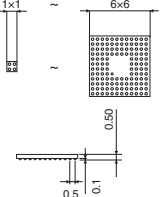
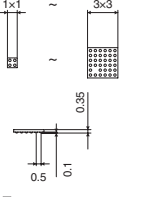
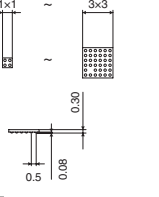
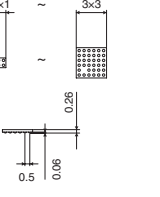
VCSP85H	VCSP50L	VCSP35L	VCSP30L	VCSP25L
 <p>2.8mm[□] and under : 3,000pcs Over 2.81mm[□] : 2,500pcs</p>	 <p>2.8mm[□] and under : 3,000pcs Over 2.81mm[□] : 2,500pcs</p>	 <p>2.8mm[□] and under : 3,000pcs Over 2.81mm[□] : 2,500pcs Embossed carrier tape:3,000pcs</p>	 <p>2.8mm[□] and under : 3,000pcs Over 2.81mm[□] : 2,500pcs Embossed carrier tape:3,000pcs</p>	 <p>Embossed carrier tape:3,000pcs</p>

UCSP <Pin Pitch:0.4mm>

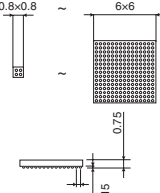
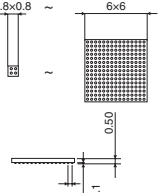
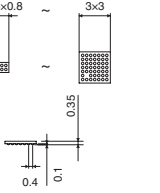
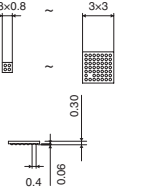
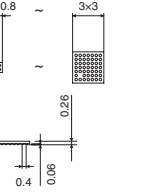
UCSP75M	UCSP50L	UCSP35L	UCSP30L	UCSP25L
 <p>2.8mm[□] and under : 3,000pcs Over 2.81mm[□] : 2,500pcs</p>	 <p>2.8mm[□] and under : 3,000pcs Over 2.81mm[□] : 2,500pcs</p>	 <p>2.8mm[□] and under : 3,000pcs Over 2.81mm[□] : 2,500pcs Embossed carrier tape:3,000pcs</p>	 <p>2.8mm[□] and under : 3,000pcs Over 2.81mm[□] : 2,500pcs Embossed carrier tape:3,000pcs</p>	 <p>Embossed carrier tape:3,000pcs</p>

XCSP <Pin Pitch:0.35mm>

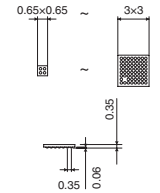
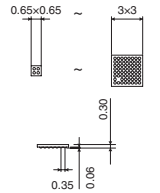
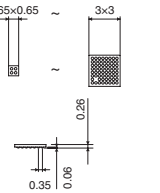
XCSP35L	XCSP30L	XCSP25L
 <p>Embossed carrier tape:3,000pcs</p>	 <p>Embossed carrier tape:3,000pcs</p>	 <p>Embossed carrier tape:3,000pcs</p>

These package size are an example. For details, please inquire to the sales.

LAPIS Semiconductor LSI Package List

No	PKG type	PKG Symbol	Title	TRAY	T&R	TUBE
1	SOP	MA	SOP8-200-1.27		2,500	
2	SOP	MA	SOP16-375-1.27	1,600	1,000	
3	SOP	MA	SOP24-430-1.27		1,000	
4	SOP	MA	SOP44-600-1.27	400	600	
5	SSOP	MB	SSOP16-0225-0.65	4,760	2,500	
6	SSOP	MB	SSOP20-44-0.65	3,600	2,500	
7	SSOP	MB	SSOP30-56-0.65	2,000	2,000	
8	SSOP	MB	SSOP32-430-1.00	1,280	1,000	
9	SSOP	MB	SSOP60-700-0.65	600	600	
9	SSOP	MB	SSOP64-525-0.80		800	
10	SSOP	MB	SSOP70-500-0.80	630	600	
11	TSOP	TA	TSSOP20-0225-0.60	4,160	2,000	
12	TSOP	TA	TSOP(1)28-08134-0.55	1,950		
13	TSOP	TA	TSOP(1)32-814-0.50	800	1,000	
14	TSOP	TA	TSOP(1)48-1220-0.50	960	1,000	
15	TSOP	TA	TSOP(1)56-1420-0.50	960	1,000	
16	TSOP	TA	TSOP(2)28-400-1.27	800	1,000	
17	TSOP	TA	TSOP(2)44/40-400-0.80	1,350	1,000	
18	TSOP	TA	TSOP(2)44-400-0.80	1,350	1,000	
19	TSOP	TA	TSOP(2)50/44-400-0.80	1,170	1,000	
20	TSOP	TA	TSOP(2)50-400-0.80	1,170	1,000	
21	TSOP	TA	TSOP(2)54-400-0.80	1,080	1,000	
22	TSOP	TA	TSOP(2)70-400-0.50	1,350	1,000	
23	TSOP	TA	TSOP(2)86-400-0.50	1,080	1,000	
24	QFP	GA	QFP44-910-0.80	1,440	1,000	
25	QFP	GA	QFP56-910-0.65	1,440	1,000	
26	QFP	GA	QFP64-1420-1.00	600		
27	QFP	GA	QFP64-1420-0.80	840		
28	QFP	GA	QFP80-1414-0.65	840		
29	QFP	GA	QFP80-1420-0.80	600		
30	QFP	GA	QFP100-1420-0.65	600		
31	QFP	GA	QFP100-1414-0.50	750		
32	QFP	GA	QFP128-1420-0.50	420		
33	QFP	GA	QFP128-2828-0.80	240		
34	QFP	GA	QFP208-2828-0.50	240		
35	QFP	GA	LQFP144-2020-0.50	600		

No	PKG type	PKG Symbol	Title	TRAY	T&R	TUBE
36	QFP	GA	LQFP176-2424-0.50	400		
36	QFP	TA	TQFP32-0707-0.80	2,500	1,000	
37	QFP	TA	TQFP44-1010-0.80	1,600	1,000	
38	QFP	TA	TQFP48-0707-0.50	2,500	1,000	
39	QFP	TA	TQFP52-1010-0.65	1,600	1,000	
40	QFP	TA	TQFP64-1010-0.50	1,600	1,000	
40	QFP	TA	TQFP80-1010-0.40	1,600		
40	QFP	TA	TQFP80-1212-0.50	960/1,090		
41	QFP	TA	TQFP80-1414-0.65	900		
42	QFP	TA	TQFP100-1414-0.50	900		
43	QFP	TA	TQFP120-1414-0.40	900		
44	QFP	TA	TQFP128-1414-0.40	900		
44	DIP	-	DIP8-300-2.54			1,400
45	QFN	GD	WQFN12-0303-0.50	6,240	1,000	
46	QFN	GD	WQFN16-0303-0.50	6,240	1,000	
47	QFN	GD	WQFN16-0404-0.50	4,900	1,000	
48	QFN	GD	WQFN20-0404-0.50	4,900	1,000	
49	QFN	GD	WQFN24-0404-0.50	4,900	1,000	
50	QFN	GD	WQFN28-0404-0.40	4,900	1,000	
51	QFN	GD	WQFN32-0505-0.50	4,030	1,000	
52	QFN	GD	WQFN36-0606-0.50	4,900	2,000	
53	QFN	GD	WQFN40-0505-0.40	4,030	1,000	
54	QFN	GD	WQFN40-0606-0.50	4,900	2,500	
55	QFN	GD	WQFN48-0707-0.50	2,500	2,000	
56	QFN	GD	WQFN52-0707-0.40	2,500	2,000	
57	QFN	GD	WQFN64-0909-0.50	2,600	3,000	
58	QFN	GD	WQFN80-0909-0.40	2,600	3,000	
59	BGA	LA	LFPGA48	4,160		
60	BGA	LA	LFPGA84	2,600		
61	BGA	LA	LFPGA144	1,760		
62	BGA	LA	LFPGA324	840		
63	BGA	LA	TFBGA60	3,360		
64	BGA	LA	TFBGA64	4,180		
65	BGA	LA	TFBGA90	1,710		
66	BGA	LA	P-TFBGA144	1,760		
67	BGA	LA	TFBGA208-0909-0.50	2,600		
68	BGA	LA	TFBGA208-1212-0.65	1,680		

*Regarding an unstated package, please inquire to the sales.

LAPIS Semiconductor LSI Part No. Explanation

Product names are assigned to our semiconductor devices using the following convention, starting with the character "M".

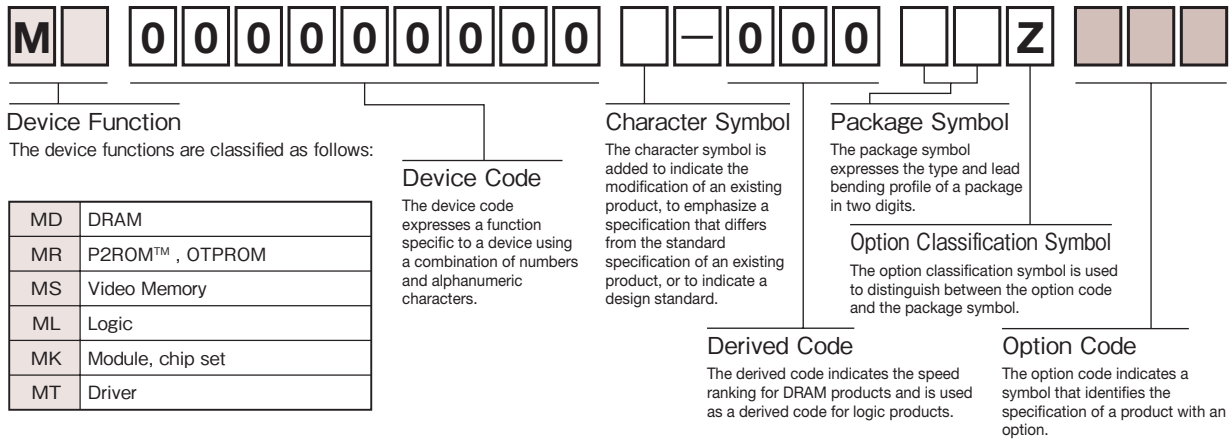

The following shows the convention of item name assignment for conventional products.

• The actual package profile is not shown here.

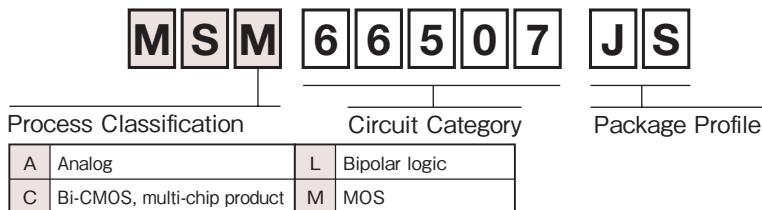

These package size are an example. For details, please inquire to the sales.

SOP Packages

(Unit: mm)

SOP

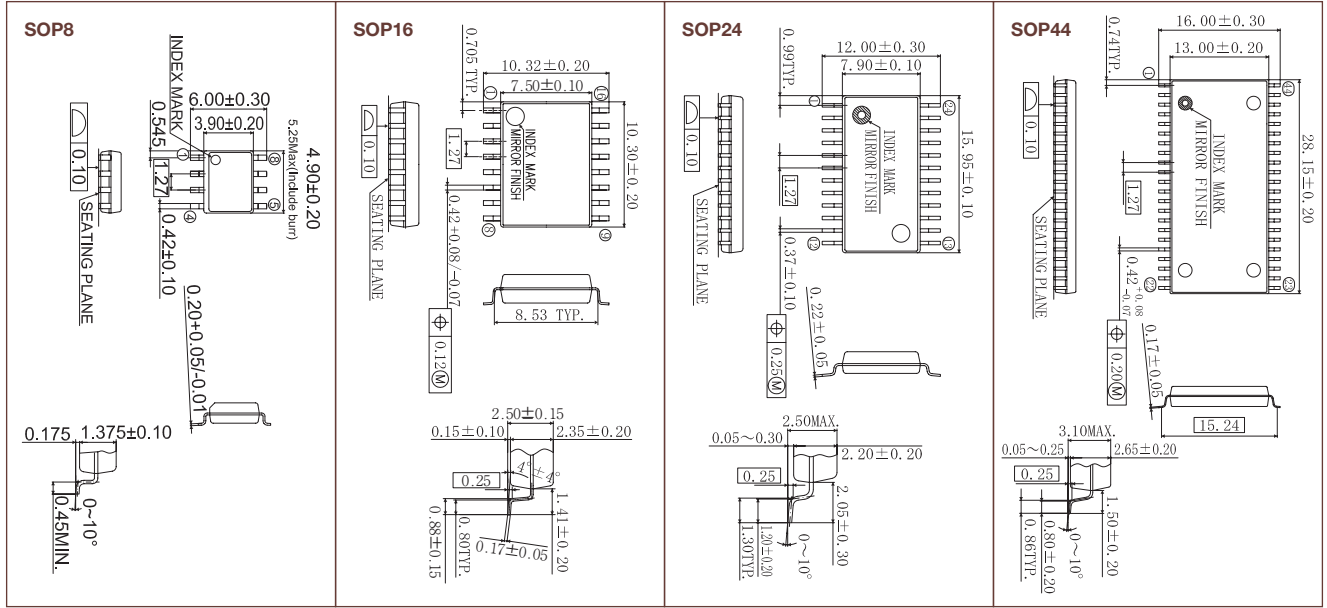

SSOP

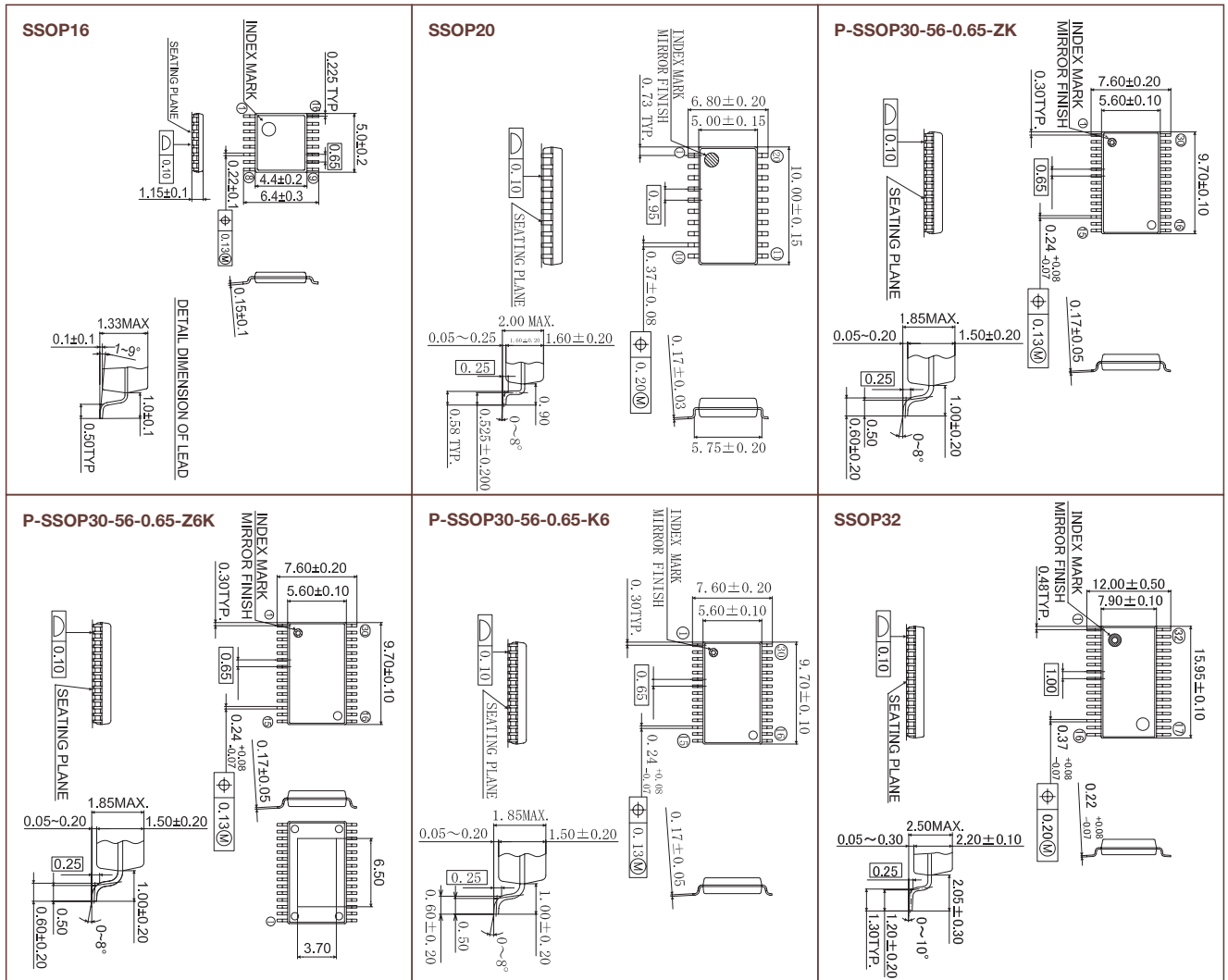

A

IC Packages

These package size are an example. For details, please inquire to the sales.

SOP Packages

(Unit: mm)

SSOP

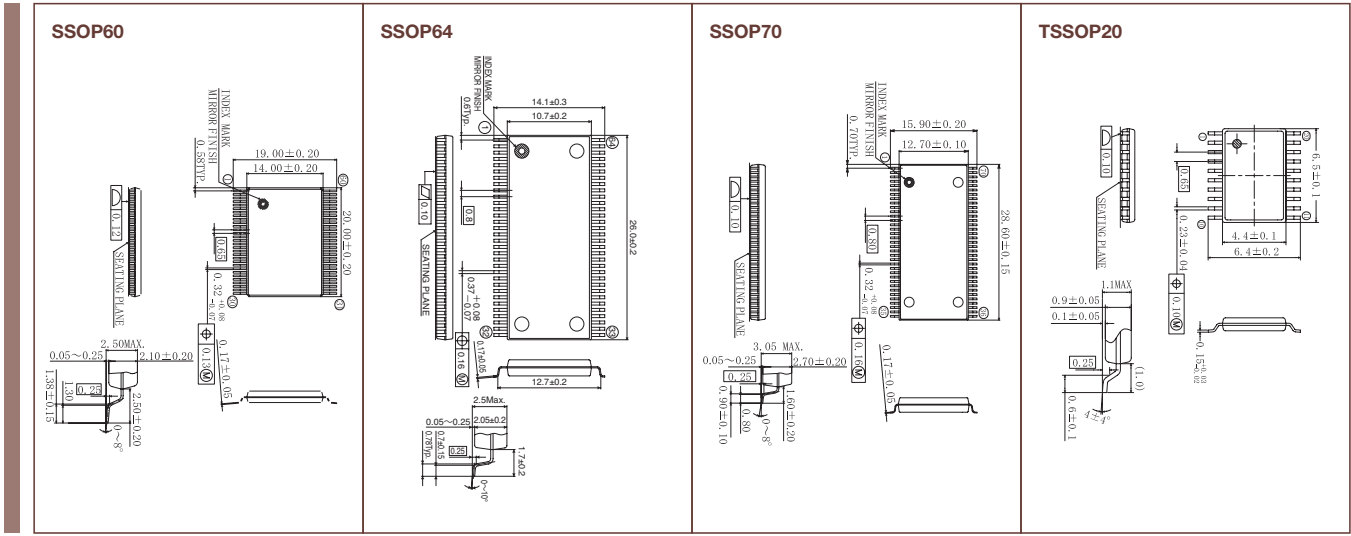

TSOP(Type I)

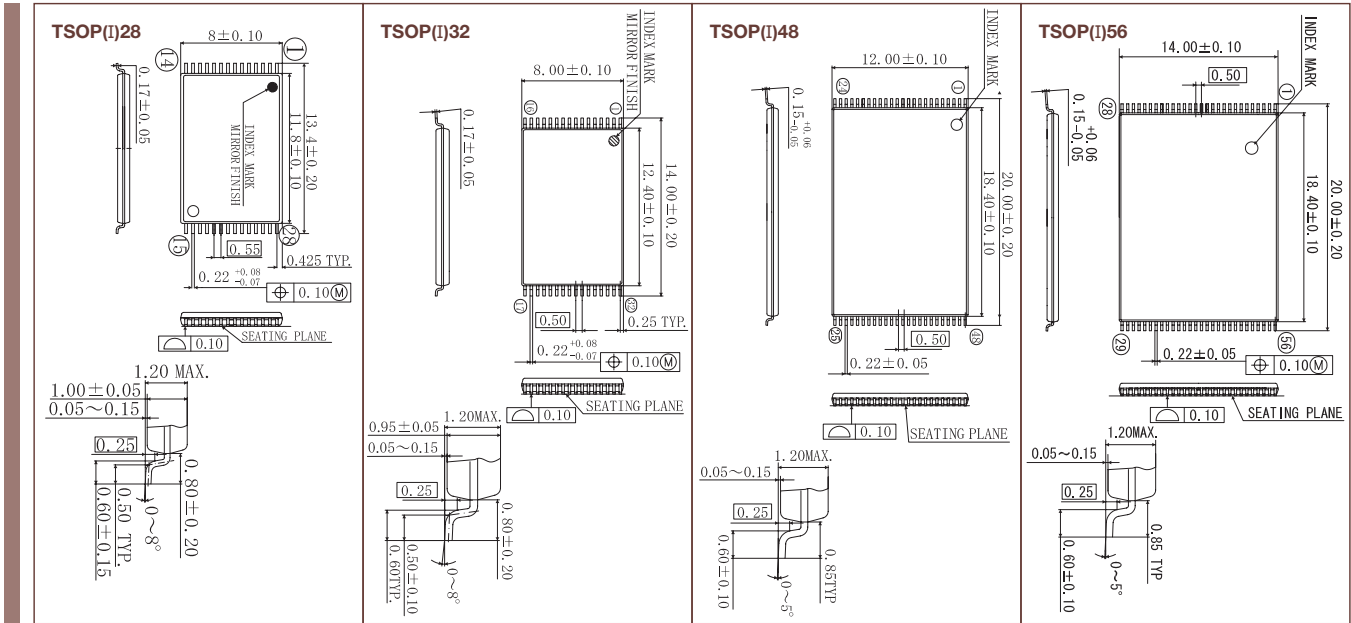

TSOP(Type II)

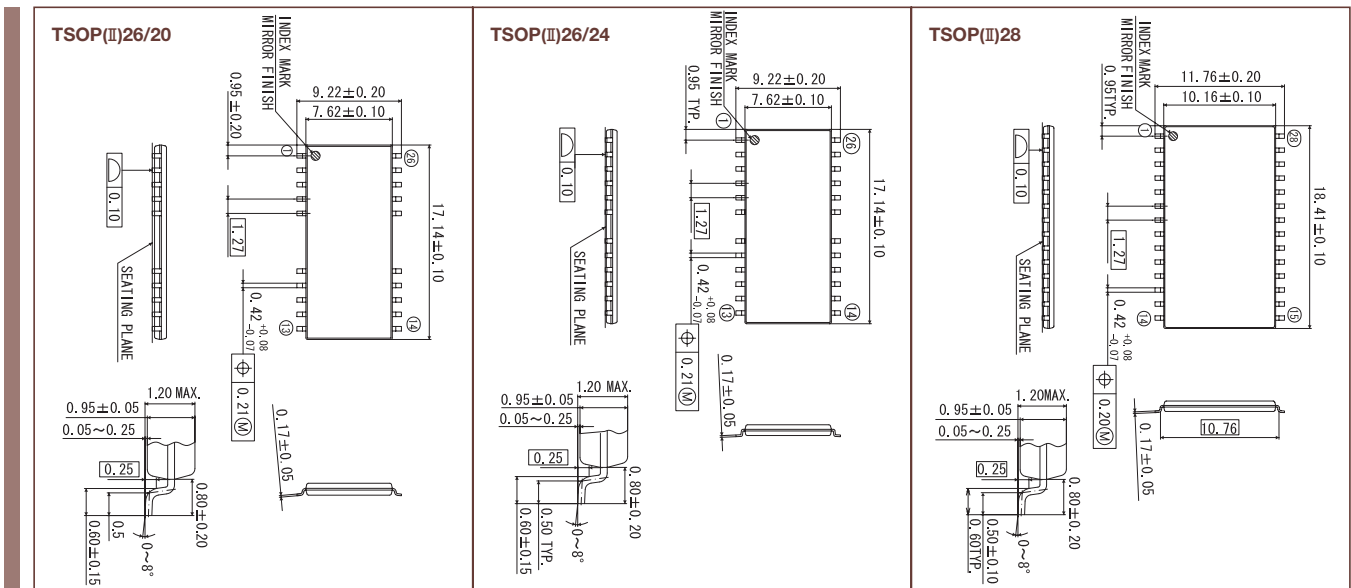

These package size are an example. For details, please inquire to the sales.

SOP Packages

(Unit: mm)

TSOP(Type II)

TSOP(II)44/40

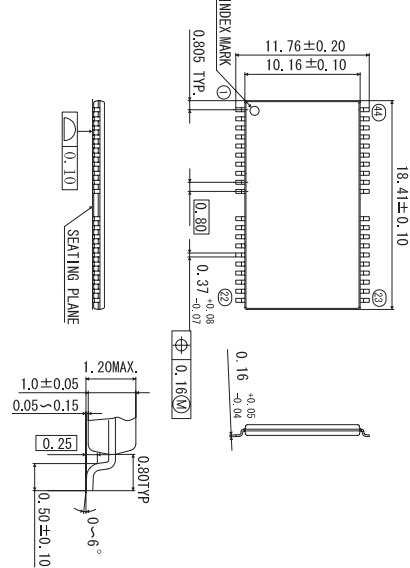

TSOP(II)44

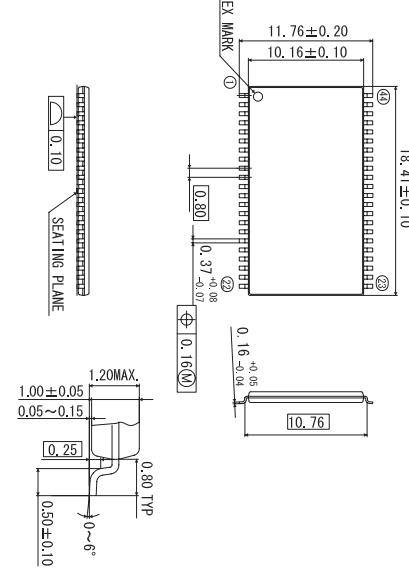

TSOP(II)50/44

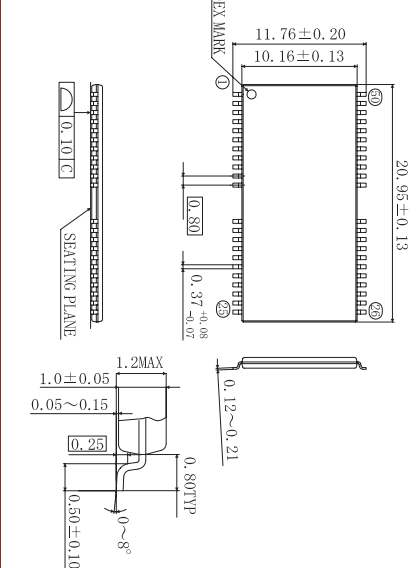

TSOP(II)50

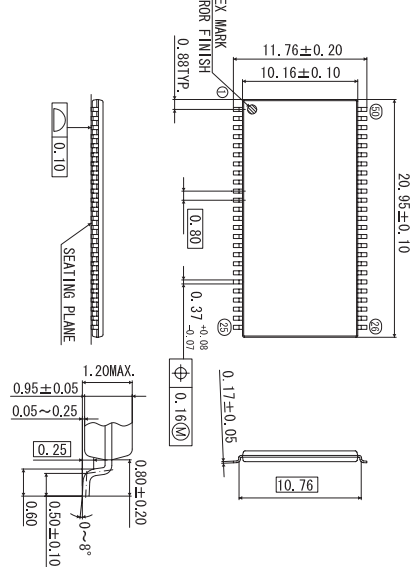

TSOP(II)54

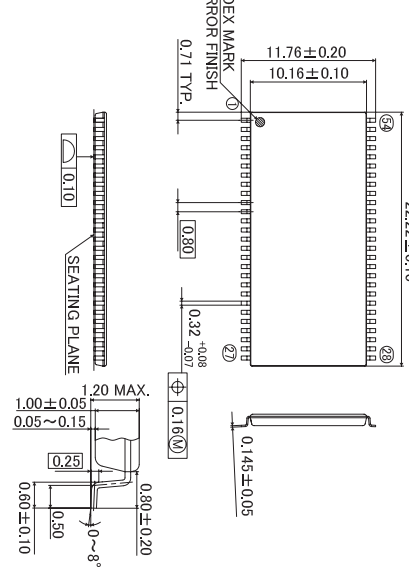

TSOP(II)66

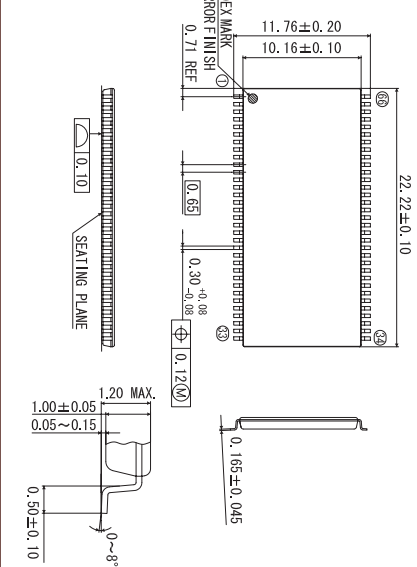

TSOP(II)70

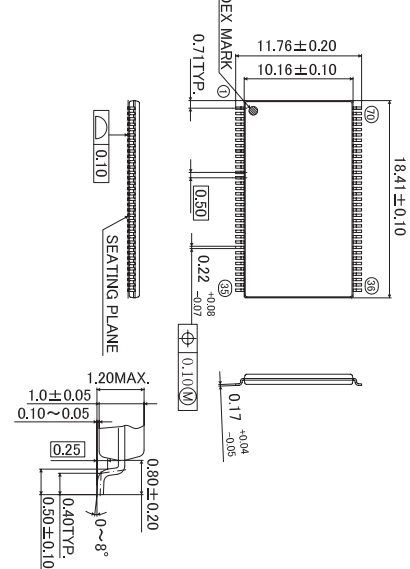

TSOP(II)86

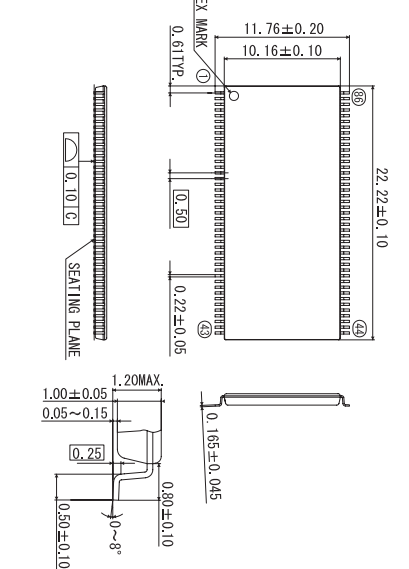

A

IC Packages

These package size are an example. For details, please inquire to the sales.

QFP Packages

(Unit: mm)

QFP

<p>QFP44</p>	<p>QFP56</p>	<p>QFP64-P-1420-1.00</p>	<p>P-QFP64-1414-0.80</p>
<p>P-QFP80-1414-0.65</p>	<p>QFP80-P-1420-0.80</p>	<p>P-QFP100-1420-0.65-TK</p>	<p>QFP100-P-1420-0.65-BK</p>
<p>P-QFP100-1414-0.50-K</p>	<p>P-QFP128-1420-0.50</p>	<p>QFP128-P-2828-0.80</p>	<p>QFP208</p>

These package size are an example. For details, please inquire to the sales.

QFP Packages

(Unit: mm)

LQFP

LQFP32

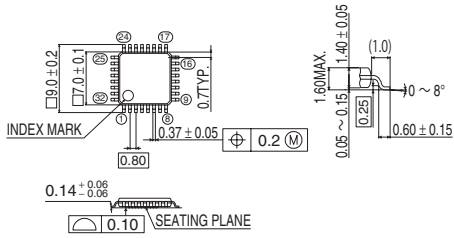

LQFP144

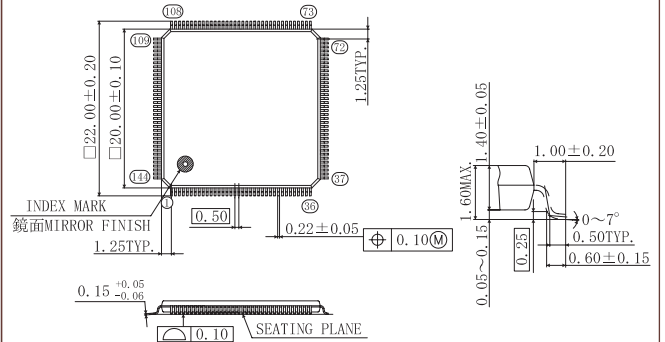

LQFP176

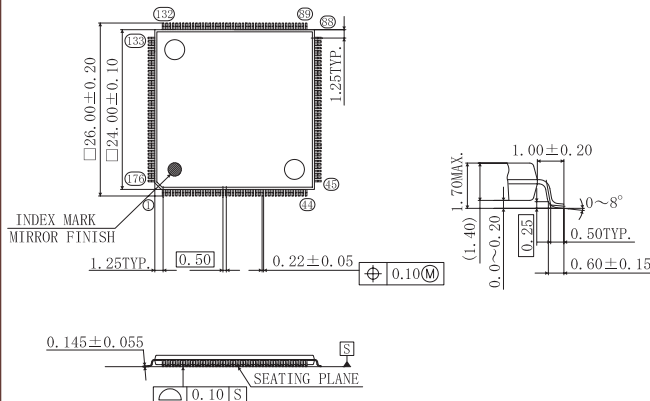

TQFP

TQFP44

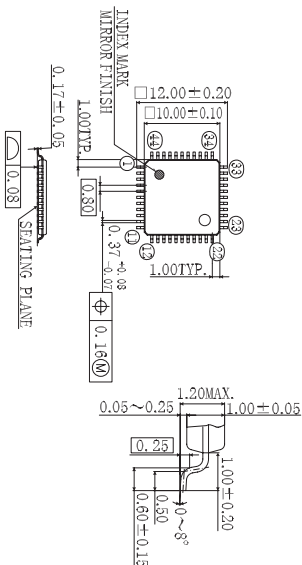

TQFP48

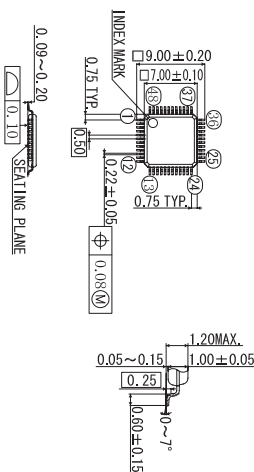

TQFP52

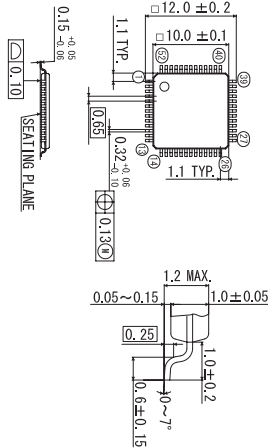

TQFP64

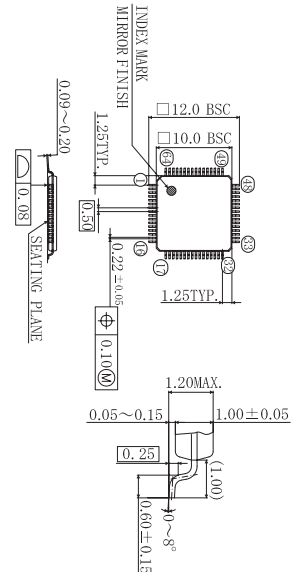

These package size are an example. For details, please inquire to the sales.

QFP Packages

(Unit: mm)

TQFP

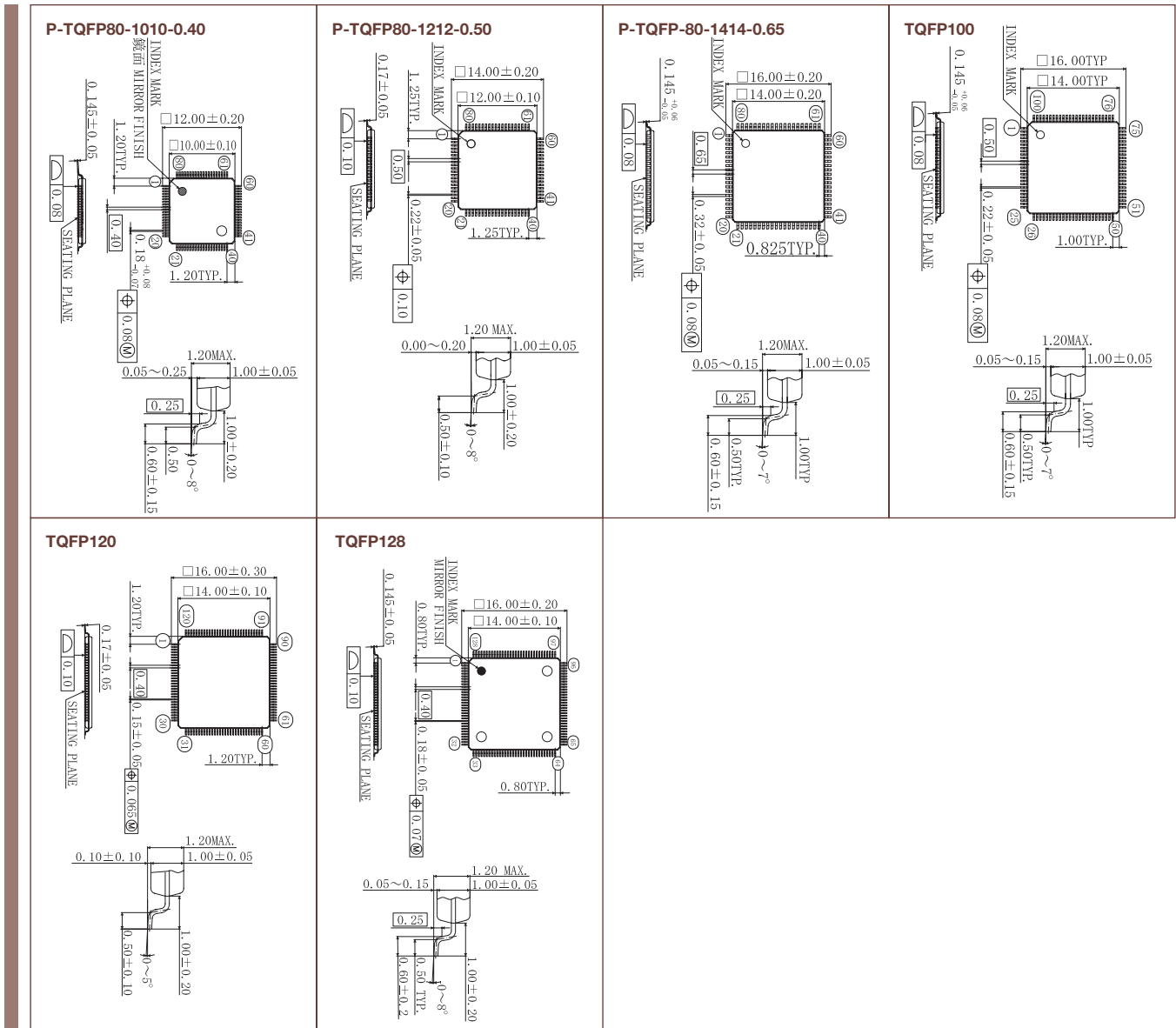

DIP Package

(Unit: mm)

DIP8

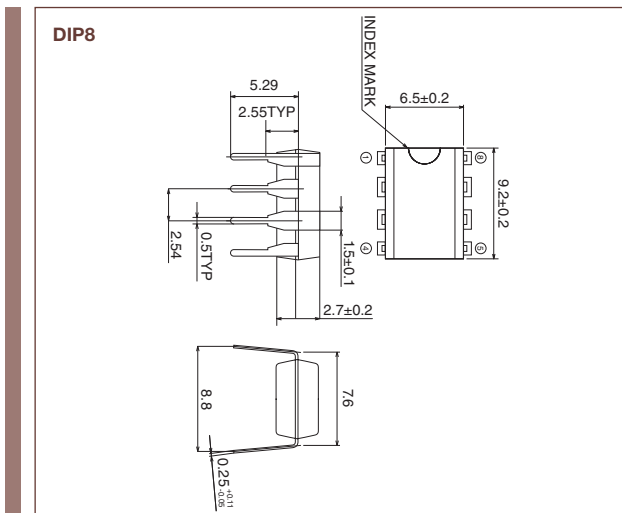

These package size are an example. For details, please inquire to the sales.

QFN Packages

(Unit: mm)

VQFN

VQFN28

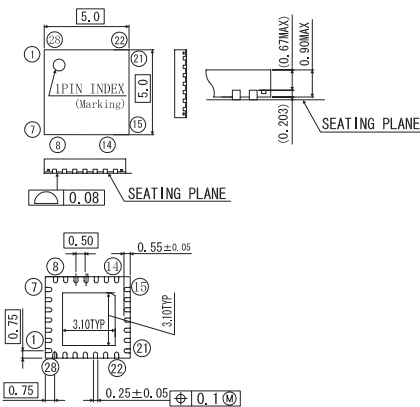

VQFN32

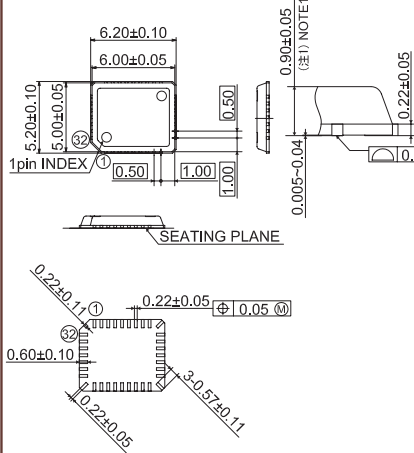

VQFN48

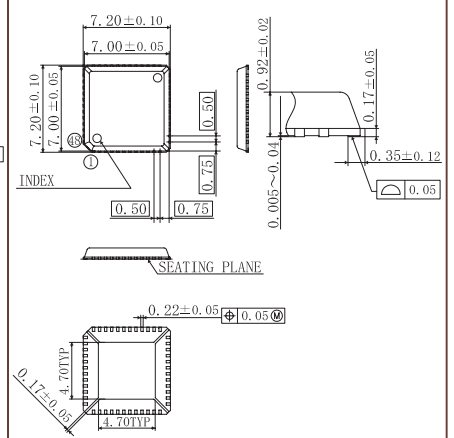

WQFN

WQFN12

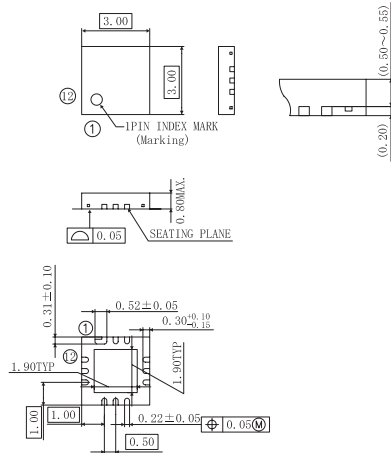

WQFN16-0303-0.50

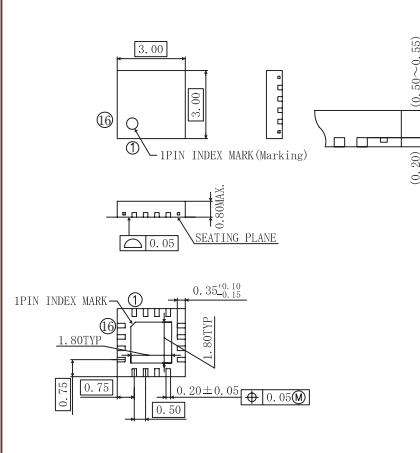

WQFN16-0404-0.50

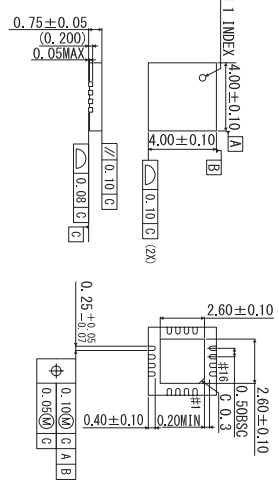

WQFN20

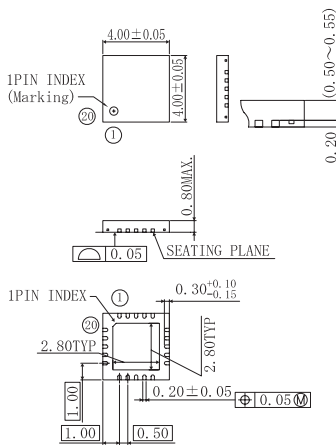

WQFN24

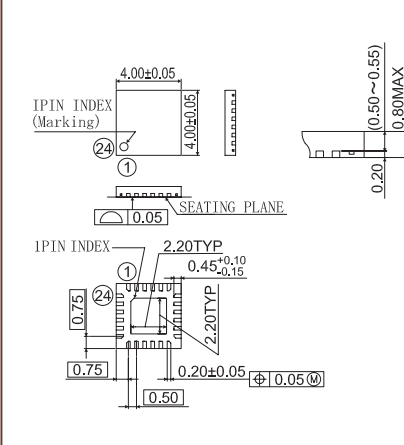

P-WQFN28-0404-0.40-63

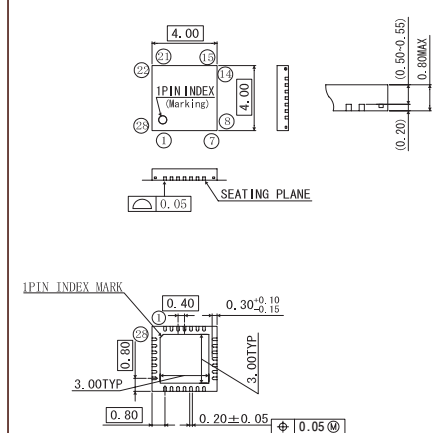

These package size are an example. For details, please inquire to the sales.

QFN Packages

(Unit: mm)

WQFN

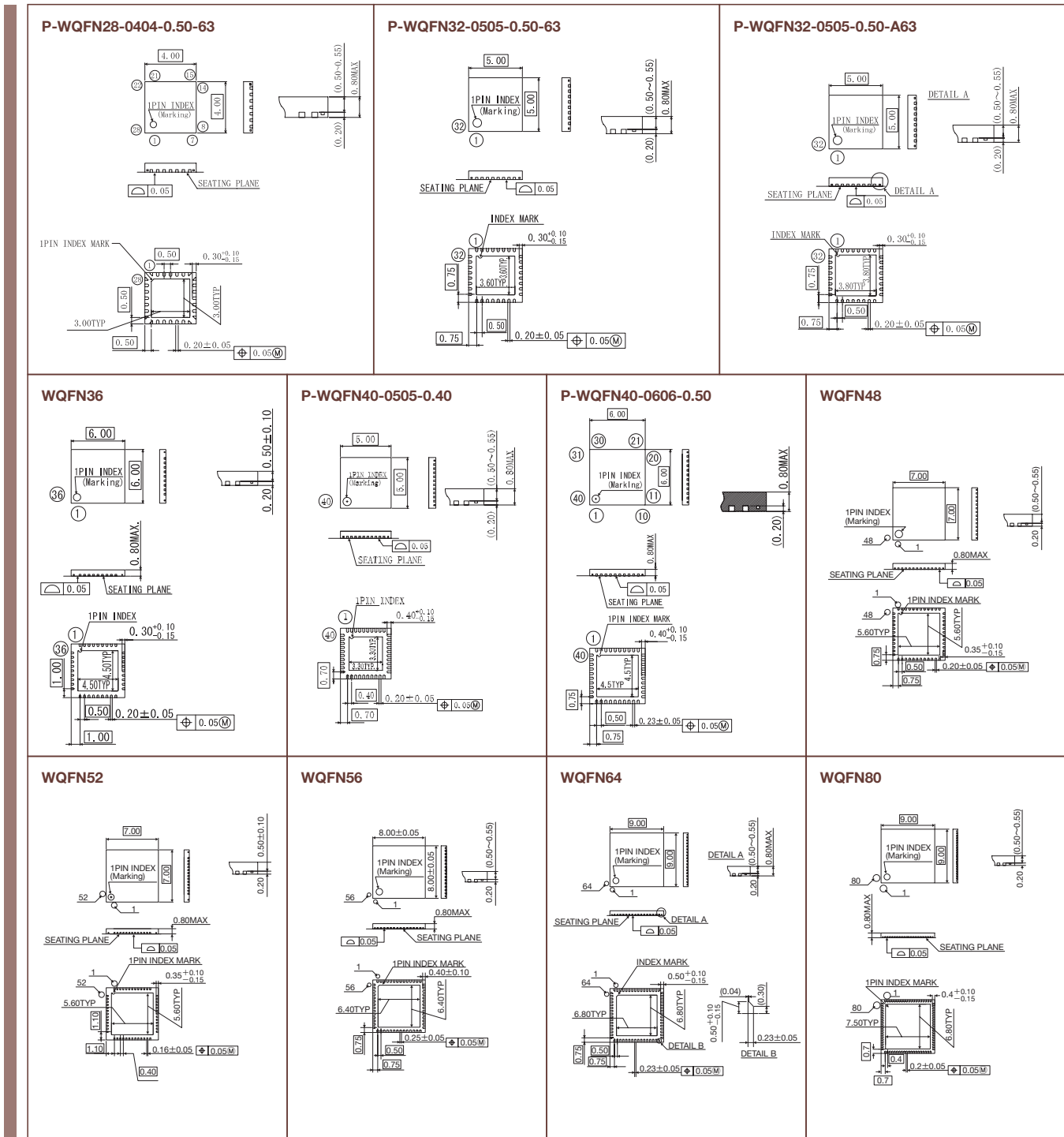

C-QFN

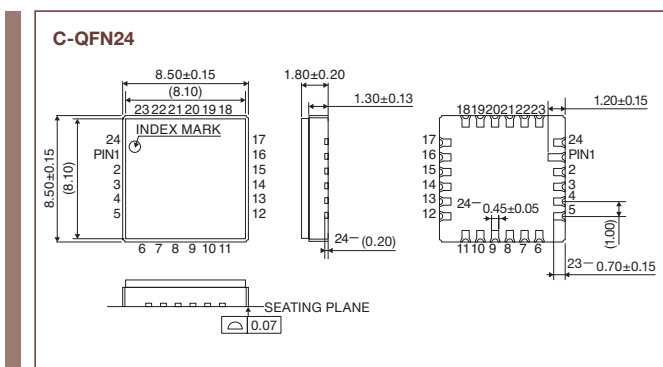

WSON Package

(Unit: mm)

WSON

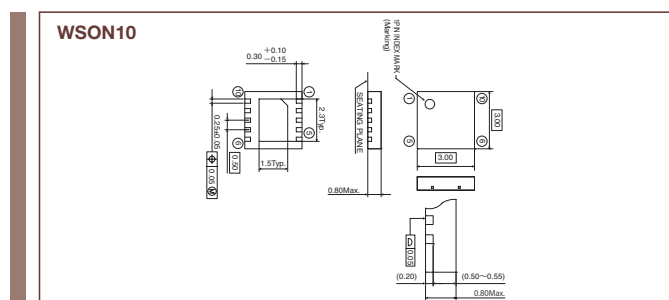

These package size are an example. For details, please inquire to the sales.

BGA Packages

(Unit: mm)

BGA

BGA252

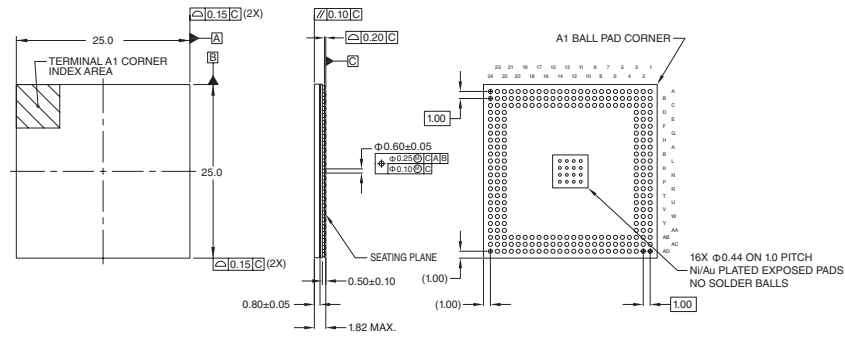

LFBGA

LFBGA48

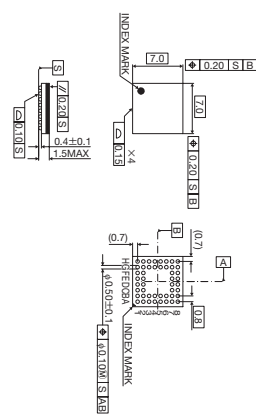

LFBGA84

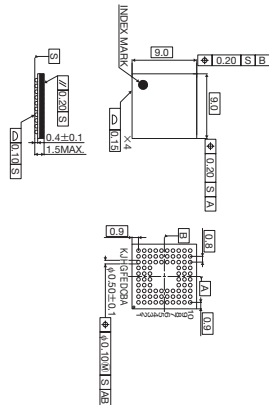

LFBGA144

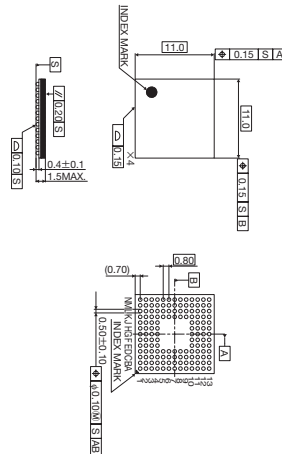

LFBGA324

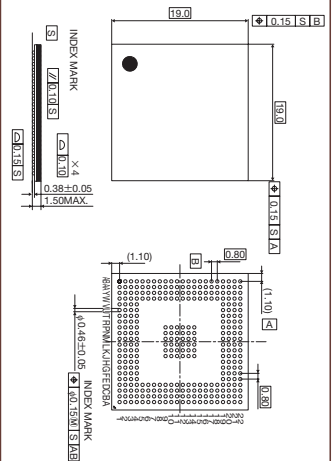

TFBGA

TFBGA60

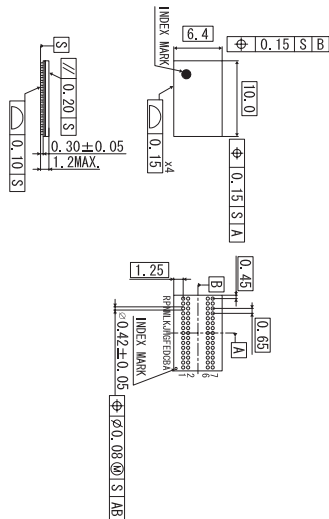

TFBGA64

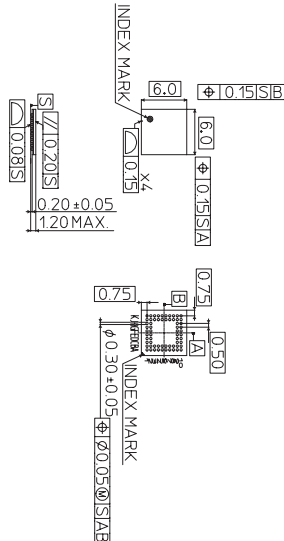

TFBGA84

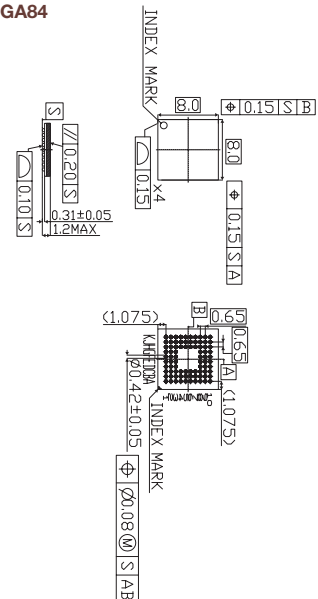

These package size are an example. For details, please inquire to the sales.

BGA Packages

(Unit: mm)

TFBGA

TFBGA90

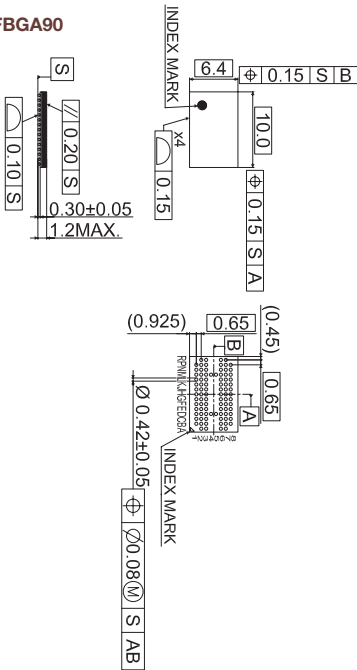

P-TFBGA144

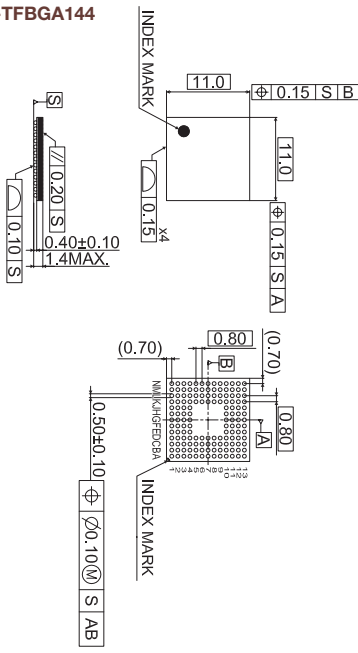

TFBGA176

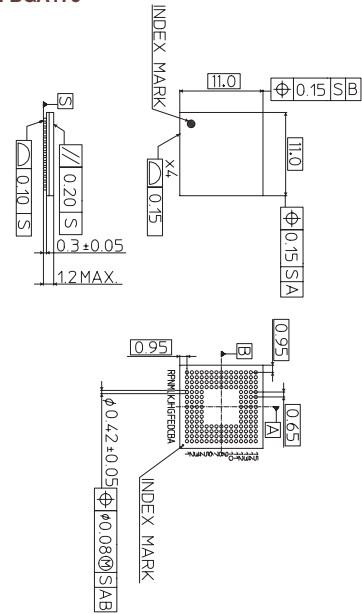

P-TFBGA208-0909-0.50

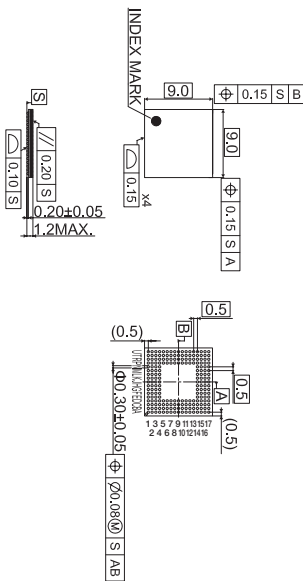

P-TFBGA208-1212-0.65

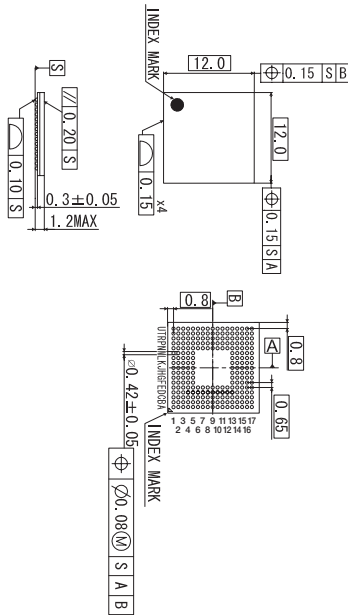

LGA Package

(Unit: mm)

FLGA

FLGA140

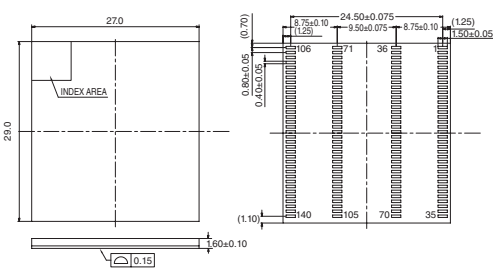

WL-CSP Package

(Unit: mm)

WCSP

WCSP67

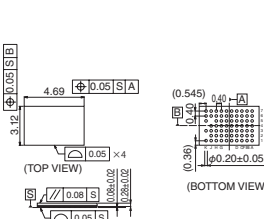

WL-CSP34

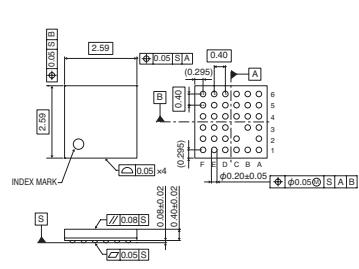



Power Devices

SiC Power Devices

CONTENTS

■ SiC Schottky Barrier Diodes	P. B2
■ SiC MOSFET	P. B5
■ Full SiC Power Modules	P. B7





B

SiC Power Devices



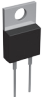

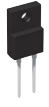

ISO9001- / ISO / TS 16949-approved

SiC Schottky Barrier Diodes

● Quick Reference for SiC-Schottky Barrier Diodes

V _{RM} (V)	I _F (A)	Leaded type				Surface Mounted type				
		 TO-220AC	 TO-220ACP	 TO-220FM	 TO-247	 TO-263AB (LPTL)				
650	2		New SCS302AP	25						
	4		New SCS304AP	26						
	6	SCS206AG SCS206AGHR	13 19 New SCS306AP	27	SCS206AM	30		SCS206AJ SCS206AJHR	1 7	
	8	SCS208AG SCS208AGHR	14 20 New SCS308AP	28	SCS208AM	31		SCS208AJ SCS208AJHR	2 8	
	10	SCS210AG SCS210AGHR	15 21 New SCS310AP	29	SCS210AM	32		SCS210AJ SCS210AJHR	3 9	
	12	SCS212AG SCS212AGHR	16 22		SCS212AM	33		SCS212AJ SCS212AJHR	4 10	
	15	SCS215AG SCS215AGHR	17 23		SCS215AM	34	SCS215AE	36	SCS215AJ SCS215AJHR	5 11
	20	SCS220AG SCS220AGHR	18 24		SCS220AM	35	SCS220AE SCS220AE2 SCS220AE2HR	37 38 41	SCS220AJ SCS220AJHR	6 12
	30						SCS230AE2 SCS230AE2HR	39 42		
	40						SCS240AE2 SCS240AE2HR	40 43		
1,200	5	SCS205KG SCS205KGHR	44 48							
	10	SCS210KG SCS210KGHR	45 49				SCS210KE2 SCS210KE2HR	52 56		
	15	SCS215KG SCS215KGHR	46 50							
	20	SCS220KG SCS220KGHR	47 51				SCS220KE2 SCS220KE2HR	53 57		
	30						SCS230KE2 SCS230KE2AHR	54 58		
	40						SCS240KE2 SCS240KE2AHR	55 59		

Note: Package is JEDEC code. () :ROHM Packages

SiC Schottky Barrier Diodes												
No.	Part No.	Absolute Maximum Ratings(Ta=25°C)				Electrical Characteristics(Ta=25°C)				Package	Equivalent Circuit Diagram	Automotive Grade AEC-Q101*2
		V _{RM} (V)	V _R (V)	I _F (A)	I _{FSM} (A) 50Hz,1~	V _F (V) Typ.	I _F (A)	I _R (μA) Max.	V _R (V)			
1	SCS206AJ	650	650	6	22	1.35	6	120	600	TO-263AB (LPTL)		—
2	SCS208AJ	650	650	8	29	1.35	8	160	600			—
3	SCS210AJ	650	650	10	38	1.35	10	200	600			—
4	SCS212AJ	650	650	12	42	1.35	12	240	600			—
5	SCS215AJ	650	650	15	52	1.35	15	300	600			—
6	SCS220AJ	650	650	20	67	1.35	20	400	600			—
7	SCS206AJHR	650	650	6	22	1.35	6	120	600			YES
8	SCS208AJHR	650	650	8	29	1.35	8	160	600			YES
9	SCS210AJHR	650	650	10	38	1.35	10	200	600			YES
10	SCS212AJHR	650	650	12	42	1.35	12	240	600			YES
11	SCS215AJHR	650	650	15	52	1.35	15	300	600			YES
12	SCS220AJHR	650	650	20	67	1.35	20	400	600			YES
13	SCS206AG	650	650	6	22	1.35	6	120	600	TO-220AC		—
14	SCS208AG	650	650	8	29	1.35	8	160	600			—
15	SCS210AG	650	650	10	38	1.35	10	200	600			—
16	SCS212AG	650	650	12	42	1.35	12	240	600			—
17	SCS215AG	650	650	15	52	1.35	15	300	600			—
18	SCS220AG	650	650	20	67	1.35	20	400	600			—
19	SCS206AGHR	650	650	6	22	1.35	6	120	600			YES
20	SCS208AGHR	650	650	8	29	1.35	8	160	600			YES
21	SCS210AGHR	650	650	10	38	1.35	10	200	600			YES
22	SCS212AGHR	650	650	12	42	1.35	12	240	600			YES
23	SCS215AGHR	650	650	15	52	1.35	15	300	600			YES
24	SCS220AGHR	650	650	20	67	1.35	20	400	600			YES
25	New SCS302AP	650	650	2	19	1.35	2	10.8	650	TO-220ACP		—
26	New SCS304AP	650	650	4	27	1.35	4	20	650			—
27	New SCS306AP	650	650	6	47	1.35	6	30	650			—
28	New SCS308AP	650	650	8	67	1.35	8	40	650			—
29	New SCS310AP	650	650	10	82	1.35	10	50	650			—
30	SCS206AM	650	650	6	22	1.35	6	120	600	TO-220FM		—
31	SCS208AM	650	650	8	29	1.35	8	160	600			—
32	SCS210AM	650	650	10	38	1.35	10	200	600			—
33	SCS212AM	650	650	12	42	1.35	12	240	600			—
34	SCS215AM	650	650	15	52	1.35	15	300	600			—
35	SCS220AM	650	650	20	67	1.35	20	400	600			—
36	SCS215AE	650	650	15	52	1.35	15	300	600	TO-247		—
37	SCS220AE	650	650	20	67	1.35	20	400	600			—
38	SCS220AE2	650	650	10/20*1	38/76*1	1.35	10	200	600			—
39	SCS230AE2	650	650	15/30*1	52/104*1	1.35	15	300	600			—
40	SCS240AE2	650	650	20/40*1	67/135*1	1.35	20	400	600			—
41	SCS220AE2HR	650	650	10/20*1	38/76*1	1.35	10	200	600			YES
42	SCS230AE2HR	650	650	15/30*1	52/104*1	1.35	15	300	600			YES
43	SCS240AE2HR	650	650	20/40*1	67/135*1	1.35	20	400	600	YES		
44	SCS205KG	1,200	1,200	5	22	1.4	5	100	1,200	TO-220AC		—
45	SCS210KG	1,200	1,200	10	42	1.4	10	200	1,200			—
46	SCS215KG	1,200	1,200	15	62	1.4	15	300	1,200			—
47	SCS220KG	1,200	1,200	20	78	1.4	20	400	1,200			—
48	SCS205KGHR	1,200	1,200	5	22	1.4	5	100	1,200			YES
49	SCS210KGHR	1,200	1,200	10	42	1.4	10	200	1,200			YES
50	SCS215KGHR	1,200	1,200	15	62	1.4	15	300	1,200			YES
51	SCS220KGHR	1,200	1,200	20	78	1.4	20	400	1,200			YES
52	SCS210KE2	1,200	1,200	5/10*1	22/45*1	1.4	5	100	1,200			—
53	SCS220KE2	1,200	1,200	10/20*1	42/84*1	1.4	10	200	1,200			—
54	SCS230KE2	1,200	1,200	15/30*1	62/124*1	1.4	15	300	1,200	—		
55	SCS240KE2	1,200	1,200	20/40*1	78/157*1	1.4	20	400	1,200	—		
56	SCS210KE2HR	1,200	1,200	5/10*1	22/45*1	1.4	5	100	1,200	YES		
57	SCS220KE2HR	1,200	1,200	10/20*1	42/84*1	1.4	10	200	1,200	YES		
58	SCS230KE2AHR	1,200	1,200	15/30*1	62/124*1	1.4	15	300	1,200	YES		
59	SCS240KE2AHR	1,200	1,200	20/40*1	78/157*1	1.4	20	400	1,200	YES		

Note: Package is JEDEC code. () :ROHM Packages

*1: (Per Leg/Device) *2: Rev.C

SiC Schottky Barrier Diodes

●Dimensions (Unit : mm)

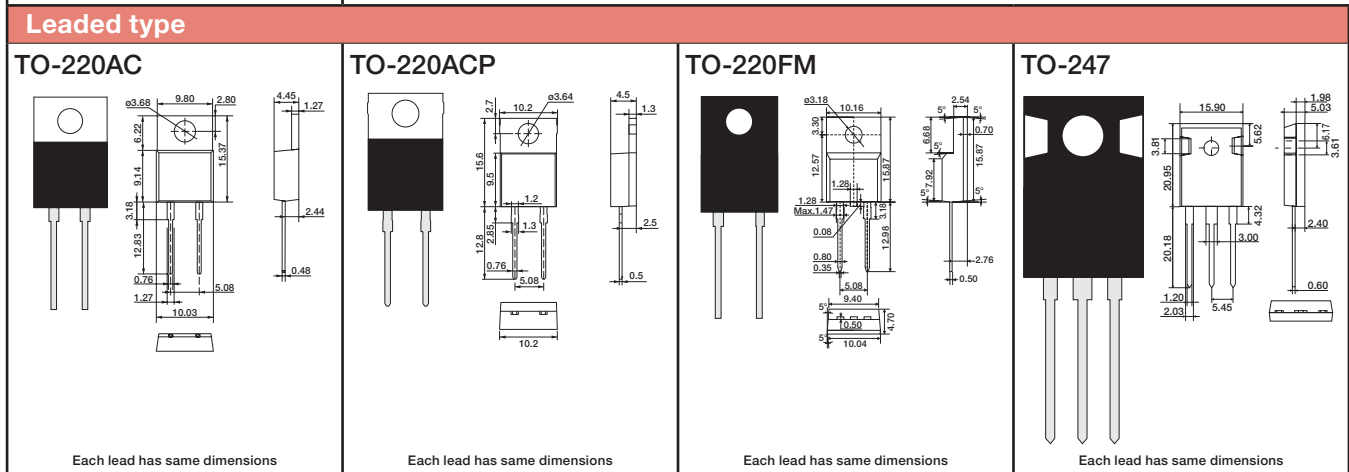
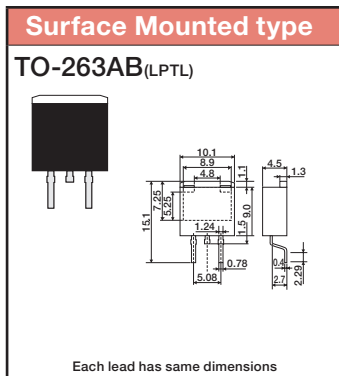

Note: Package is JEDEC code. () :ROHM Packages

●Part No. Explanation

●Schottky Barrier Diode Part No. Explanation

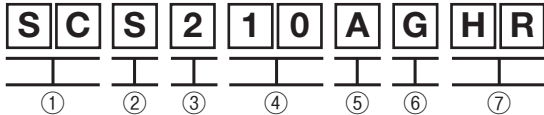

- ① SiC Discrete Device
- ② Schottky Barrier Diode
- ③ Generation
- ④ Rated Current(A)
Example 05 → 5A
10 → 10A

- ⑤ Rated Voltage
Example A → 650V
K → 1,200V
- ⑥ Package
Example J → TO-263AB(LPTL)
G → TO-220AC
P → TO-220ACP
M → TO-220FM
E → TO-247
E2 → TO-247(Dual Chip)
- ⑦ Automotive Grade



●Packaging type

Package	Code	Packaging Style	Basic Ordering Unit(pcs)
TO-263AB(LPTL)	TLL	Embossed Tape	1,000
TO-220AC	C	Tube	50
TO-220ACP	C9	Tube	50
TO-220FM	C	Tube	50
TO-247	C	Tube	30

Note: Package is JEDEC code. () :ROHM Packages

SiC MOSFET

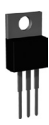
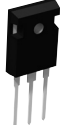
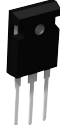
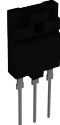
Quick Reference for SiC MOSFET

V _{DSS} (V)	R _{DS(on)} (mΩ)	Leaded type				Surface Mounted type	SiC SBD	
								
		TO-220AB	TO-247	TO-247N	TO-3PFM	TO-268-2L		
400	120	SCTMU001F (MUSIC SERIES) 25					—	
650	17			SCT3017AL 1			—	
	22			SCT3022AL 2			—	
	30			SCT3030AL 3			—	
	60			SCT3060AL 4			—	
	80			New SCT3080AL 5			—	
1,200	120	SCT2120AF 7		SCT3120AL 6			—	
	22			SCT3022KL 8			—	
	30			SCT3030KL 9			—	
	40			SCT3040KL 10			—	
	80			SCT2080KE 14	SCT3080KL 11			Co-packed
				SCH2080KE 13				—
			☆SCT2080KEAHR 15					—
	160			SCT2160KE 16	SCT3160KL 12			—
				☆SCT2160KEAHR 17				—
	280			SCT2280KE 18				—
				☆SCT2280KEAHR 19				—
450			SCT2450KE 20				—	
			☆SCT2450KEAHR 21				—	
1,700	1,150				SCT2H12NZ 24	New SCT2H12NY 22	—	
	750					New SCT2750NY 23	—	

Note: Package is JEDEC code.

☆ : Under Development

SiC MOSFET

SWITCHING SERIES											
No.	Part No.	Polarity (ch)	V _{DSS} (V)	I _D (A)	P _D (W) (T _c =25°C)	R _{DS(on)} Typ.(mΩ)	Q _g Typ.(nC)		Package	Automotive Grade AEC-Q101	
						V _{GS} =18V	V _{GS} =18V	Drive Voltage (V)			
1	SCT3017AL	N	650	118	427	17	172	18	TO-247N	—	
2	SCT3022AL	N	650	93	339	22	133	18		—	
3	SCT3030AL	N	650	70	262	30	104	18		—	
4	SCT3060AL	N	650	39	165	60	58	18		—	
5	New SCT3080AL	N	650	30	134	80	48	18		—	
6	SCT3120AL	N	650	21	103	120	38	18	TO-220AB	—	
7	SCT2120AF	N	650	29	165	120	61	18		—	
8	SCT3022KL	N	1,200	95	427	22	178	18		—	
9	SCT3030KL	N	1,200	72	339	30	131	18		—	
10	SCT3040KL	N	1,200	55	262	40	107	18		TO-247N	—
11	SCT3080KL	N	1,200	31	165	80	60	18		—	
12	SCT3160KL	N	1,200	17	103	160	42	18		—	
13	SCH2080KE	N	1,200	40	262	80	106	18		TO-247	—
14	SCT2080KE	N	1,200	40	262	80	106	18			—
15	☆SCT2080KEAHR	N	1,200	40	262	80	106	18			YES
16	SCT2160KE	N	1,200	22	165	160	62	18			—
17	☆SCT2160KEAHR	N	1,200	22	165	160	62	18	YES		
18	SCT2280KE	N	1,200	14	108	280	35	18	—		
19	☆SCT2280KEAHR	N	1,200	14	108	280	35	18	YES		
20	SCT2450KE	N	1,200	10	85	450	27	18	—		
21	☆SCT2450KEAHR	N	1,200	10	85	450	27	18	YES		
22	New SCT2750NY	N	1,700	5.9	57	750	17	18	TO-268-2L	—	
23	New SCT2H12NY	N	1,700	4	44	1,150	14	18		—	
24	SCT2H12NZ	N	1,700	3.7	35	1,150	14	18	TO-3PFM	—	
MUSIC SERIES											
25	SCTMU001F	N	400	20	132	120	59	18	TO-220AB	—	

Note: Package is JEDEC code.

☆ : Under Development

SiC-MOSFET

Dimensions (Unit : mm)

Surface Mounted type

TO-268-2L

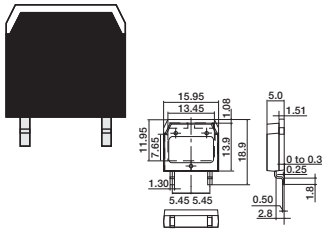

Each lead has same dimensions

Leaded type

TO-220AB

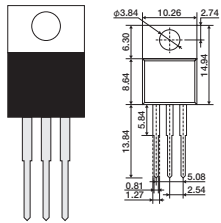

Each lead has same dimensions

TO-247

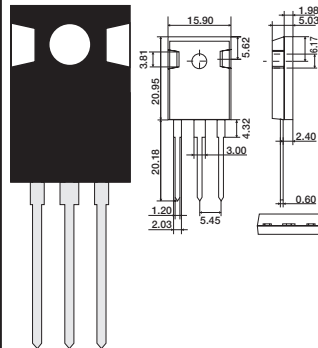

Each lead has same dimensions

TO-247N

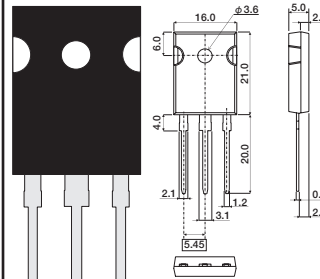

Each lead has same dimensions

TO-3PFM

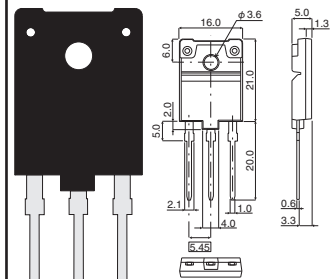

Each lead has same dimensions

Note: Package is JEDEC code.

Internal Circuit

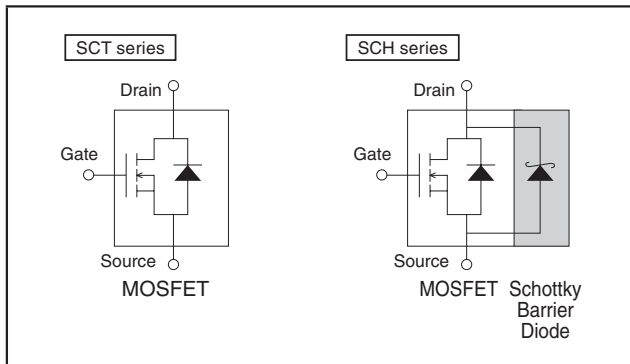

Part No. Explanation

MOSFET Part No. Explanation

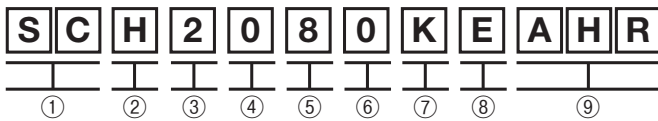

- ① SiC discrete device
- ② H → MOSFET + Schottky Barrier Diode
T → MOSFET
- ③ Generation
- ④ ON-resistance [mΩ]
- ⑤ 080 = 80mΩ
- ⑥ H12 = 1.2 Ω
- ⑦ Rated Voltage A → 650V
K → 1,200V
N → 1,700V
- ⑧ Package F → TO-220AB
E → TO-247
L → TO-247N
Y → TO-268-2L
Z → TO-3PFM
- ⑨ Automotive Grade



Packaging type

Package	Code	Packaging Style	Basic Ordering Unit(pcs)
TO-268-2L	TB	Embossed Tape	400
TO-220AB	C	Tube	50
TO-247	C	Tube	30
TO-247N	C11	Tube	30
TO-3PFM	C11	Tube	30

Full SiC Power Modules

Quick Reference for Full SiC Power Modules

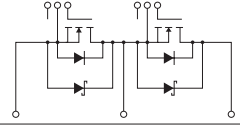
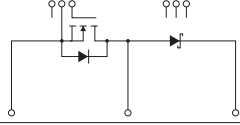
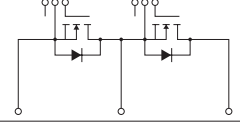
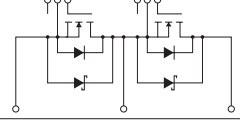
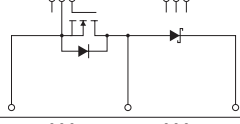
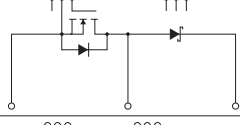
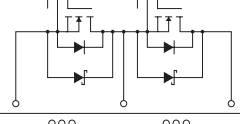
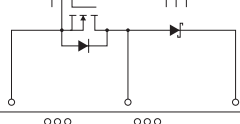
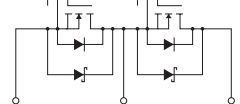
V _{DSS} (V)	R _{DS(on)} (mΩ)	Case type		
		C type	E type	G type
1,200	34	BSM080D12P2C008		
	20	New BSM120D12P2C005 BSM120C12P2C201		
	12.8	BSM180D12P2C101		
	12.2		New BSM180C12P2E202 New BSM180D12P2E002	
	10	New BSM180D12P3C007 BSM180C12P3C202		
	7.3		BSM300D12P2E001	
	6.3		New BSM300C12P2E201	
	5.3			New BSM400D12P3G002
	3.2			New BSM600D12P3G001

Full SiC Power Modules							
Part No.	Absolute Maximum Ratings (T _j = 25°C)					Package	Internal Circuit
	V _{DSS} (V)	I _D (A)	T _j (°C)	T _{stg} (°C)	Visol(V) AC 1min.		
BSM080D12P2C008	1,200	80	-40 to +175	-40 to +125	2,500	C type	
BSM120D12P2C005	1,200	120	-40 to +175	-40 to +125	2,500		
New BSM120C12P2C201	1,200	120	-40 to +175	-40 to +125	2,500		
BSM180D12P2C101	1,200	180	-40 to +175	-40 to +125	2,500		
BSM180D12P3C007	1,200	180	-40 to +175	-40 to +125	2,500		
New BSM180C12P3C202	1,200	180	-40 to +175	-40 to +125	2,500		
New BSM180C12P2E202	1,200	180	-40 to +175	-40 to +125	2,500	E type	
New BSM180D12P2E002	1,200	180	-40 to +175	-40 to +125	2,500		
BSM300D12P2E001	1,200	300	-40 to +175	-40 to +125	2,500		
New BSM300C12P3E201	1,200	300	-40 to +175	-40 to +125	2,500	G type	
New BSM400D12P3G002	1,200	400	-40 to +175	-40 to +125	2,500		
New BSM600D12P3G001	1,200	600	-40 to +175	-40 to +125	2,500		

Full SiC Power Modules

●Dimensions(Unit : mm)

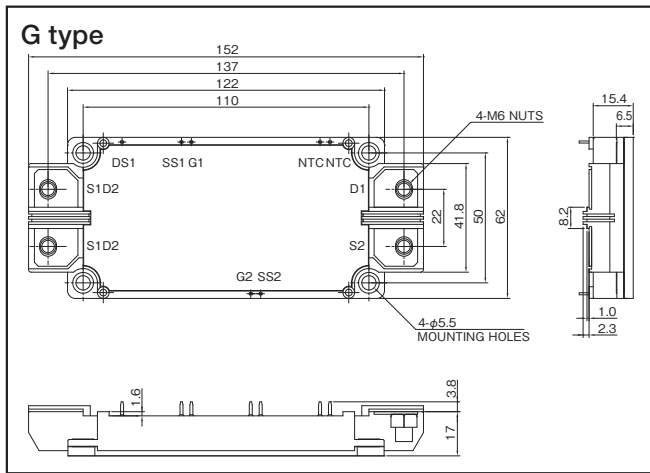
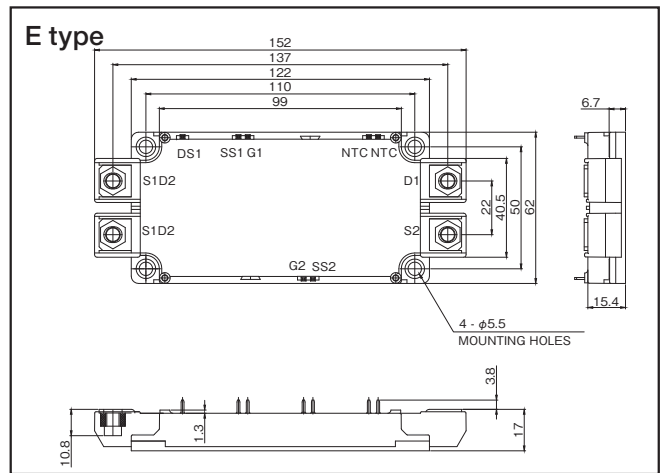
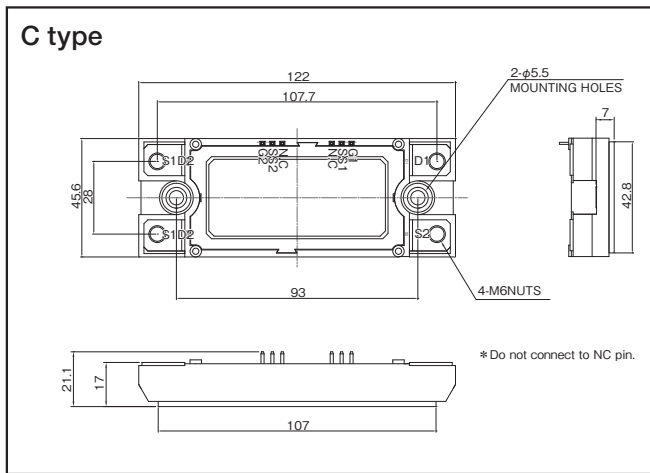

●Part No. Explanation

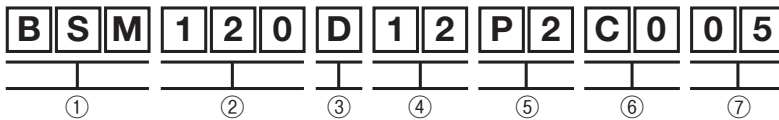

- ① SiC Power Module
- ② Rated Current
- ③ 2 in 1
- ④ Breakdown Voltage
Example 12 → 1,200V
- ⑤ Device Type
P2...2nd generation SiC MOSFET
P3...3rd generation SiC MOSFET
- ⑥ Case type
- ⑦ Additional Number



Power Devices

IGBT

CONTENTS

■ Field Stop Trench IGBT	P. B10
■ Ignition IGBT	P. B12

Field Stop Trench IGBT

● Quick Reference for Field Stop Trench IGBT Standard type

Series	V _{CES} (V) (T _C =25°C)	I _C (A) (T _C =100°C)	Package							
			TO-247N				TO-3PFM			
			IGBT Single		Built-in FRD		IGBT Single		Built-in FRD	
RGTH series (High speed switching)	650	20	RGTH40TS65	1	RGTH40TS65D	6	RGTH40TK65	11	RGTH40TK65D	16
		25	RGTH50TS65	2	RGTH50TS65D	7	RGTH50TK65	12	RGTH50TK65D	17
		30	RGTH60TS65	3	RGTH60TS65D	8	RGTH60TK65	13	RGTH60TK65D	18
		40	RGTH80TS65	4	RGTH80TS65D	9	RGTH80TK65	14	RGTH80TK65D	19
		50	RGTH00TS65	5	RGTH00TS65D	10	RGTH00TK65	15	RGTH00TK65D	20
RGCL series (Low V _{CE(sat)})	600	30	RGCL60TS60	21	RGCL60TS60D	23	RGCL60TK60	25	RGCL60TK60D	27
		40	RGCL80TS60	22	RGCL80TS60D	24	RGCL80TK60	26	RGCL80TK60D	28

SCSOA Guaranteed type

Series	V _{CES} (V) (T _C =25°C)	I _C (A) (T _C =100°C)	Package											
			TO-252	TO-263S(LPDS)/TO-262	TO-263L(LPDL)	TO-220NFM	TO-247N							
			Built-in FRD	Built-in FRD	Built-in FRD	Built-in FRD	IGBT Single	Built-in FRD						
RGT series (tsc 5μs Min.)	650	4	RGT8BM65D	29	RGT8NS65D	31	New RGT8NL65D	36						
		5					New RGT16TM65D	41						
		8	RGT16BM65D	30	RGT16NS65D	32	New RGT16NL65D	37	New RGT30TM65D	42				
		10					New RGT40TM65D	43						
		13					New RGT50TM65D	44						
		15			RGT30NS65D	33	New RGT30NL65D	38						
		20			RGT40NS65D	34	New RGT40NL65D	39				RGT40TS65D	50	
		25			RGT50NS65D	35	New RGT50NL65D	40				RGT50TS65D	51	
		30									New RGTV60TS65	45	New RGTV60TS65D	48
		40											RGT60TS65D	52
		50											RGT80TS65D	53
		80										New RGTV00TS65	46	New RGTV00TS65D
RGS series (tsc 8μs Min.)	650	30										RGS60TS65DHR	55	
		40										RGS80TS65DHR	56	
		50											RGS00TS65DHR	57
													New RGS00TS65EHR	58

Note: Package is JEDEC code. () :ROHM Packages

Field Stop Trench IGBT															
No.	Part No.	V _{CES} (V)	I _C (A)		P ₀ (W)	V _{CE(sat)} Typ.(V)	I _C (A)	t _{sc} Min. (μsec)	I _{F(Diode)} (A)		V _{F(Diode)} Typ.(V)	I _F (A)	Package	Equivalent Circuit Diagram	Automotive Grade AEC-Q101
			T _C =25°C	T _C =100°C					T _C =25°C	T _C =100°C					
1	RGTH40TS65	650	40	20	144	1.6	20	—	—	—	—	TO-247N		—	
2	RGTH50TS65	650	50	25	174	1.6	25	—	—	—	—			—	
3	RGTH60TS65	650	58	30	194	1.6	30	—	—	—	—			—	
4	RGTH80TS65	650	70	40	234	1.6	40	—	—	—	—			—	
5	RGTH00TS65	650	85	50	277	1.6	50	—	—	—	—			—	
6	RGTH40TS65D	650	40	20	144	1.6	20	—	35	20	1.45			20	—
7	RGTH50TS65D	650	50	25	174	1.6	25	—	35	20	1.45			20	—
8	RGTH60TS65D	650	58	30	194	1.6	30	—	40	20	1.35			20	—
9	RGTH80TS65D	650	70	40	234	1.6	40	—	40	20	1.35			20	—
10	RGTH00TS65D	650	85	50	277	1.6	50	—	50	30	1.45			30	—
11	RGTH40TK65	650	23	14	56	1.6	20	—	—	—	—	TO-3PFM		—	
12	RGTH50TK65	650	26	16	59	1.6	25	—	—	—	—			—	
13	RGTH60TK65	650	28	17	61	1.6	30	—	—	—	—			—	
14	RGTH80TK65	650	31	19	66	1.6	40	—	—	—	—			—	
15	RGTH00TK65	650	35	21	72	1.6	50	—	—	—	—			—	
16	RGTH40TK65D	650	23	14	56	1.6	20	—	26	15	1.45			20	—
17	RGTH50TK65D	650	26	16	59	1.6	25	—	26	15	1.45			20	—
18	RGTH60TK65D	650	28	17	61	1.6	30	—	28	16	1.35			20	—
19	RGTH80TK65D	650	31	19	66	1.6	40	—	28	16	1.35			20	—
20	RGTH00TK65D	650	35	21	72	1.6	50	—	34	19	1.45			30	—
21	RGCL60TS60	600	48	30	111	1.4	30	—	—	—	—	TO-247N		—	
22	RGCL80TS60	600	65	40	148	1.4	40	—	—	—	—			—	
23	RGCL60TS60D	600	48	30	111	1.4	30	—	35	20	1.45			20	—
24	RGCL80TS60D	600	65	40	148	1.4	40	—	35	20	1.45			20	—
25	RGCL60TK60	600	30	18	54	1.4	30	—	—	—	—	TO-3PFM		—	
26	RGCL80TK60	600	35	21	57	1.4	40	—	—	—	—			—	
27	RGCL60TK60D	600	30	18	54	1.4	30	—	26	15	1.45			20	—
28	RGCL80TK60D	600	35	21	57	1.4	40	—	26	15	1.45			20	—
29	RGT8BM65D	650	8	4	62	1.65	4	5	7	4	1.45	4	TO-252		—
30	RGT16BM65D	650	16	8	94	1.65	8	5	16	8	1.4	8			—
31	RGT8NS65D	650	8	4	65	1.65	4	5	7	4	1.45	4			—
32	RGT16NS65D	650	16	8	94	1.65	8	5	16	8	1.4	8			—
33	RGT30NS65D	650	30	15	133	1.65	15	5	26	15	1.5	15			—
34	RGT40NS65D	650	40	20	161	1.65	20	5	35	20	1.45	20			—
35	RGT50NS65D	650	48	25	194	1.65	25	5	35	20	1.45	20			—
36	New RGT8NL65D	650	8	4	65	1.65	4	5	7	4	1.45	4			—
37	New RGT16NL65D	650	16	8	94	1.65	8	5	16	8	1.4	8			—
38	New RGT30NL65D	650	30	15	133	1.65	15	5	26	15	1.5	15			—
39	New RGT40NL65D	650	40	20	161	1.65	20	5	35	20	1.45	20	—		
40	New RGT50NL65D	650	48	25	194	1.65	25	5	35	20	1.45	20	—		
41	New RGT16TM65D	650	9	5	22	1.65	8	5	13	7	1.4	8	TO-220NFM		—
42	New RGT30TM65D	650	14	8	32	1.65	15	5	17	9	1.5	15			—
43	New RGT40TM65D	650	17	10	39	1.65	20	5	22	13	1.45	20			—
44	New RGT50TM65D	650	21	13	47	1.65	25	5	22	13	1.45	20			—
45	New RGTV60TS65	650	60	30	194	1.5	30	2	—	—	—	TO-247N		—	
46	New RGTV00TS65	650	95	50	276	1.5	50	2	—	—	—			—	
47	New RGTVX6TS65	650	144	80	404	1.5	80	2	—	—	—			—	
48	New RGTV60TS65D	650	60	30	194	1.5	30	2	56	30	1.45			30	—
49	New RGTV00TS65D	650	95	50	276	1.5	50	2	84	50	1.45			50	—
50	RGT40TS65D	650	40	20	144	1.65	20	5	35	20	1.45			20	—
51	RGT50TS65D	650	48	25	174	1.65	25	5	35	20	1.45			20	—
52	RGT60TS65D	650	55	30	194	1.65	30	5	40	20	1.35			20	—
53	RGT80TS65D	650	70	40	234	1.65	40	5	40	20	1.35			20	—
54	RGT00TS65D	650	85	50	277	1.65	50	5	50	30	1.45			30	—
55	RGS60TS65DHR	650	56	30	223	1.65	30	8	56	30	1.45	30	YES		
56	RGS80TS65DHR	650	73	40	272	1.65	40	8	56	30	1.45	30	YES		
57	RGS00TS65DHR	650	88	50	326	1.65	50	8	56	30	1.45	30	YES		
58	New RGS00TS65EHR	650	88	50	326	1.65	50	8	84	50	1.45	50	YES		

Note: Package is JEDEC code. () :ROHM Packages

*Built-in Fast Recovery Diodes

Ignition IGBT

●Circuit Example for Ignition IGBT

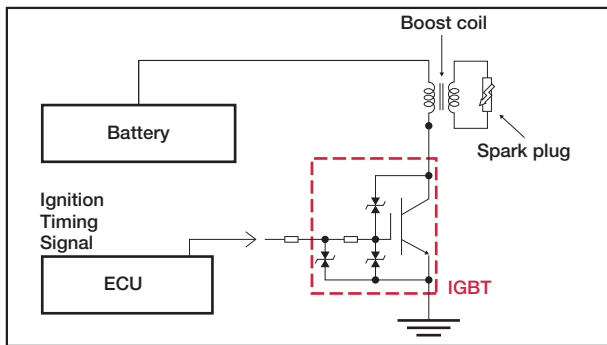

Ignition IGBT									
Part No.	V _{CEs} (V)	V _{GES} (V)	I _c (A)	P _o (W)	E _{as} (mJ)	V _{CE(sat)} Typ. (V)	Package	Equivalent Circuit Diagram	Automotive Grade AEC-Q101
RGpz10BM40FH	430±30	±10	20	107	250	1.6	TO-252		YES
☆RGpz30BM56HR	560±30	±10	30	166	300	1.4	TO-252		YES
RGPR10BM40FH	430±30	±10	20	107	250	1.6	TO-252		YES
☆RGPR20BM36HR	360±30	±10	20	107	250	1.6	TO-252		YES
RGPR20NS43HR	430±30	±10	20	107	250	1.6	TO-263S(LPDS)		YES
☆RGPR30BM56HR	560±30	±10	30	166	300	1.4	TO-252		YES
RGPR30BM40HR	400±30	±10	30	125	300	1.6	TO-252		YES
RGPR30NS40HR	400±30	±10	30	125	300	1.6	TO-263S(LPDS)		YES
☆RGPR50NS45HR	450±30	±10	45	194	500	1.6	TO-263S(LPDS)		YES

Note: Package is JEDEC code. () : ROHM Packages

☆ : Under Development

●Dimensions (Unit : mm)

TO-252

Each lead has same dimensions

TO-263S(LPDS)

Each lead has same dimensions

TO-263L(LPDL)

Each lead has same dimensions

TO-262

Each lead has same dimensions

TO-220NFM

Each lead has same dimensions

TO-247N

Each lead has same dimensions

TO-3PFM

Each lead has same dimensions

Note: Package is JEDEC code. () : ROHM Packages

●Part No. Explanation

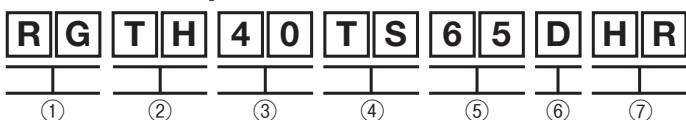

- | | | |
|--|---------------------|---------------------------------------|
| ① IGBT | ④ Package | ⑤ V _{CEs} |
| ② Series Name | ex. BM → TO-252 | ex. 65 → 650V |
| ③ I _c <T _c =100°C> | NS → TO-263S(LPDS)/ | ⑥ Fast Recovery Diodes |
| ex. 8 → 4A | TO-262 | ex. D → Built in Fast Recovery Diodes |
| 16 → 8A | NL → TO-263L(LPDL) | ⑦ Automotive Grade |
| 30 → 15A | TM → TO-220NFM | |
| 40 → 20A | TS → TO-247N | |
| 00 → 50A | TK → TO-3PFM | |

●Packaging type

Package	Code	Packaging style	Basic ordering unit(pcs)
TO-252	TL	Embossed tape	2,500
TO-263S(LPDS)	TL	Embossed tape	1,000
TO-263L(LPDL)	TL	Embossed tape	1,000
TO-262	C9	Tube	50
TO-220NFM	C9	Tube	50
TO-247N	C11	Tube	30
TO-3PFM	C11	Tube	30

Note: Package is JEDEC code. () : ROHM Packages



Power Devices

Intelligent Power Modules

CONTENTS

■ IGBT-IPM	P. B14
■ MOS-IPM	P. B14

Intelligent Power Modules

● Quick Reference for Intelligent Power Modules

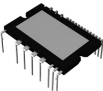
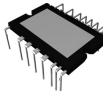
V _{DSS} /V _{CES} (V)	I _D /I _C (A)	Thermal Protective Function*2	IGBT-IPM		MOS-IPM
			PWM Input Frequency up to 6kHz	PWM Input Frequency up to 20kHz	
			 HSDIP25	 HSDIP25-VC	
600	10	TSD	BM63363S-VA BM63363S-VC	BM63763S-VA BM63763S-VC	
		VOT	New BM63563S-VA New BM63563S-VC	New BM63963S-VA New BM63963S-VC	
	15	TSD	BM63364S-VA BM63364S-VC	BM63764S-VA BM63764S-VC	BM65364S-VA BM65364S-VC
		VOT	New BM63564S-VA New BM63564S-VC	New BM63964S-VA New BM63964S-VC	
	30	TSD		BM63767S-VA BM63767S-VC	
		VOT		New BM63967S-VA New BM63967S-VC	

Intelligent Power Modules

IGBT-IPM									
Part No.	Power Device	V _{CES} (V)	I _C (A)	V _{CE(sat)} (V)	PWM Input Frequency (kHz)	Isolation Voltage*1 (Vrms)	Thermal Protective Function*2	Package	
BM63363S-VA	IGBT	600	10	1.5	up to 6	1,500	TSD	HSDIP25	
BM63363S-VC	IGBT	600	10	1.5	up to 6	1,500	TSD	HSDIP25VC	
New BM63563S-VA	IGBT	600	10	1.5	up to 6	1,500	VOT	HSDIP25	
New BM63563S-VC	IGBT	600	10	1.5	up to 6	1,500	VOT	HSDIP25VC	
BM63763S-VA	IGBT	600	10	1.7	up to 20	1,500	TSD	HSDIP25	
BM63763S-VC	IGBT	600	10	1.7	up to 20	1,500	TSD	HSDIP25VC	
New BM63963S-VA	IGBT	600	10	1.7	up to 20	1,500	VOT	HSDIP25	
New BM63963S-VC	IGBT	600	10	1.7	up to 20	1,500	VOT	HSDIP25VC	
BM63364S-VA	IGBT	600	15	1.5	up to 6	1,500	TSD	HSDIP25	
BM63364S-VC	IGBT	600	15	1.5	up to 6	1,500	TSD	HSDIP25VC	
New BM63564S-VA	IGBT	600	15	1.5	up to 6	1,500	VOT	HSDIP25	
New BM63564S-VC	IGBT	600	15	1.5	up to 6	1,500	VOT	HSDIP25VC	
BM63764S-VA	IGBT	600	15	1.7	up to 20	1,500	TSD	HSDIP25	
BM63764S-VC	IGBT	600	15	1.7	up to 20	1,500	TSD	HSDIP25VC	
New BM63964S-VA	IGBT	600	15	1.7	up to 20	1,500	VOT	HSDIP25	
New BM63964S-VC	IGBT	600	15	1.7	up to 20	1,500	VOT	HSDIP25VC	
BM63767S-VA	IGBT	600	30	1.7	up to 20	1,500	TSD	HSDIP25	
BM63767S-VC	IGBT	600	30	1.7	up to 20	1,500	TSD	HSDIP25VC	
New BM63967S-VA	IGBT	600	30	1.7	up to 20	1,500	VOT	HSDIP25	
New BM63967S-VC	IGBT	600	30	1.7	up to 20	1,500	VOT	HSDIP25VC	
MOS-IPM									
Part No.	Power Device	V _{DSS} (V)	I _D (A)	R _{on} (mΩ)	Recommended Switching Frequency (kHz)	Isolation Voltage*1 (Vrms)	Thermal Protective Function*2	Package	
BM65364S-VA	MOSFET	600	15	120	up to 20	1,500	TSD	HSDIP25	
BM65364S-VC	MOSFET	600	15	120	up to 20	1,500	TSD	HSDIP25VC	

*1 AC 60Hz, 1 minutes, Corresponds to isolation voltage 2,500Vrms in the case the convex-shaped heat sink.

*2 TSD : Thermal Shut Down, VOT : Analog Temperature Output

B Intelligent Power Modules



●Block Diagram

IGBT-IPM

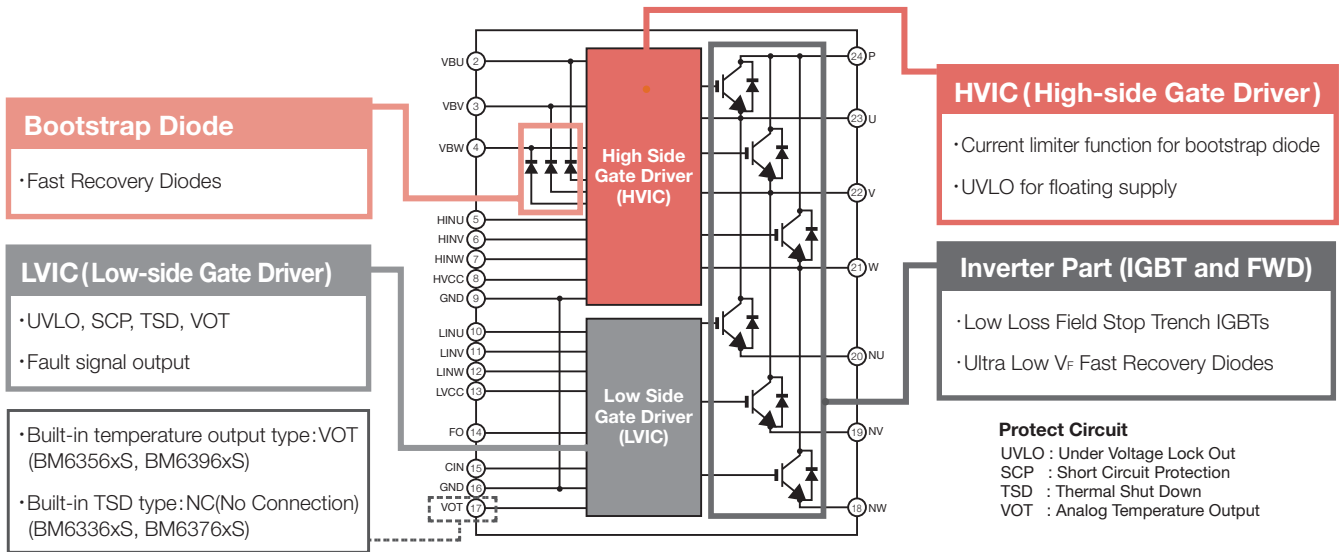

●Packages (Unit : mm)

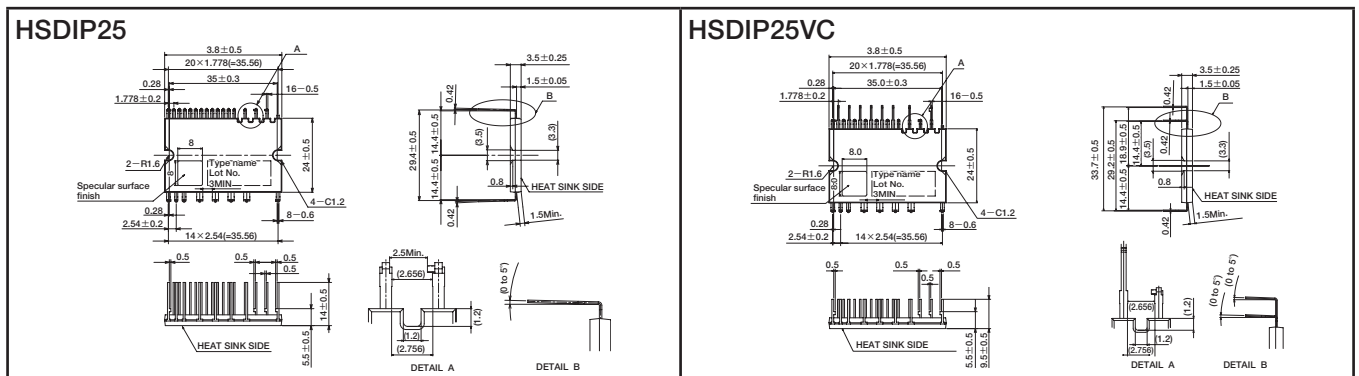

●Part No. Explanation

B M 6 3 3 6 4 S -xx

Part No.

Package

Packaging and forming specification

S	HSDIP25 HSDIP25VC
---	----------------------

VA	Tube, Long pin type(HSDIP25)
VC	Tube, Staggered type(control side)(HSDIP25VC)

B

Intelligent Power Modules



Discrete Devices

Transistors

CONTENTS

■ MOSFETs	P. C2
Small Signal MOSFETs	P. C2
Power MOSFETs	P. C10
Selector Guide for Automotive MOSFETs	P. C21
Selector Guide for Automotive Power MOSFETs	P. C22
■ Bipolar Transistors	P. C24
Bipolar Transistors	P. C24
Complex Bipolar Transistors	P. C32
■ Digital Transistors	P. C37
Digital Transistors	P. C37
Complex Digital Transistors	P. C49
■ Transistor Arrays	P. C53
■ Packages	P. C54
■ Part No. Explanation	P. C56

Small Signal MOSFETs

Quick Reference for Small Signal MOSFETs

Single type<Nch>



V _{DSS} [V]	I _D [A]										
	0.1	0.2	0.3	0.4	0.5	0.6	0.7	0.8	0.9	1	1.5
20	0.15A DFN0604-3(VML0604) / P.C3										
	0.15A DFN0806-3(VML0806) / P.C3										
	0.18A DFN1006-3(VML1006)[SC-101] / P.C3										
	1.0A										
	0.1A SOT-723(VMT3)[SC-105AA] / P.C3										
30	0.1A SOT-416FL(EMT3F)[SC-89] / P.C3										
	0.2A SOT-323FL(UMT3F)[SC-85] / P.C3										
	1.4A DFN1006-3(VML1006)[SC-101] / P.C3										
50	0.2A SOT-723(VMT3)[SC-105AA] / P.C3										
	0.2A SOT-416FL(EMT3F)[SC-89] / P.C3										
	0.2A SOT-323FL(UMT3F)[SC-85] / P.C3										
	0.2A SOT-23(SST3) / P.C3										
60	0.25A SOT-723(VMT3)[SC-105AA] / P.C3										
	0.25A SOT-416FL(EMT3F)[SC-89] / P.C3										
	0.31A 0.38A SOT-323(UMT3) / P.C3										
	0.25A SOT-323FL(UMT3F)[SC-85] / P.C3										
	0.6A SOT-23(SST3) / P.C3										
100	0.2A SOT-23(SST3) / P.C3										

Dual type<Nch+Nch>



V _{DSS} [V]	I _D [A]				
	0.1	0.2	0.3	0.4	0.5
20/20	0.1A (VMT6)[SC-105B] / P.C3				
50/50	0.2A SOT-563(EMT6)[SC-107C] / P.C3				
	0.2A SOT-363(UMT6)[SC-88] / P.C3				
60/60	0.25A SOT-563(EMT6)[SC-107C] / P.C3				
	0.25A SOT-363(UMT6)[SC-88] / P.C3				

Single type<Pch>



V _{DSS} [V]	I _D [A]										
	-0.1	-0.2	-0.3	-0.4	-0.5	-0.6	-0.7	-0.8	-0.9	-1	-1.5
-20	-0.1A DFN0604-3(VML0604) / P.C3										
	-0.1A DFN0806-3(VML0806) / P.C3										
	-0.1A DFN1006-3(VML1006)[SC-101] / P.C3										
	-1.4A										
	-0.1A SOT-723(VMT3)[SC-105AA] / P.C3										
-30	-0.1A SOT-416FL(EMT3F)[SC-89] / P.C3										
	-0.2A SOT-323FL(UMT3F)[SC-85] / P.C3										
	-1.2A DFN1006-3(VML1006)[SC-101] / P.C3										
-60	-0.2A SOT-723(VMT3)[SC-105AA] / P.C3										
	-0.25A SOT-416FL(EMT3F)[SC-89] / P.C3										
	-0.25A SOT-323FL(UMT3F)[SC-85] / P.C3										
	-0.25A SOT-23(SST3) / P.C3										
-60	-0.21A SOT-323(UMT3) / P.C3										
	-0.23A SOT-23(SST3) / P.C3										

Dual type<Pch+Pch>



V _{DSS} [V]	I _D [A]				
	-0.1	-0.2	-0.3	-0.4	-0.5
-20/-20	-0.1A (VMT6)[SC-105B] / P.C3				
-30/-30	-0.2A SOT-563(EMT6)[SC-107C] / P.C3				
	-0.2A SOT-363(UMT6)[SC-88] / P.C3				

Dual type<Nch+Pch>



V _{DSS} [V]	I _D [A]				
	-0.1	-0.2	-0.3	-0.4	-0.5
20/-20	-0.1A (VMT6)[SC-105B] / P.C3				
20/-20	-0.2A SOT-563(EMT6)[SC-107C] / P.C3				

Notes1 : Package is JEDEC code. () :ROHM Packages, [] :JEITA code
Notes2 : P.Cxx represents page number.

Small Signal MOSFETs series																				
Package	Product No.		Polarity (ch)	V _{bss} (V)	I _D (A)	P _D (W) (T _a =25°C)	R _{Ds(on)} (Ω)													
	Part No.	Taping Code					V _{GS} =10V		V _{GS} =4.5V		V _{GS} =4.0V		V _{GS} =2.5V		V _{GS} =1.8V		V _{GS} =1.5V		V _{GS} =1.2V	
			Typ.	Max.	Typ.	Max.	Typ.	Max.	Typ.	Max.	Typ.	Max.	Typ.	Max.	Typ.	Max.	Typ.	Max.	Typ.	Max.
DFN0604-3 (VML0604) • 0604 size	RV3C002UN	T2CL	N	20	0.15	0.10	—	—	1.40	2.00	—	—	1.70	2.60	—	—	2.70	5.40	—	—
	☆RV3CA01ZP*1	T2CL	P	-20	-0.10	0.10	—	—	2.50	3.80	—	—	3.40	5.10	—	—	6.00	13.20	—	—
	☆RV3C001ZP	T2CL	N	20	0.15	0.10	—	—	2.50	3.80	—	—	3.40	5.10	—	—	6.00	13.20	—	—
DFN0806-3 (VML0806) • 0806 size	RV1C002UN	T2CL	N	20	0.15	0.10	—	—	1.40	2.00	—	—	1.70	2.60	—	—	2.70	5.40	3.80	11.40
	RV1C001ZP	T2CL	P	-20	-0.10	0.10	—	—	2.50	3.80	—	—	3.40	5.10	—	—	6.00	13.20	10.00	40.00
DFN1006-3 (VML1006) [SC-101] 1006 size	RV2C0010UN	T2L	N	20	1.00	0.40	—	—	0.34	0.47	—	—	0.40	0.56	—	—	0.54	0.81	0.70	1.05
	RV2C002UN	T2L		20	0.18	0.10	—	—	1.40	2.00	—	—	1.70	2.60	—	—	2.70	5.40	3.80	11.40
	RV2E014AJ	T2CL		30	1.40*2	0.60*2	—	—	0.17	0.29	—	—	0.225	0.38	—	—	—	—	—	—
	☆RV2L009GN	T2CL	P	60	0.90*2	0.60*2	0.48	0.72	0.66	1.06	—	—	—	—	—	—	—	—	—	—
	RV2C0014BC	T2CL		-20	-1.40*2	0.60*2	—	—	0.22	0.30	—	—	0.28	0.39	0.37	0.70	—	—	—	—
	RV2C001ZP	T2L		-20	-0.10	0.10	—	—	2.50	3.80	—	—	3.40	5.10	—	—	6.00	13.20	10.00	40.00
RV2E012AT	T2CL	-30	-1.20*2	0.60*2	0.27	0.41	0.39	0.57	—	—	—	—	—	—	—	—	—	—	—	
SOT-723 (VMT3) [SC-105AA] 1212 size	RUM002N02	T2L	N	20	0.20	0.15	—	—	—	—	—	—	0.80	1.20	—	—	1.20	2.40	1.60	4.80
	RUM001L02	T2CL		20	0.10	0.15	—	—	2.50	3.50	—	—	3.00	4.20	—	—	4.50	9.00	6.00	18.00
	RYM002N05	T2CL		50	0.20	0.15	—	—	1.60	2.20	—	—	1.70	2.40	—	—	2.00	2.80	2.20	3.30
	RUM002N05	T2L	50	0.20	0.15	—	—	1.60	2.20	—	—	1.70	2.40	—	—	2.00	4.00	2.40	7.20	
	RSM002N06	T2L	60	0.25	0.15	1.70	2.40	2.10	3.00	2.30	3.20	3.00	12.00	—	—	—	—	—	—	
	RZM002P02	T2L	-20	-0.20	0.15	—	—	0.80	1.20	—	—	1.00	1.50	—	—	1.60	3.50	2.40	9.60	
	RZM001P02	T2L	-20	-0.10	0.15	—	—	2.50	3.80	—	—	3.40	5.10	—	—	6.00	13.20	10.00	40.00	
RSM002P03	T2L	-30	-0.20	0.15	0.90	1.40	1.40	2.10	1.60	2.40	—	—	—	—	—	—	—	—		
(VMT6) [SC-105B] 1212 size	VT6K1	T2CR	N+N	20	0.10	0.15	—	—	2.50	3.50	—	—	3.00	4.20	—	—	4.50	9.00	6.00	18.00
	VT6J1	T2CR	P+P	-20	-0.10	0.15	—	—	2.50	3.80	—	—	3.40	5.10	—	—	6.00	13.20	10.00	40.00
	VT6M1	T2CR	N+P	20	0.10	0.15	—	—	2.50	3.50	—	—	3.00	4.20	—	—	4.50	9.00	6.00	18.00
SOT-416FL (EMT3F) [SC-89] 1616 size	RE1C002UN	TCL	N	20	0.20	0.15	—	—	—	—	—	—	0.80	1.20	—	—	1.20	2.40	1.60	4.80
	RE1C001UN	TCL		20	0.10	0.15	—	—	2.50	3.50	—	—	3.00	4.20	—	—	4.50	9.00	6.00	18.00
	RE1J002YN	TCL		50	0.20	0.15	—	—	1.60	2.20	—	—	1.70	2.40	—	—	2.00	2.80	2.20	3.30
	RE1L002SN	TL	60	0.25	0.15	1.70	2.40	2.10	3.00	2.30	3.20	3.00	12.00	—	—	—	—	—	—	
	RE1C002ZP	TL	-20	-0.20	0.15	—	—	0.80	1.20	—	—	1.00	1.50	—	—	1.60	3.50	2.40	9.60	
	RE1C001ZP	TL	-20	-0.10	0.15	—	—	2.50	3.80	—	—	3.40	5.10	—	—	6.00	13.20	10.00	40.00	
RE1E002SP	TCL	-30	-0.25	0.15	0.90	1.40	1.40	2.10	1.60	2.40	—	—	—	—	—	—	—	—		
SOT-563 (EMT6) [SC-107C] 1616 size	EM6K6	T2R	N+N	20	0.30	0.15	—	—	—	—	0.70	1.00	0.80	1.20	1.00	1.40	—	—	—	—
	EM6K7	T2CR		20	0.20	0.15	—	—	—	—	—	—	0.80	1.20	—	—	1.20	2.40	1.60	4.80
	EM6K33	T2R		50	0.20	0.15	—	—	1.60	2.20	—	—	1.70	2.40	—	—	2.00	4.00	2.40	7.20
	EM6K34	T2CR	50	0.20	0.15	—	—	1.60	2.20	—	—	1.70	2.40	—	—	2.00	2.80	2.20	3.30	
	EM6K31	T2R	60	0.25	0.15	1.70	2.40	2.10	3.00	2.30	3.20	3.00	12.00	—	—	—	—	—	—	
	EM6J1	T2R	P+P	-20	-0.20	0.15	—	—	0.80	1.20	—	—	1.00	1.50	—	—	1.60	3.50	2.40	9.60
	EM6M2	T2R	N+P	20	0.20	0.15	—	—	—	—	0.70	1.00	0.80	1.20	1.00	1.40	1.20	2.40	1.60	4.80
SOT-323 (UMT3) 2021 size	☆BSS138W	T106	N	60	0.31	0.30	1.70	2.40	2.10	3.00	—	—	3.00	12.00	—	—	—	—	—	
☆BSS138BKW	T106	60		0.38	0.30	0.50	0.70	0.60	0.84	—	—	—	1.00	4.00	—	—	—	—		
☆BSS84W	T106	P		-60	-0.21	0.30	3.60	5.30	4.30	6.40	—	—	—	—	—	—	—	—		
SOT-323FL (UMT3F) [SC-85] 2021 size	RU1C002UN	TCL	N	20	0.20	0.15	—	—	—	—	—	—	0.80	1.20	—	—	1.20	2.40	1.60	4.80
	RU1C001UN	TCL		20	0.10	0.20	—	—	2.50	3.50	—	—	3.00	4.20	—	—	4.50	9.00	6.00	18.00
	RU1J002YN	TCL		50	0.20	0.15	—	—	1.60	2.20	—	—	1.70	2.40	—	—	2.00	2.80	2.20	3.30
	RU1L002SN	TL	60	0.25	0.20	1.70	2.40	2.00	3.00	2.30	3.20	3.00	12.00	—	—	—	—	—	—	
	RU1C002ZP	TCL	-20	-0.20	0.15	—	—	0.80	1.20	—	—	1.00	1.50	—	—	1.60	3.50	2.40	9.60	
	RU1C001ZP	TL	-20	-0.10	0.20	—	—	2.50	3.80	—	—	3.40	5.10	—	—	6.00	13.20	10.00	40.00	
RU1E002SP	TCL	-30	-0.25	0.20	0.90	1.40	1.40	2.10	1.60	2.40	—	—	—	—	—	—	—	—		
SOT-363 (UMT6) [SC-88] 2021 size	UM6K34N	TCN	N+N	50	0.20	0.15	—	—	1.60	2.20	—	—	1.70	2.40	—	—	2.00	2.80	2.20	3.30
	UM6K33N	TN		50	0.20	0.15	—	—	1.60	2.20	—	—	1.70	2.40	—	—	2.00	4.00	2.40	7.20
	UM6K31N	TN	60	0.25	0.15	1.70	2.40	2.10	3.00	2.30	3.20	3.00	12.00	—	—	—	—	—	—	
	UM6J1N	TN	P+P	-30	-0.20	0.15	0.90	1.40	1.40	2.10	1.60	2.40	—	—	—	—	—	—	—	
SOT-23 (SST3) 2924 size	RYC002N05	T316	N	50	0.20	0.20	—	—	1.60	2.20	—	—	1.70	2.40	—	—	2.00	2.80	2.20	3.30
	RUC002N05	T116		50	0.20	0.20	—	—	1.60	2.20	—	—	1.70	2.40	—	—	2.00	4.00	2.40	7.20
	New BSS670	T116		60	0.60	0.35	0.50	0.65	0.60	0.82	—	—	1.00	4.00	—	—	—	—	—	
	New BSS138BK	T116	60	0.40	0.35	0.50	0.70	0.60	0.84	—	—	1.00	4.00	—	—	—	—	—	—	
	☆RK7002BM	T116	60	0.25	0.20	1.70	2.40	2.10	3.00	2.30	3.20	3.00	12.00	—	—	—	—	—		
	☆BSS123	T116	100	0.20	0.35	5.50	7.70	5.90	8.20	—	—	—	—	—	—	—	—	—		
	☆RSC002P03	T316	P	-30	-0.25	0.20	0.90	1.40	1.40	2.10	1.60	2.40	—	—	—	—	—	—	—	
New BSS84	T116	-60		-0.23	0.35	3.60	5.30	4.30	6.40	—	—	—	—	—	—	—	—	—		

Notes1 : Package is JEDEC code. () :ROHM Packages, [] :JEITA code
Notes2 : *1: For overvoltage protection *2: PW ≤ 5s

☆: Under Development

Small Signal MOSFETs

Quick Reference for Small Signal MOSFETs

Single type<Nch>

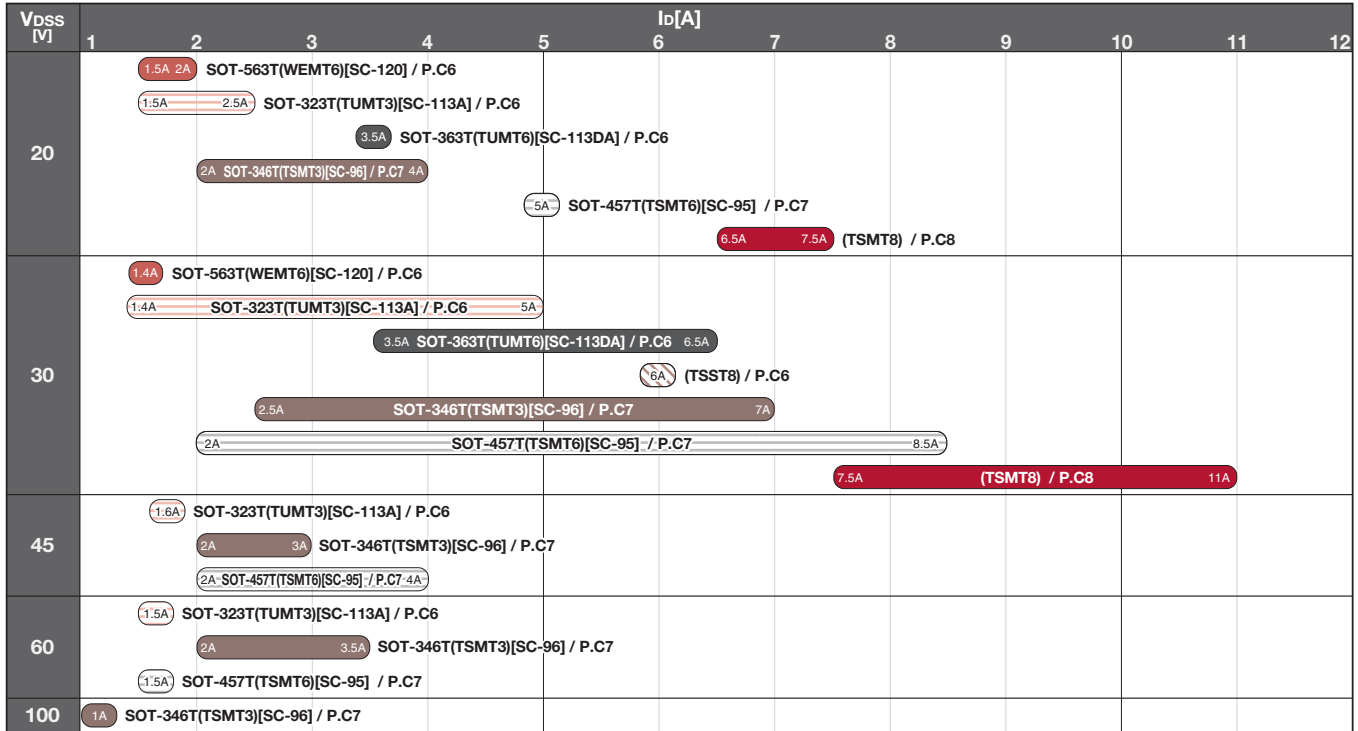

Single type<Pch>

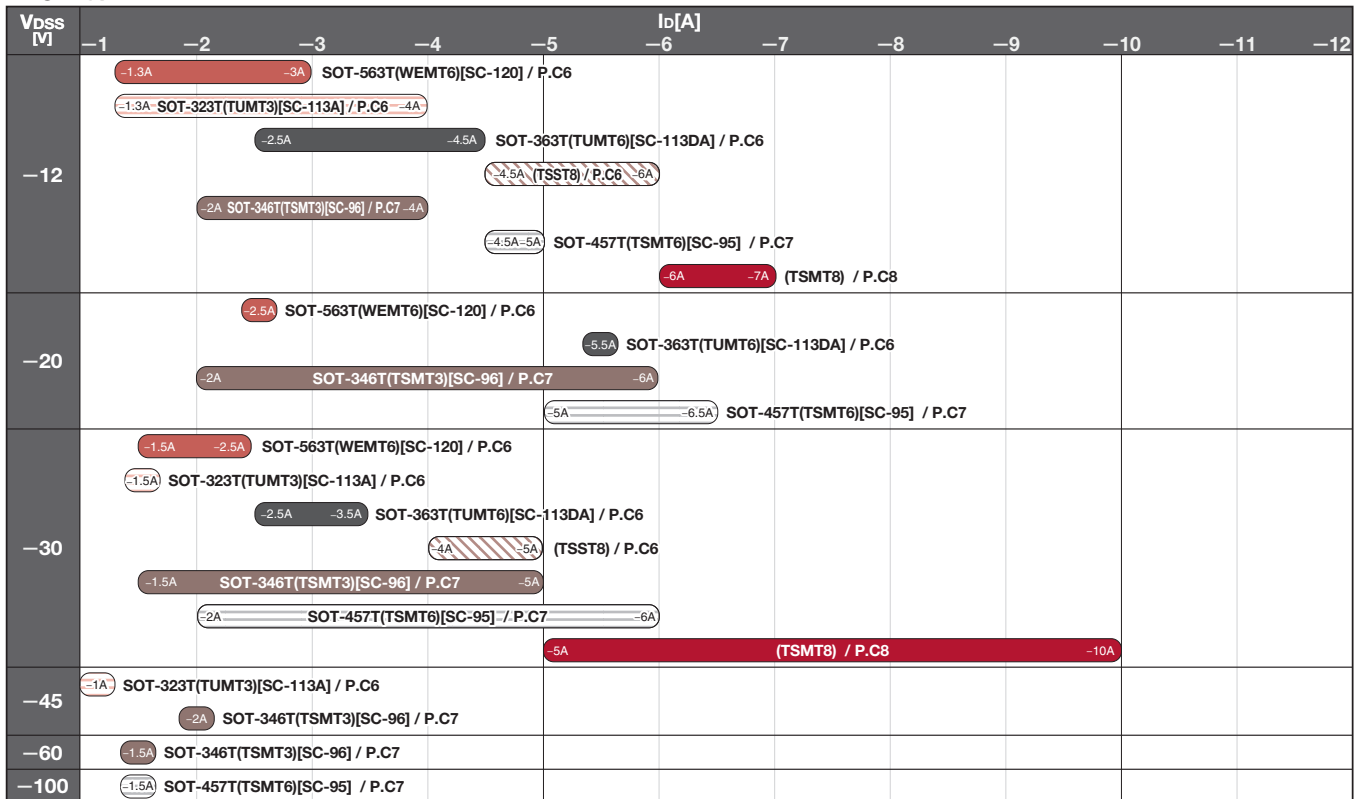

Notes1 : Package is JEDEC code. ():ROHM Packages, []:JEITA code
Notes2 : P.Cxx represents page number.

Quick Reference for Small Signal MOSFETs

Dual type<Nch+Nch>



V _{DSS} [V]	1	2	3	4	5	6	7	8	9	10
20/20	1.5A SOT-363T(TUMT6)[SC-113DA] / P.C6	2.5A (TSST8) / P.C6								
30/30	1.4A 1.5A SOT-363T(TUMT6)[SC-113DA] / P.C6	2A SOT-25T(TSMT5) / P.C7	2.5A 3.0A (TSST8) / P.C6							
40/40										
45/45	1A SOT-457T(TSMT6)[SC-95] / P.C7									
100/100		2A (TSMT8) / P.C8								

Dual type<Pch+Pch>

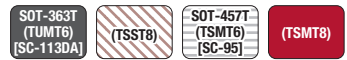

V _{DSS} [V]	-1	-2	-3	-4	-5	-6	-7	-8	-9	-10
-12/-12	-1.3A -2A SOT-363T(TUMT6)[SC-113DA] / P.C6	-2.5A (TSST8) / P.C6	-3.5A (TSST8) / P.C6							
-20/-20	-1.5A SOT-457T(TSMT6)[SC-95] / P.C7									
-30/-30										

Dual type<Nch+Pch>



V _{DSS} [V]	1	2	3	4	5	6	7	8	9	10
20/-12	1.3A 1.5A SOT-363T(TUMT6)[SC-113DA] / P.C6									
20/-20										
30/-20	1A 1.5A SOT-363T(TUMT6)[SC-113DA] / P.C6									
30/-30										
40/-40										
60/-60										
100/-100										

Notes1 : Package is JEDEC code. () :ROHM Packages, [] :JEITA code
Notes2 : P.Cxx represents page number.



Small Signal MOSFETs

Small Signal MOSFETs series																		
Package	Product No.		Polarity (ch)	V _{DSS} (V)	I _D (A)	P _D (W) (Ta=25°C)	R _{DS(on)} (mΩ)								Qg(nC) (V _{GS} =4.5)			
	Part No.	Taping Code					V _{GS} =10V		V _{GS} =4.5V		V _{GS} =4.0V		V _{GS} =2.5V			V _{GS} =1.5V		
							Typ.	Max.	Typ.	Max.	Typ.	Max.	Typ.	Max.		Typ.	Max.	
SOT-563T (WEMT6) [SC-120] 1616 size	RW1C020UN	T2R	N	20	2	0.7	—	—	75	105	—	—	95	135	170	240	2	
	RW1C015UN	T2R		20	1.5	0.7	—	—	130	180	—	—	170	240	300	600	1.8	
	RW1E014SN	T2R		30	1.4	0.7	170	240	250	350	270	380	—	—	—	—	1.4* ²	
	RW1A030AP	T2CR		-12	-3	0.7	—	—	30	42	—	—	40	56	75	150	22	
	RW1A025AP	T2R		-12	-2.5	0.7	—	—	44	62	—	—	55	77	90	180	16	
	RW1A020ZP	T2R		-12	-2	0.7	—	—	75	105	—	—	105	145	200	400	6.5	
	RW1A013ZP	T2R		-12	-1.3	0.7	—	—	190	260	—	—	280	390	530	1060	2.4	
	RW1C025ZP	T2CR		-20	-2.5	0.7	—	—	48	65	—	—	65	90	120	240	10.5	
	RW1E025RP	T2R		-30	-2.5	0.7	55	75	85	115	95	125	—	—	—	—	5.2* ²	
RW1E015RP	T2R	-30	-1.5	0.7	115	160	170	240	190	270	—	—	—	—	5.2* ²			
SOT-323T (TUMT3) [SC-113A] 2021 size	RUF025N02	TL	N	20	2.5	0.8	—	—	39	54	—	—	49	68	80	160	5	
	RUF020N02	TL		20	2	0.8	—	—	75	105	—	—	95	135	170	240	2	
	RUF015N02	TL		20	1.5	0.8	—	—	130	180	—	—	170	240	220* ¹	310* ¹	1.8	
	☆RF5E050AJ	TCL		30	5	0.8	—	—	16.7	21.8	—	—	24	31.3	—	—	7.6	
	RTF025N03	TL		30	2.5	0.8	—	—	48	67	50	70	70	98	—	—	3.7	
	RSF014N03	TL		30	1.4	0.8	170	240	250	350	270	380	—	—	—	—	1.4* ²	
	RTF016N05	TL		45	1.6	0.8	—	—	140	190	150	210	200	280	—	—	2.3	
	RSF015N06	TL		60	1.5	0.8	210	290	240	330	255	350	—	—	—	—	2* ²	
	RAF040P01	TCL		-12	-4	0.8	—	—	22	30	—	—	27	38	40	68	37	
	RZF030P01	TL		-12	-3	0.8	—	—	28	39	—	—	39	54	72	144	18	
	RZF020P01	TL		-12	-2	0.8	—	—	75	105	—	—	105	145	200	400	6.5	
	RZF013P01	TL		-12	-1.3	0.8	—	—	190	260	—	—	280	390	530	1060	2.4	
	RRF015P03	TL		-30	-1.5	0.8	115	160	170	240	190	270	—	—	—	—	3.2* ²	
	RSF010P05	TL		-45	-1	0.8	330	460	450	630	490	690	—	—	—	—	2.3* ²	
SOT-363T (TUMT6) [SC-113DA] 2021 size	RUL035N02	TR	N	20	3.5	1	—	—	31	43	—	—	38	53	66	93	5.7	
	RF6E065BN	TCR		30	6.5	1	12.9	15.3	18.5	22.7	—	—	—	—	—	—	8.3	
	RF6E045AJ	TR		30	4.5	1	—	—	16.9	23.7	—	—	23.9	33.5	—	—	8.1	
	RTL035N03	TR		30	3.5	1	—	—	40	56	42	59	56	79	—	—	4.6	
	RXL035N03	TCR		30	3.5	1	35	50	45	65	50	70	—	—	—	—	3.3* ²	
	US6K4	TR		N+N	20	1.5	1	—	—	130	180	—	—	170	240	220* ¹	310* ¹	1.8
	US6K1	TR			30	1.5	1	—	—	170	240	180	250	240	340	—	—	1.6
	US6K2	TR			30	1.4	1	170	240	250	350	270	380	—	—	—	—	1.4* ²
	RAL045P01	TCR			-12	-4.5	1	—	—	22	30	—	—	28	39	50	100	40
	RAL035P01	TR		P	-12	-3.5	1	—	—	30	42	—	—	40	56	75	150	22
	RAL025P01	TR			-12	-2.5	1	—	—	44	62	—	—	55	77	90	180	16
	RF6C055BC	TCR			-20	-5.5	1	—	—	19.5	25.7	—	—	24.7	33.1	33.7	63.6	15.2
	RRL035P03	TR			-30	-3.5	1	36	50	52	72	58	81	—	—	—	—	8* ²
	RRL025P03	TR		-30	-2.5	1	55	75	85	115	95	125	—	—	—	—	5.2* ²	
	US6J12	TCR		P+P	-12	-2	1	—	—	75	105	—	—	105	145	200	400	7.6
	US6J11	TR			-12	-1.3	1	—	—	190	260	—	—	280	390	530	1060	2.4
	US6M11	TR		N+P	20	1.5	1	—	—	130	180	—	—	170	240	300	600	1.8
					-12	-1.3	1	—	—	190	260	—	—	280	390	530	1060	2.4
		30			1.5	1	—	—	170	240	180	250	240	340	—	—	—	1.6
		-20			-1	1	—	—	280	390	310	430	570	800	—	—	—	2.1
US6M1	TR	N+P	30	1.4	1	170	240	250	350	270	380	—	—	—	—	1.4* ²		
-20	-1		1	—	—	280	390	310	430	570	800	—	—	—	2.1			
(TSST8) 3019 size	RT1E060XN	TR	N	30	6	1.25	16	22	21	29	23	32	—	—	—	—	6.8* ²	
	TT8K1	TR		20	2.5	1.25	—	—	52	72	—	—	65	90	100	140	3.6	
	TT8K11	TR		N+N	30	3	1.25	51	71	67	94	78	109	—	—	—	—	2.5* ²
	TT8K2	TR			30	2.5	1.25	—	—	65	90	70	95	95	130	—	—	3.2
	RT1A060AP	TR			-12	-6	1.25	—	—	14	19	—	—	17	24	27	54	80
	RT1A050ZP	TR		P	-12	-5	1.25	—	—	19	26	—	—	26	36	48	96	34
	RT1A045AP	TR			-12	-4.5	1.25	—	—	22	30	—	—	28	39	50	100	40
	RT1E050RP	TR			-30	-5	1.25	26	36	36	50	40	56	—	—	—	—	13* ²
	RT1E040RP	TR			-30	-4	1.25	32	45	45	63	52	72	—	—	—	—	10.5
	TT8J11	TR		P+P	-12	-3.5	1.25	—	—	31	43	—	—	43	60	80	160	22
	TT8J13	TR			-12	-2.5	1.25	—	—	44	62	—	—	55	77	90	180	16
	TT8J21	TR			-20	-2.5	1.25	—	—	49	68	—	—	68	95	140	280	12
	TT8J2	TR			-30	-2.5	1.25	60	84	95	130	115	160	—	—	—	—	4.8* ²
	TT8J3	TR		-30	-2.5	1.25	65	84	100	130	120	160	—	—	—	—	4.8* ²	
	TT8M1	TR		N+P	20	2.5	1.25	—	—	52	72	—	—	65	90	100	140	3.6
					-20	-2.5	1.25	—	—	49	68	—	—	68	95	140	280	12
					20	2.5	1.25	—	—	52	72	—	—	65	90	100	140	3.6
		-20			-2.4	1.25	—	—	80	105	—	—	105	140	180	360	6.7	
		30			2.5	1.25	—	—	65	90	70	95	95	130	—	—	—	3.2
		-20			-2.5	1.25	—	—	49	68	—	—	68	95	140	280	12	
		TT8M11			TCR	30	3	1.25	51	71	67	94	78	109	—	—	—	—
-30	-2.5	1.25	60	84	95	130	115	160	—	—	—	—	—	4.8* ²				

Notes1 : Package is JEDEC code. ():ROHM Packages, []:JEITA code
Notes2 : *1: V_{GS}=1.8V *2: V_{GS}=5V

☆: Under Development

C Transistors

Small Signal MOSFETs series																					
Package	Product No.		Polarity (ch)	V _{bss} (V)	I _D (A)	P _D (W) (Ta=25°C)	R _{DS(on)} (mΩ)										Q _g (nC) (V _{GS} =4.5V)				
	Part No.	Taping Code					V _{GS} =10V		V _{GS} =4.5V		V _{GS} =2.5V		V _{GS} =1.8V		V _{GS} =1.5V						
							Typ.	Max.	Typ.	Max.	Typ.	Max.	Typ.	Max.	Typ.	Max.					
SOT-346T (TSMT3) [SC-96] 2928 size 	RUR040N02	TL	N	20	4	1	—	—	25	35	—	—	33	46	42	59	55	110	8		
	RUR020N02	TL		20	2	1	—	—	75	105	—	—	95	135	130	185	170	240	2		
	RQ5E070BN	TCL		30	7	1	12.4	16.1	16.5	20.4	—	—	—	—	—	—	—	—	—	11.7	
	New RQ5E065AJ	TCL		30	6.5	1	—	—	13.7	18.1	—	—	17.9	23.7	—	—	—	—	—	—	12.2
	New RQ5E040TN	TL		30	4	1	—	—	34	48	36	50	47	66	—	—	—	—	—	—	5.9
	RQ5E040AJ	TCL		30	4	1	—	—	27	37	—	—	39	54	—	—	—	—	—	—	4.3
	New RQ5E035XN	TCL		30	3.5	1	35	50	45	65	50	70	—	—	—	—	—	—	—	—	3.3*1
	RQ5E035BN	TCL		30	3.5	1	28	37	43	56	—	—	—	—	—	—	—	—	—	—	3.1
	RQ5E030AJ	TCL		30	3	1	—	—	57	75	—	—	81	109	—	—	—	—	—	—	2.1
	New RQ5E025SN	TL		30	2.5	1	50	70	74	105	83	118	—	—	—	—	—	—	—	—	2.9*1
	New RQ5E025TN	TL		30	2.5	1	—	—	66	92	70	98	95	133	—	—	—	—	—	—	3.3
	New RQ5H030TN	TL		45	3	1	—	—	48	67	53	74	68	95	—	—	—	—	—	—	6.2
	New RQ5H025TN	TL		45	2.5	1	—	—	95	130	100	140	125	175	—	—	—	—	—	—	3.2
	RSR025N05	TL		45	2.5	1	70	100	95	150	105	160	—	—	—	—	—	—	—	—	3.6*1
	New RQ5H020TN	TL		45	2	1	—	—	130	180	135	190	180	250	—	—	—	—	—	—	2.9
	New RQ5L035GN	TCL		60	3.5	1	38	51	53	72	—	—	—	—	—	—	—	—	—	—	3.8
	New RQ5L030SN	TL		60	3	1	60	85	70	100	75	105	—	—	—	—	—	—	—	—	5*1
	New RQ5L020SN	TL		60	2	1	120	170	140	195	150	210	—	—	—	—	—	—	—	—	2.7*1
	New RQ5P010SN	TL		100	1	1	370	520	400	560	410	580	—	—	—	—	—	—	—	—	3.5*1
	RQ5A040ZP	TL		P	-12	-4	1	—	—	22	30	—	—	30	42	40	60	55	110	30	
	RQ5A030AP	TL			-12	-3	1	—	—	44	62	—	—	55	77	75	110	90	180	16	
	New RQ5A025ZP	TL			-12	-2.5	1	—	—	44	61	—	—	60	84	81	121	110	220	13	
	New RQ5A020ZP	TL			-12	-2	1	—	—	75	105	—	—	105	145	150	225	200	400	6.5	
	RQ5C060BC	TCL			-20	-6	1	—	—	16.1	21.1	—	—	20.3	26.9	27.4	51.0	—	—	—	19.2
	RQ5C035BC	TCL			-20	-3.5	1	—	—	42	59	—	—	54	76	84	135	—	—	—	6.5
	New RQ5C030TP	TL			-20	-3	1	—	—	55	75	60	85	90	125	—	—	—	—	—	9.3
	New RQ5C025TP	TL			-20	-2.5	1	—	—	70	95	75	105	115	160	—	—	—	—	—	7
	New RQ5C020TP	TL			-20	-2	1	—	—	100	135	110	150	180	250	—	—	—	—	—	4.9
	RQ5E050AT	TCL			-30	-5	1	21	26	30	37	—	—	—	—	—	—	—	—	—	9.7
	RQ5E040RP	TL			-30	-4	1	32	45	45	63	52	72	—	—	—	—	—	—	—	10.5*1
	RQ5E035AT	TCL			-30	-3.5	1	38	50	54	70	—	—	—	—	—	—	—	—	—	5.2
New RQ5E030RP	TL	-30	-3		1	55	75	85	115	95	125	—	—	—	—	—	—	—	5.2*1		
New RQ5E025SP	TL	-30	-2.5		1	70	98	100	140	115	160	—	—	—	—	—	—	—	5.4*1		
RQ5E025AT	TCL	-30	-2.5		1	70	91	104	135	—	—	—	—	—	—	—	—	—	4.7		
New RQ5E020SP	TL	-30	-2		1	85	120	135	190	150	210	—	—	—	—	—	—	—	4.3*1		
New RQ5E015RP	TL	-30	-1.5		1	115	160	170	240	190	270	—	—	—	—	—	—	—	3.2*1		
RQ5H020SP	TL	-45	-2		1	130	190	180	260	200	280	—	—	—	—	—	—	—	9.5*2		
RQ5L015SP	TL	-60	-1.5		1	200	280	240	340	255	360	—	—	—	—	—	—	—	10*2		
SOT-25T (TSMT5) 2928 size 	QS5K2	TR	N+N		30	2	1.25	—	—	71	100	76	107	110	154	—	—	—	—	2.8	
SOT-457T (TSMT6) [SC-95] 2928 size 	RQ6C050UN	TR	N		20	5	1.25	—	—	22	30	—	—	27	38	32	45	40	80	12	
	RQ6E085BN	TCR			30	8.5	1.25	11.1	14.4	13.9	17.3	—	—	—	—	—	—	—	—	—	16.6
	New RQ6E080AJ	TCR			30	8	1.25	—	—	12.5	16.5	—	—	15.7	19.5	—	—	—	—	—	16.2
	RQ6E055BN	TR			30	5.5	1.25	19	25	30	39	—	—	—	—	—	—	—	—	—	4.4
	New RQ6E050AJ	TCR			30	5	1.25	—	—	26	35	—	—	38	50	—	—	—	—	—	4.7
	RQ6E045BN	TCR			30	4.5	1.25	21	30	35	49	—	—	—	—	—	—	—	—	—	4.7
	New RQ6E045TN	TR			30	4.5	1.25	—	—	30	43	32	45	42	60	—	—	—	—	—	7.6
	New RQ6E045SN	TR			30	4.5	1.25	27	38	36	51	40	56	—	—	—	—	—	—	—	6.8*1
	New RQ6E040XN	TCR			30	4	1.25	35	50	45	65	50	70	—	—	—	—	—	—	—	33*1
	New RQ6E035TN	TR			30	3.5	1.25	—	—	38	54	40	56	55	77	—	—	—	—	—	4.6
	RSQ020N03	TR			30	2	1.25	96	134	148	207	168	235	—	—	—	—	—	—	—	2.2*1
	RTQ020N03	TR		30	2	1.25	—	—	89	125	94	132	138	194	—	—	—	—	—	2.4	
	RVQ040N05	TR		45	4	1.25	38	53	47	66	53	74	—	—	—	—	—	—	—	6.3*1	
	RTQ020N05	TR		45	2	1.25	—	—	140	190	150	210	200	280	—	—	—	—	—	2.3	
	RSQ015N06	TR		60	1.5	1.25	210	290	240	330	255	350	—	—	—	—	—	—	—	2*1	
	QS6K1	TR		N+N	30	1	1.25	—	—	170	238	180	252	260	364	—	—	—	—	—	1.7
	New QH6K21	TR			45	1	1.25	—	—	300	420	310	435	415	585	—	—	—	—	—	1.5
	New RQ6A050ZP	TR			-12	-5	1.25	—	—	19	26	—	—	26	36	33	49	44	88	35	
	New RQ6A045AP	TCR			-12	-4.5	1.25	—	—	22	30	—	—	28	39	38	57	50	100	40	
	New RQ6A045ZP	TR			-12	-4.5	1.25	—	—	25	35	—	—	31	43	39	58	50	100	31	
	New RQ6C065BC	TCR			-20	-6.5	1.25	—	—	14.9	21	—	—	18.6	26	25	50	—	—	—	22
	RQ6C050BC	TCR			-20	-5	1.25	—	—	27	36	—	—	35	47	48	77	—	—	—	10.4
	RQ6E060AT	TCR			-30	-6	1.25	20.3	26.4	26.8	34.6	—	—	—	—	—	—	—	—	—	12.9
	RQ6E050AT	TCR			-30	-5	1.25	21	27	29	38	—	—	—	—	—	—	—	—	—	10.4
	New RQ6E045RP	TR			-30	-4.5	1.25	25	35	34	48	38	53	—	—	—	—	—	—	—	14*1
	RQ6E035AT	TCR			-30	-3.5	1.25	38	50	54	70	—	—	—	—	—	—	—	—	—	5.2
	New RQ6E035SP	TR		-30	-3.5	1.25	45	65	65	90	70	95	—	—	—	—	—	—	—	9.2*1	
	RQ6E030AT	TCR		-30	-3	1.25	70	91	104	135	—	—	—	—	—	—	—	—	—	2.7	
	New RQ6E030SP	TR		-30	-3	1.25	60	80	90	125	100	140	—	—	—	—	—	—	—	6*1	
	RRQ020P03	TR		-30	-2	1.25	115	160	170	240	190	270	—	—	—	—	—	—	—	3.2*1	
	RQ6P015SP	TR		-100	-1.5	1.25	350	470	380	510	400	540	—	—	—	—	—	—	—	17*1	
	QS6J11	TR		P+P	-12	-2	1.25	—	—	75	105	—	—	105	145	150	225	200	400	6.5	
	New QH6J1	TR			-20	-1.5	1.25	—	—	155	215	170									

Small Signal MOSFETs

Small Signal MOSFETs series																				
Package	Product No.		Polarity (ch)	V _{DSS} (V)	I _D (A)	P _D (W) (Ta=25°C)	R _{DS(on)} (mΩ)										Qg(nC) (VGS=4.5V)			
	Part No.	Taping Code					V _{GS} =10V		V _{GS} =4.5V		V _{GS} =4.0V		V _{GS} =2.5V		V _{GS} =1.8V			V _{GS} =1.5V		
							Typ.	Max.	Typ.	Max.	Typ.	Max.	Typ.	Max.	Typ.	Max.		Typ.	Max.	
(TSMT8) 3028 size 	RQ1C075UN	TR	N	20	7.5	1.5	—	—	11	16	—	—	14	20	17	24	20	40	18	
	RQ1C065UN	TR		20	6.5	1.5	—	—	16	22	—	—	19	27	24	32	29	58	11	
	RQ7E110AJ	TCR		30	11	1.5	—	—	6.8	9	—	—	9.1	12.4	—	—	—	—	—	22
	RQ1E100XN	TR		30	10	1.5	7.5	10.5	9.5	13.3	10	14	—	—	—	—	—	—	—	12.7*1
	RQ1E075XN	TCR		30	7.5	1.5	12	17	17	24	19	27	—	—	—	—	—	—	—	6.8*1
	QH8KA4	TCR		30	9	1.5	—	—	12.5	17	13	18	17	24	—	—	—	—	—	12
	QS8K13	TCR	30	6	1.5	20	28	25	35	28	39	—	—	—	—	—	—	—	5.5*1	
	QH8KA2	TR	30	4.5	1.5	25	35	40	56	—	—	—	—	—	—	—	—	—	4.7	
	QH8KA1	TCR	30	4.5*2	2.4*2	56	73	86	112	—	—	—	—	—	—	—	—	—	1.5	
	QS8K11	TR	30	3.5	1.5	35	50	45	65	50	70	—	—	—	—	—	—	—	3.3*1	
	New QH8K26	TR	40	7*2	2.6*2	27	38	35	50	—	—	—	—	—	—	—	—	—	2.9*1	
	New QH8K22	TCR	40	6*2	2.5*2	34.6	46	43.9	59	—	—	—	—	—	—	—	—	—	1.3	
	QS8K21	TR	45	4	1.5	38	53	48	67	53	75	—	—	—	—	—	—	—	5.4*1	
	New QH8K51	TR	100	2	1.5	240	325	250	340	260	355	—	—	—	—	—	—	—	4.7*1	
	RQ1A070AP	TR	-12	-7	1.5	—	—	10	14	—	—	13	19	18	27	24	48	80	8	
	RQ1A060ZP	TR	-12	-6	1.5	—	—	16	23	—	—	22	31	28	42	39	78	34	—	
	☆RQ7E100AT	TCR	-30	-10	1.5	8.7	10.6	11.9	14.8	—	—	—	—	—	—	—	—	—	26	
	RQ1E070RP	TR	-30	-7	1.5	12	17	17	24	19	27	—	—	—	—	—	—	—	26*1	
	RQ7E055AT	TCR	-30	-5.5	1.5	19.3	24.5	28.2	36.1	—	—	—	—	—	—	—	—	—	9.4	
	RQ1E050RP	TR	-30	-5	1.5	22	31	32	45	36	50	—	—	—	—	—	—	—	13*1	
	QS8J13	TR	-12	-5.5	1.5	—	—	15	22	—	—	19	28	24	38	29	58	60	—	
	QS8J12	TR	-12	-4.5	1.5	—	—	21	29	—	—	27	38	37	55	49	98	40	—	
	QS8J2	TR	-12	-4	1.5	—	—	26	36	—	—	36	50	46	69	66	132	20	—	
	New QH8JA1	TCR	-20	-5	1.5	—	—	28	38	—	—	35	48	49	77	—	—	—	10.2	
	QS8J5	TR	-30	-5	1.5	28	39	40	56	45	63	—	—	—	—	—	—	—	10*1	
	QS8J4	TR	-30	-4	1.5	40	56	55	77	60	84	—	—	—	—	—	—	—	8.4*1	
	QH8MA4	TR	30	9*2	2.6*2	12.3	16	18.2	23.7	—	—	—	—	—	—	—	—	—	7.9	
			-30	-8*2	2.6*2	22	28.6	31	40.3	—	—	—	—	—	—	—	—	—	9.8	
	QH8MA3	TR	30	7*2	2.5*2	22	29	35	46	—	—	—	—	—	—	—	—	—	3.7	
			-30	-5.5*2	2.5*2	37	48	55	72	—	—	—	—	—	—	—	—	—	5.2	
QS8M13	TCR	30	6	1.5	20	28	25	35	28	39	—	—	—	—	—	—	—	5.5*1		
		-30	-5	1.5	28	39	40	56	45	63	—	—	—	—	—	—	—	10*1		
QH8MA2	TR	30	4.5	1.5	25	35	40	56	—	—	—	—	—	—	—	—	—	4.7		
		-30	-3	1.5	55	80	80	115	—	—	—	—	—	—	—	—	—	—	4.3	
QH8M22	TCR	40	4.5*3	1.5*3	34.6	46	43.9	59	—	—	—	—	—	—	—	—	—	1.3		
		-40	-2*3	1.5*3	130	190	180	260	—	—	—	—	—	—	—	—	—	—	4.4	
QS8M31	TR	60	3	1.5	80	112	93	130	98	137	—	—	—	—	—	—	—	—	4.0*1	
		-60	-2	1.5	150	210	180	252	190	266	—	—	—	—	—	—	—	—	7.2*1	
QS8M51	TR	100	2	1.5	240	325	250	340	260	355	—	—	—	—	—	—	—	—	4.7*1	
		-100	-1.5	1.5	350	470	380	510	400	540	—	—	—	—	—	—	—	—	17*1	

Notes1 : () : ROHM Packages
Notes2 : *1: V_{GS}=5V *2: PW≤1s *3: PW≤5s

☆: Under Development

● Quick Reference for Multiple Schottky Barrier Diodes Small Signal MOSFETs series (WEMT • TUMT • TSST • TSMT Package)

Dual type<MOSFET+SBD>

V _{DSS} [V]	I _D [A]			
	0.5	1	1.5	2
20			1.5A SOT-563T(WEMT6)[SC-120] / P.C9	2.5A SOT-25T(TSMT5) / P.C9
30			1.4A 1.5A SOT-563T(WEMT6)[SC-120] / P.C9	1.4A 1.5A SOT-353T(TUMT5)[SC-113CA] / P.C9
-12			1.3A SOT-563T(WEMT6)[SC-120] / P.C9	2A SOT-25T(TSMT5) / P.C9
-20			-1A SOT-563T(WEMT6)[SC-120] / P.C9	-1A SOT-353T(TUMT5)[SC-113CA] / P.C9
				(TSST8) / P.C9 -2.4A
				-1.5A SOT-25T(TSMT5) / P.C9
				-1.5A SOT-457T(TSMT6)[SC-95] / P.C9
-30				-2A SOT-25T(TSMT5) / P.C9
-45				-1A SOT-457T(TSMT6)[SC-95] / P.C9
				-0.7A SOT-353T(TUMT5)[SC-113CA] / P.C9

Notes1 : Package is JEDEC code. ():ROHM Packages, []:JEITA code
Notes2 : P.Cxx represents page number.

Package	Product No.		Polarity (ch)	V _{DSS} (V)	I _D (A)	P _D (W) (Ta=25°C)	R _{DS(on)} (mΩ)										Qg(nC) (V _{GS} =4.5V)
	Part No.	Taping Code					V _{GS} =10V					V _{GS} =4.5V					
							Typ.	Max.	Typ.	Max.	Typ.	Max.	Typ.	Max.	Typ.	Max.	
SOT-563T (WEMT6) [SC-120] 1616 size	ES6U2	T2R	N+SBD(0.5A)	20	1.5	0.8	—	—	130	180	—	—	170	240	300	600	1.8
	ES6U41	T2R		30	1.5	0.8	—	—	170	240	180	250	240	340	—	—	1.6
	ES6U3	T2R	P+SBD(0.5A)	30	1.4	0.8	170	240	250	350	270	380	—	—	—	—	1.4*1
	ES6U1	T2R		-12	-1.3	0.8	—	—	190	260	—	—	280	390	530	1060	2.4
	ES6U42	T2R		-20	-1	0.8	—	—	280	390	310	430	570	800	—	—	2.1
SOT-353T (TUMT5) [SC-113CA] 2021 size	US5U1	TR	N+SBD(0.5A)	30	1.5	1	—	—	170	240	180	250	240	340	—	—	1.6
	US5U2	TR		30	1.4	1	170	240	250	350	270	380	—	—	—	1.4*1	
	US5U30	TR	P+SBD(0.1A)	-20	-1	1	—	—	280	390	310	430	570	800	—	—	2.1
	US5U35	TR		-45	-0.7	1	600	800	900	1300	1000	1400	—	—	—	1.7*1	
(TSST8) 3019 size	TT8U1	TR	P+SBD(1A)	-20	-2.4	1.25	—	—	80	105	—	—	105	140	180	360	6.7
	TT8U2	TR		-20	-2.4	1.25	—	—	80	105	—	—	105	140	180	360	6.7
SOT-25T (TSMT5) 2928 size	QS5U36	TR	N+SBD(0.7A)	20	2.5	1.25	—	—	58	81	—	—	74	104	120	240	3.5
	QS5U34	TR	N+SBD(0.5A)	20	1.5	1.25	—	—	130	180	—	—	170	240	220*6	310*6	1.8
	QS5U13*2	TR	N+SBD(0.5A)	30	2	1.25	—	—	71	100	76	107	110	154	—	—	2.8
	QS5U16*2	TR		30	2	1.25	—	—	71	100	76	107	110	154	—	—	2.8
	QS5U12*3	TR	N+SBD(1A)	30	2	1.25	—	—	71	100	76	107	110	154	—	—	2.8
	QS5U17*3	TR		30	2	1.25	—	—	71	100	76	107	110	154	—	—	2.8
	QS5U28	TR	P+SBD(1A)	-20	-2	1.25	—	—	90	125	97	135	175	245	—	—	4.8
	QS5U23*4	TR		-20	-1.5	1.25	—	—	160	200	180	240	260	340	—	—	4.2
	QS5U26*4	TR	P+SBD(0.5A)	-20	-1.5	1.25	—	—	160	200	180	240	260	340	—	—	4.2
	QS5U21*5	TR		-20	-1.5	1.25	—	—	160	200	180	240	260	340	—	—	4.2
QS5U27*5	TR	P+SBD(1A)	-20	-1.5	1.25	—	—	160	200	180	240	260	340	—	—	4.2	
QS5U33	TR		-30	-2	1.25	95	135	145	205	160	225	—	—	—	—	3.4*1	
SOT-457T (TSMT6) [SC-95] 2928 size	QS6U22	TR	P+SBD(0.7A)	-20	-1.5	1.25	—	—	155	215	170	235	310	430	—	—	3
	QS6U24	TR		-30	-1	1.25	300	400	500	700	600	800	—	—	—	—	1.7*1

Notes1 : Package is JEDEC code. ():ROHM Packages, []:JEITA code
Notes2 : *1: V_{GS}=5V
Notes3 : *2, *3, *4, *5: Please note that, although the internal circuit configuration may differ between part numbers, the electrical specifications remain the same.
Notes4 : *6: V_{GS}=1.8V

Power MOSFETs

Quick Reference for Power MOSFETs series



Single type<Nch>

V_{DSS} [V]	1	2	3	4	5	6	7	8	9	10	20	30	40	50	
30			3A SOT-89(MPT3)[SC-62] / P.C11				6A DFN2020-8S(HUML2020L8 Single) / P.C11			11A		15A (HSMT8) / P.C11	39A		
40											(HSMT8) / P.C11	27A	39A		
60		2A SOT-89(MPT3)[SC-62] / P.C11					5.5A DFN2020-8S(HUML2020L8 Single) / P.C11							13A (HSMT8) / P.C11	30A

Dual type<Nch+Nch>

V_{DSS} [V]	1	2	3	4	5	6	7	8	9	10	20	30	40	50
30/30						5.5A DFN2020-8D(HUML2020L8 Dual) / P.C11				7A (HSML3030L10) / P.C11				
60/60			3A DFN2020-8D(HUML2020L8 Dual) / P.C11											

Single type<Pch>

V_{DSS} [V]	-1	-2	-3	-4	-5	-6	-7	-8	-9	-10	-20	-30	-40	-50
-20										10A DFN2020-8S(HUML2020L8 Single) / P.C11			30A (HSMT8) / P.C11	
-30							7.5A DFN2020-8S(HUML2020L8 Single) / P.C11							18A (HSMT8) / P.C11 -39A

Dual type<Pch+Pch>

V_{DSS} [V]	-1	-2	-3	-4	-5	-6	-7	-8	-9	-10
-20/-20					5A DFN2020-8D(HUML2020L8 Dual) / P.C11					
-30/-30				4A DFN2020-8D(HUML2020L8 Dual) / P.C11						

Dual type<Nch+Pch>

V_{DSS} [V]	1	2	3	4	5	6	7	8	9	10	20	30	40	50
20/-20					5A 5.5A DFN2020-8D(HUML2020L8 Dual) / P.C11									
30/-30				4A DFN2020-8D(HUML2020L8 Dual) / P.C11										

Notes1 : Package is JEDEC code. () :ROHM Packages, [] :JEITA code
Notes2 : P.Cxx represents page number.

Power MOSFETs series<MPT3·HUML2020L8·HSMT8·HSML3030L10 Package>																							
Package	Application	Product No.		Polarity (ch)	V _{DSS} (V)	I _D (A)	P _D (W) (Ta=25°C)	R _{DS(on)} (mΩ)												Qg(nC) (V _{GS} =4.5V)			
		Part No.	Taping Code					V _{GS} =10V		V _{GS} =4.5V		V _{GS} =4.0V		V _{GS} =2.5V		V _{GS} =1.8V		V _{GS} =1.5V					
								Typ.	Max.	Typ.	Max.	Typ.	Max.	Typ.	Max.	Typ.	Max.	Typ.	Max.				
	DC-DC Converter Motor Drive	RHP030N03	T100	N	30	3	2	90	120	—	—	160	210	—	—	—	—	—	—	6.5*2			
		RHP020N06	T100		60	2	2	150	200	200	280	240	340	—	—	—	—	—	—	7*2			
		RJP020N06	T100		60	2	2	—	—	165	240	170	250	210	300	—	—	—	—	—	5*3		
	DC-DC Converter	RF4E110GN	TR	N	30	11	2	8.7	11.3	11.7	16.5	—	—	—	—	—	—	—	—	3.5			
		RF4E080GN	TR		30	8	2	13.5	17.6	17.6	31.2	—	—	—	—	—	—	—	—	—	2.8		
		RF4E070GN	TR		30	7	2	16.4	21.4	23.0	33.0	—	—	—	—	—	—	—	—	—	2.2		
	Load Switch Switching	New RF4L055GN	TCR		60	5.5	2	31	43	45	66	—	—	—	—	—	—	—	—	—	4.1		
		RF4E110BN	TCR		30	11	2	8.5	11.1	11.8	15.4	—	—	—	—	—	—	—	—	—	12		
		RF4E100AJ	TCR		30	10	2	—	—	9.4	12.4	—	—	13.3	17.9	—	—	—	—	—	13		
		RF4E080BN	TR		30	8	2	13.5	17.6	18.9	24.6	—	—	—	—	—	—	—	—	—	7.2		
		RF4E070BN	TR		30	7	2	22.0	28.6	30.8	40.0	—	—	—	—	—	—	—	—	—	4.6		
		RF4E060AJ	TCR		30	6	2	—	—	28	37	—	—	41	55	—	—	—	—	—	4.0		
		RF4C050AP	TR		-20	-10	2	—	—	18	26	—	—	22	31	27	45	32	65	—	55		
		RF4C100BC	TCR		-20	-10	2	—	—	12.0	15.6	—	—	15.4	20.0	23.5	37.6	—	—	—	23.5		
RF4E075AT	TCR	-30	-7.5	2	16.7	21.7	24.4	31.7	—	—	—	—	—	—	—	—	—	11					
	Load Switch Switching	UT6K3	TCR	N+N	30	5.5	2	—	—	30	42	—	—	45	63	—	—	—	4.0				
		New UT6K30	TCR		60	3	2	111	153	162	223	—	—	—	—	—	—	—	—	1.1*2			
		UT6JA3	TCR	P+P	-20	-5	2	—	—	42	59	—	—	54	76	76	118	—	—	—	6.5		
	UT6JA2	TCR	-30		-4	2	55	70	80	103	—	—	—	—	—	—	—	—	—	3.4			
	Motor	UT6MA3	TBR	N+P	-20	5.5	2	—	—	30	42	—	—	45	63	—	—	—	—	4.0			
		New UT6MA2	TCR		-20	-5	2	—	—	42	59	—	—	54	76	—	—	—	—	—	6.5		
—		—	-30		-4	2	37	46	59	80	—	—	—	—	—	—	—	—	—	2.2			
	DC-DC Converter Switching	RQ3E180GN	TB	N	30	39*1	20*1	3.3	4.3	4.3	6.1	—	—	—	—	—	—	—	—	11.0			
		RQ3E150GN	TB		30	39*1	17*1	4.7	6.1	6.2	8.8	—	—	—	—	—	—	—	—	—	7.4		
		RQ3E120GN	TB		30	27*1	15*1	6.7	8.8	9.1	13.8	—	—	—	—	—	—	—	—	—	4.8		
		RQ3E100GN	TB		30	21*1	15*1	8.9	11.7	12.0	20.0	—	—	—	—	—	—	—	—	—	3.9		
		RQ3E080GN	TB		30	18*1	14*1	12.9	16.7	17.5	31.2	—	—	—	—	—	—	—	—	—	—	2.8	
		RQ3G150GN	TB		40	39*1	20*1	5.1	7.2	6.4	8.9	—	—	—	—	—	—	—	—	—	—	11.6	
		RQ3G100GN	TB		40	27*1	15*1	11.0	14.3	14.1	18.3	—	—	—	—	—	—	—	—	—	—	4.3	
		New RQ3L090GN	TB		60	30*1	20*1	10.3	13.9	14.6	21.4	—	—	—	—	—	—	—	—	—	—	13	
		RQ3L050GN	TB		60	13*1	15*1	43	61	61	86	—	—	—	—	—	—	—	—	—	—	2.8	
		Load Switch Switching	RQ3E180AJ		TB	N	30	30*1	30*1	—	—	3.5	4.5	—	—	4.5	5.8	—	—	—	—	—	39
			RQ3E180BN		TB		30	39*1	20*1	2.8	3.9	3.7	5.2	—	—	—	—	—	—	—	—	—	37
			RQ3E160AD		TB		30	16	2	3.5	4.5	5.0	7.0	—	—	—	—	—	—	—	—	—	25
	RQ3E150BN		TB	30	39*1		17*1	3.8	5.3	5.3	7.4	—	—	—	—	—	—	—	—	—	23		
	RQ3E130BN		TB	30	39*1		16*1	4.4	6.0	6.7	9.4	—	—	—	—	—	—	—	—	—	16		
	RQ3E120BN		TB	30	21*1		16*1	6.6	9.3	8.6	11.9	—	—	—	—	—	—	—	—	—	14		
	RQ3E110AJ		TB	30	24*1		15*1	—	—	8.8	11.7	—	—	12.6	16.5	—	—	—	—	—	13.5		
	RQ3E100BN		TB	30	21*1		15*1	7.7	10.4	11.0	15.3	—	—	—	—	—	—	—	—	—	10.5		
	RQ3E080BN		TB	30	15*1		14*1	11.0	15.2	16.0	22.0	—	—	—	—	—	—	—	—	—	7.2		
	RQ3E070BN		TB	30	15*1		13*1	20	27	29	39	—	—	—	—	—	—	—	—	—	4.6		
	RQ3C150BC		TB	P	-20		-30*1	20*1	—	—	4.8	6.7	—	—	6.1	8.5	8.8	14.0	—	—	—	60	
	RQ3E120AT		TB		-30		-39*1	20*1	6.1	8.0	8.7	11.3	—	—	—	—	—	—	—	—	—	33	
	☆RQ3E100AT	TB	-30		-31*1	17*1	9.0	11.4	13.1	16.7	—	—	—	—	—	—	—	—	—	21.0			
	RQ3E075AT	TB	-30		-18*1	15*1	17.4	23.0	26.0	33.0	—	—	—	—	—	—	—	—	—	10.4			
		DC-DC Converter	HS8S2	TB	N+N	30	10	2	11.2	14.6	14.7	20.0	—	—	—	—	—	—	—	—	2.7		
—			—	30		11	2	10.5	12.6	12.1	16.5	—	—	—	—	—	—	—	—	12			
HS8K1			TB	30		10	2	11.2	14.6	14.7	20.0	—	—	—	—	—	—	—	—	—	2.7		
—			—	30		11	2	9.1	11.8	11.9	16.5	—	—	—	—	—	—	—	—	—	3.3		
—			—	30		7	2	12.8	17.9	20.8	29.1	—	—	—	—	—	—	—	—	—	—	5.7	
—	—	—	—	30	11	2	10.2	13.3	11.8	15.4	—	—	—	—	—	—	—	—	—	9.0			

Notes1 : Package is JEDEC code. ():ROHM Packages, []:JEITA code
Notes2 : *1: Tc=25°C *2: V_{GS}=10V *3 V_{GS}=4V

☆: Under Development

Power MOSFETs

● Quick Reference for Power MOSFETs series(SOP8 Single/Dual Package)

SOP8 Single

SOP8 Dual

Single type<Nch>

V _{DSS} [V]	I _D [A]																							
	1	2	3	4	5	6	7	8	9	10	11	12	13	14	15	16	17	18						
30							7A	(SOP8 Single) / P.C13						13.5A										
45							7A	(SOP8 Single) / P.C13																
60				4.5A	(SOP8 Single) / P.C13													14A						

Dual type<Nch+Nch>

V _{DSS} [V]	I _D [A]																						
	1	2	3	4	5	6	7	8	9	10	11	12	13	14	15	16	17	18					
30/30				3.5A	(SOP8 Dual) / P.C13													15A					
40/40					5.2A	7A	(SOP8 Dual) / P.C13																
60/60					4.5A	(SOP8 Dual) / P.C13												8A					
80/80				3.4A	(SOP8 Dual) / P.C13																		
100/100			3A	(SOP8 Dual) / P.C13																			

Single type<Pch>

V _{DSS} [V]	I _D [A]																							
	-1	-2	-3	-4	-5	-6	-7	-8	-9	-10	-11	-12	-13	-14	-15	-16	-17	-18						
-30				4.4A	(SOP8 Single) / P.C13													18A						
-45							7A	(SOP8 Single) / P.C13																

Dual type<Pch+Pch>

V _{DSS} [V]	I _D [A]																							
	-1	-2	-3	-4	-5	-6	-7	-8	-9	-10	-11	-12	-13	-14	-15	-16	-17	-18						
-30/-30					-4.5A	(SOP8 Dual) / P.C13												-9A						
-60/-60					-4.5A	(SOP8 Dual) / P.C13																		

Dual type<Nch+Pch>

V _{DSS} [V]	I _D [A]																							
	1	2	3	4	5	6	7	8	9	10	11	12	13	14	15	16	17	18						
30/-30				3.5A	(SOP8 Dual) / P.C13													9A						
45/-45				3.5A	4.5A	(SOP8 Dual) / P.C13																		
60/-60					4.5A	(SOP8 Dual) / P.C13																		
80/-80				2.6A	3.4A	(SOP8 Dual) / P.C13																		
100/-100			2.5A3A	(SOP8 Dual) / P.C13																				

Notes1 : () :ROHM Packages
Notes2 : P.Cxx represents page number.

C

Transistors

Power MOSFETs series

<SOP8 Package> (Single type)																	
Package	Product No.		Polarity (ch)	V _{DSS} (V)	I _D (A)	P _D (W) (Ta=25°C)	R _{DS(on)} (mΩ)										Qg(nC) (VGS=5V)
	Part No.	Taping Code					V _{GS} =10V		V _{GS} =4.5V		V _{GS} =4.0V		V _{GS} =2.5V		V _{GS} =1.5V		
							Typ.	Max.	Typ.	Max.	Typ.	Max.	Typ.	Max.	Typ.	Max.	
(SOP8) 5060 size	RS3E135BN	TB	N	30	13.5	2.0	5.7	7.4	8.5	10.9	—	—	—	—	—	16.6*1	
	RXH125N03	TB		30	12.5	2.0	7.5	12	9.5	13.3	10	14	—	—	—	12.7	
	RXH100N03	TB		30	10	2.0	9.5	13	12	17	13	18	—	—	—	11	
	RS3E095BN	TB		30	9.5	2.0	11.9	14.6	17.5	21.9	—	—	—	—	—	8.3*1	
	RXH090N03	TB		30	9	2.0	12	17	17	24	19	27	—	—	—	6.8	
	RXH070N03	TB		30	7	2.0	20	28	25	35	28	39	—	—	—	5.8	
	RSH070N05	TB		45	7	2.0	18	25	23	32	25	35	—	—	—	12	
	New RS3L140GN	TB		60	14	2.0	4.9	6.5	6.8	9.6	—	—	—	—	—	31*1	
	RSH065N06	TB		60	6.5	2.0	24	37	28	44	31	48	—	—	—	11	
	New RS3L045GN	TB		60	4.5	2.0	43	59	62	92	—	—	—	—	—	3*1	
	☆RS3E180AT	TB1		P	-30	-18	2.0	4.1	4.8	5.1	6.1	—	—	—	—	—	80
	RRH140P03	TB			-30	-14	2.0	5	7	6.7	9.4	7.3	10.2	—	—	—	80
	☆RS3E130AT	TB1	-30		-13	2.0	6.5	8.5	8.6	11.2	—	—	—	—	—	41.1	
	RRH100P03	TB	-30		-10.0	2.0	9	12.6	12.5	17.5	14	19.6	—	—	—	39	
	RRH090P03	TB1	-30		-9	2.0	11	15.4	15	21	17	24	—	—	—	30	
	RS3E075AT	TB	-30		-7.5	2.0	18	23.5	24	31	—	—	—	—	—	12.8*1	
	New RSH050P03	TB	-30		-5	2.0	30	42	47	65	55	77	—	—	—	13	
	RRH050P03	TB1	-30		-5	2.0	36	50	52	72	58	80	—	—	—	9.2	
	New RSH040P03	TB	-30		-4	2.0	42	58	68	92	78	106	—	—	—	8	
	RRH040P03	TB	-30		-4	2.0	55	75	85	115	95	125	—	—	—	5.2	
	RSH070P05	TB1	-45	-7	2.0	19	27	25	35	28	39	—	—	—	34		

<SOP8 Package> (Dual type)													
Package	Product No.		Polarity (ch)	V _{DSS} (V)	I _D (A)	P _D (W) (Ta=25°C)	R _{DS(on)} (mΩ)						Qg(nC) (VGS=5V)
	Part No.	Taping Code					V _{GS} =10V		V _{GS} =4.5V		V _{GS} =4.0V		
							Typ.	Max.	Typ.	Max.	Typ.	Max.	
(SOP8) 5060 size	New SH8K10S	TB	N	30	7	2.0	17	24	23	33	25	35	8.4
	New SH8KA7	TB		N+SBD	30		8.5	14	19.6	17.8	24.9	19	26.6
	New SH8KA4	TB	N+N	30	15*3	4.6*3	7.1	9.1	8.3	10.7	—	—	41*1
	New SH8KA2	TB		30	9*3	3*3	16.5	21.4	22.2	28.9	—	—	7.9*1
	New SH8K12	TB		30	8*3	2.8*3	23	28	34	43	—	—	4.1*1
	SH8K11	TB		30	6*3	2	30	42	40	56	45	63	4
	New SH8KA1	TB		30	4.5*3	2.7*3	54	69	84	109	—	—	1.6*1
	SH8K11	TB		30	3.5	2	70	98	90	126	100	140	1.9
	SH8K26	TB		40	7	2	27	38	35	50	—	—	2.9
	SH8K25	TB		40	5.2*3	3*3	60	85	80	112	—	—	1.7
	New SH8K39	TB		60	8*3	2*3	15	21	20	30	—	—	12.8*1
	New SH8K37	TB		60	5.5*3	2*3	33	46	44	66	—	—	5.2*1
	SH8K32	TB		60	4.5	2	46	65	52	73	55	77	7
	SH8K41	TB		80	3.4	2	90	130	110	150	120	160	6.6
	SH8K52	TB		100	3	2	120	170	135	190	—	—	8.5
	SH8J66	TB		-30	-9	2	13.5	18.5	17.5	23.6	19	24.7	35
	SH8J65	TB		-30	-7	2	21.5	29	29	39	31	040.8	18
	SH8J62	TB		-30	-4.5	2	40	56	55	77	60	84	8
	SH8J31	TB		-60	-4.5	2	50	70	55	80	60	85	40*2
	New SH8MA4	TB1		N+P	30	9*3	2*3	16.5	21.4	22.2	32.5	—	—
	New SH8MA3	TB1	-30		-8.5*3	23		29.6	32	41.3	—	—	9.8*1
	New SH8MA2	TB	30		7*3	2*3	23	28	42	57	—	—	3.7*1
	SH8M14	TB	-30		-6*3		40	50	60	73	—	—	5.2*1
	SH8M13	TB	30		4.5*3	2*3	57	80	88	125	—	—	3
	SH8M12	TB	-30		-4.5*3		63	82	89	115	—	—	6.7
	SH8M11	TB	30		9	2	15	21	18	25	20	28	8.5
	SH8M10	TB	-30		-7		21.5	29	29	39	31	40.8	18
	SH8M09	TB	30		6	2	22	31	30	42	35	49	5
	SH8M08	TB	-30		-7		21.5	29	29	39	31	40.8	18
	SH8M07	TB	30		5	2	30	42	40	56	45	63	4
	SH8M06	TB	-30		-4.5		40	56	55	77	60	84	8
	SH8M05	TB	30	3.5	2	70	98	90	126	100	140	1.9	
	SH8M04	TB	-30	-3.5		70	98	100	140	110	155	4.2	
	SH8M03	TB	45	4.5	2	33	46	41	57	46	64	6.8	
	SH8M02	TB	-45	-3.5		45	63	60	84	66	92	13	
	New SH8M31	TB	60	4.5	2	46	65	52	73	55	77	7*1	
	SH8M30	TB	-60	-4.5		50	70	55	80	60	85	20*1	
	SH8M41	TB	80	3.4	2	90	130	110	150	120	160	6.6	
	SH8M51	TB	-80	-2.6		165	240	220	300	230	310	8.2	
	SH8M61	TB	100	3	2	120	170	130	180	135	190	8.5	
SH8M71	TB	-100	-2.5	210		290	230	320	240	340	12.5		

Notes1 : () :ROHM Packages
Notes2 : *1: V_{GS}=4.5V *2: V_{GS}=10V *3: PW≤1s

☆: Under Development

Power MOSFETs

Quick Reference for Power MOSFETs series(HSOP8 Single type)

Single type<Nch>

(HSOP8) Single

V _{DSS} [V]	Feature	10	20	30	40	50	60	70	80
30	Switching				35A		(HSOP8)Single / P.C14		80A
40					34A		(HSOP8)Single / P.C14		80A
60					36A		68A	(HSOP8)Single / P.C14	
100							60A	(HSOP8)Single / P.C14	

Single type<Pch>

V _{DSS} [V]	Feature	-10	-20	-30	-40	-50	-60	-70	-80
-30	Switching							(HSOP8)Single / P.C14 -76A-80A	

Notes1 : () :ROHM Packages Notes2 : P.Cxx represents page number.

(HSOP8 Single type)													
Package	Application	Product No.		Polarity (ch)	V _{DSS} (V)	I _D (A) (T _c =25°C)	P ₀ (W) (T _c =25°C)	R _{DS(on)} (mΩ)				Q _g (nC) (V _{GS} =4.5V)	Drive Voltage (V)
		Part No.	Taping Code					V _{GS} =10V		V _{GS} =4.5V			
								Typ.	Max.	Typ.	Max.		
	Load Switch	RS1E350BN	TB	N	30	80	35	1.2	1.7	1.8	2.5	95	4.5
		RS1E280BN	TB		30	80	30	1.7	2.3	2.3	3.2	50	
		RS1E240BN	TB		30	40	30	2.3	3.2	3.3	4.6	35	
		RS1E200BN	TB		30	68	25	2.8	3.9	3.8	5.3	29	
		RS1E180BN	TB		30	60	25	3.5	4.9	4.9	6.9	23	
		☆RS1E260AT	TB		P	-30	-80	40	2.4	3.0	3.4	4.3	
	☆RS1E220AT	TB	-30	-76		34	3.3	4.1	4.6	5.8	65		
	DC-DC Converter Switching	RS1E350GN	TB	N	30	80	39	1.48	1.76	1.92	2.4	32.7	
		RS1E320GN	TB		30	80	34	1.4	1.9	1.8	2.9	19.6	
		RS1E300GN	TB		30	80	33	1.7	2.2	2.2	3.3	18.5	
		RS1E280GN	TB		30	80	31	2.0	2.6	2.6	3.8	17.1	
		RS1E240GN	TB		30	72	27	2.6	3.3	3.3	5.2	11.2	
		RS1E200GN	TB		30	57	25	3.6	4.6	4.7	7.5	7.8	
		RS1E170GN	TB		30	40	23	5.1	6.7	6.7	10.3	5.9	
		RS1E150GN	TB		30	40	22	6.7	8.8	8.8	13.3	4.8	
		RS1E130GN	TB		30	35	22	8.9	11.7	11.7	17.7	3.9	
		RS1G300GN	TB		40	80	35	1.9	2.5	2.4	3.0	28.6	
		RS1G260MN	TB		40	80	35	2.4	3.3	3.2	4.4	44*	
		RS1G180MN	TB		40	57	30	5.0	7.0	6.7	9.2	19.5*	
		RS1G150MN	TB		40	43	25	7.6	10.6	10.2	13.3	15*	
		RS1G120MN	TB		40	34	25	11.6	16.2	15.6	20.7	9.4*	
New RS1L180GN		TB	60		68	39	4.2	5.6	5.9	8.5	34		
New RS1L145GN	TB	60	46	31	6.7	9.7	9.6	14.1	19.5				
New RS1L120GN	TB	60	36	27	9.3	12.7	13.4	19.8	14				
☆RS1P600BE	TB	100	60	35	7.4	8.8	—	—	33*	10			

Notes1 : () :ROHM Packages Notes2 : *V_{GS}=10V

☆: Under Development

Quick Reference for Power MOSFETs series(HSOP8 Dual type)

Dual type<Nch+Nch>

HSOP8 Dual

V _{DSS} [V]	Feature	10	20	30	40	50	60	70	80
30/30	Switching	HSOP8 Dual(N+N) / P.C14							80A
		HSOP8 Dual(N+N+SBD) / P.C14							80A

Dual type<Nch+Pch>

V _{DSS} [V]	Feature	1	5	10	15	20	25	
30/-30	Motor	HSOP8 Dual / P.C14					15A	18A
60/-60		HSOP8 Dual / P.C14					8.5A	
100/-100		HSOP8 Dual / P.C14					4.5A	

Notes1 : () :ROHM Packages Notes2 : P.Cxx represents page number.

(HSOP8 Dual type)													
Package	Application	Product No.		Polarity (ch)	V _{DSS} (V)	I _D (A) (T _a =25°C)	P ₀ (W) (T _a =25°C)	R _{DS(on)} (mΩ)				Q _g (nC) (V _{GS} =4.5V)	Drive Voltage (V)
		Part No.	Taping Code					V _{GS} =10V		V _{GS} =4.5V			
								Typ.	Max.	Typ.	Max.		
	Switching	HP8K24	TB	N+N	30	80*1	31*1	2.3	3	3.2	4.2	17.2	
					30	27*1	22*1	6.7	8.8	9.1	13.3	4.8	
					30	57*1	25*1	3.6	4.6	4.7	7.5	7.8	
		HP8K22	TB	30	27*1	22*1	6.7	8.8	9.1	13.3	4.8		
				30	80*1	29*1	2	2.4	2.3	2.8	4.7		
HP8S36	TB	N+SBD	30	27*1	22*1	6.7	8.8	9.1	13.3	4.8			
	Motor	HP8MA2	TB1	N+P	30	18*2	7*2	7.5	9.6	11.7	16.5	10.5	
					-30	-15*2	7*2	13.2	17.9	21	29	12.8	
					60	8.5*2	7*2	46	65	52	73	6.2	
					-60	-8.5*2	7*2	50	70	55	80	15.7	
					100	4.5*2	7*2	120	170	130	180	8.5*3	
New HP8M31	TB1												
New HP8M51	TB1												
	Load Switch	HP8KA1	TB	N+N	30	14*1	3*1	3.5	5	5	7	24	

Notes1 : () :ROHM Packages Notes2 : *1: T_c=25°C *2: P_w<1s *3: V_{GS}=5V

Quick Reference for Power MOSFETs series

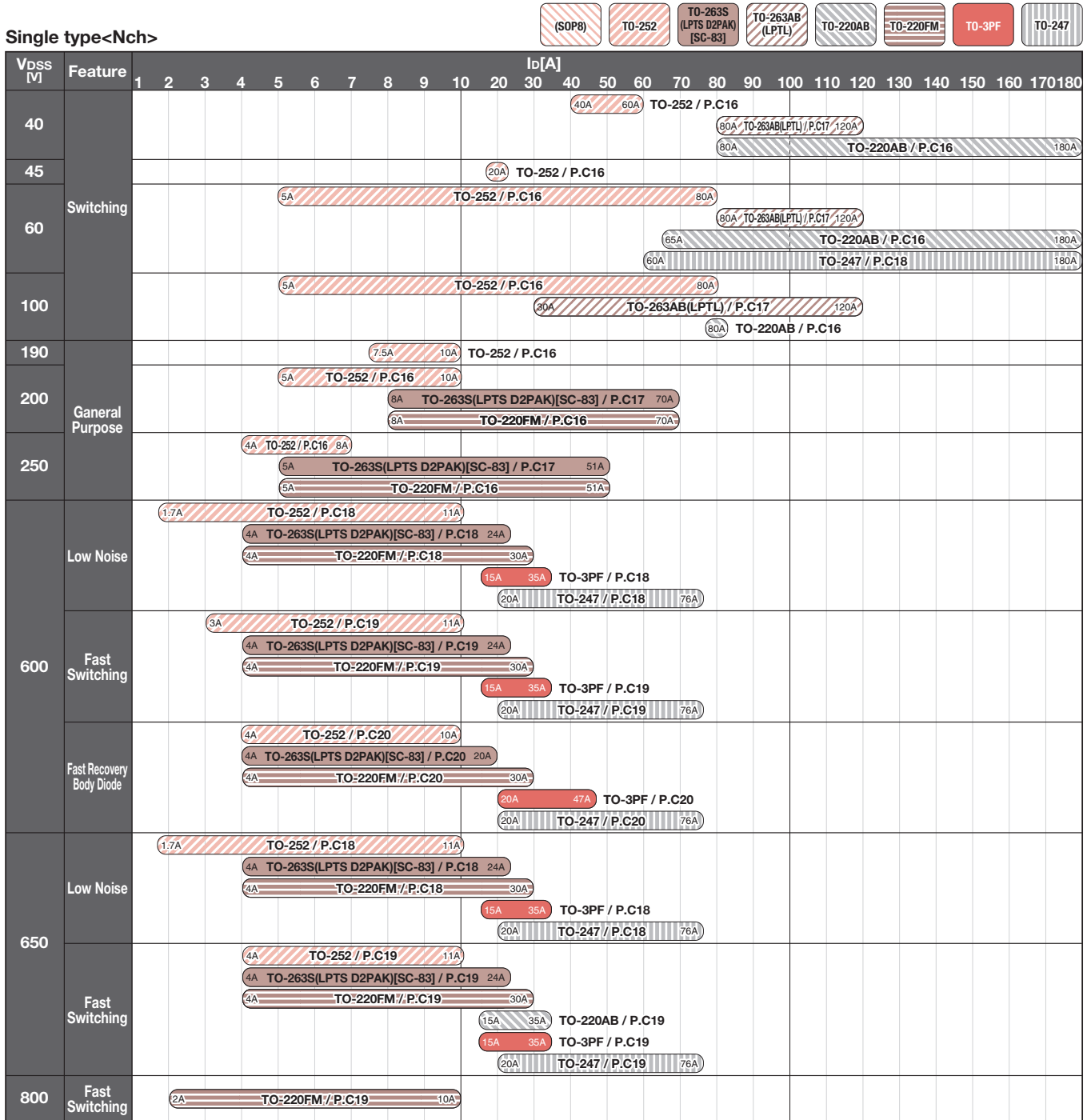

Dual type<Nch+Nch>

V _{DSS} [V]	Feature	I _D [A]
500/500	General Purpose	0.5A (SOP8) / P.C19

Single type<Pch>

V _{DSS} [V]	Feature	-1	-2	-3	-4	-5	-6	-7	-8	-9	-10	-20	-30
-45	Switching												
-60													
-100													

Notes1 : Package is JEDEC code. ():ROHM Packages, []:JEITA code
Notes2 : P.Cxx represents page number.



Power MOSFETs

Power MOSFETs

Power MOSFETs series																
Package	Product No.		Polarity (ch)	V _{DS} (V)	I _D (A) (T _C =25°C)	P _C (W) (T _C =25°C)	R _{DS(on)} (mΩ)								Q _g (nC) (V _{GS} =10V)	
	Part No.	Taping Code					V _{GS} =10V		V _{GS} =6.0V		V _{GS} =4.5V		V _{GS} =4.0V			
							Typ.	Max.	Typ.	Max.	Typ.	Max.	Typ.	Max.		
TO-252	RD3G600GN	TL	N	40	60	40	2.8	3.6	—	—	3.3	4.3	—	—	46.5	
	RD3G500GN	TL		40	50	35	3.9	4.9	—	—	4.7	6.3	—	—	31	
	RD3G400GN	TL		40	40	26	5.6	7.5	—	—	7	9.5	—	—	19	
	<i>New</i> RD3H200SN	TL1		45	20	20	20	28	—	—	25	35	28	40	12*2	
	<i>New</i> RD3L08BGN	TL		60	80*1	119	4.2	5.1	—	—	5.7	8	—	—	71	
	<i>New</i> RD3L08CGN	TL1		60	80*1	96	5.3	7	—	—	7.4	10.7	—	—	55	
	<i>New</i> RD3L06BGN	TL1		60	60*1	65.7	9.9	13.5	—	—	14.3	21	—	—	25	
	<i>New</i> RD3L220SN	TL1		60	22	20	18	26	—	—	21	30	23	33	30	
	<i>New</i> RD3L150SN	TL1		60	15	20	28	40	—	—	33	47	36	51	18	
	<i>New</i> RD3L080SN	TL1		60	8	15	57	80	—	—	70	98	78	109	9.4	
	<i>New</i> RD3L050SN	TL1		60	5.0	15	78	109	—	—	94	131	100	140	8	
	☆ RD3P08BBD	TL		100	80*1	114	8.1	11.7	11	16	—	—	—	—	37	
	<i>New</i> RD3P200SN	TL1		100	20	20	33	46	—	—	—	—	36	50	55	
	<i>New</i> RD3P175SN	TL1		100	17.5	20	75	105	—	—	80	112	85	119	24	
	<i>New</i> RD3P100SN	TL1		100	10	20	95	133	—	—	100	140	105	147	18	
	<i>New</i> RD3P050SN	TL1		100	5.0	15	135	190	—	—	142	200	145	205	14	
	<i>New</i> RD3S100CN	TL1		190	10	85	130	182	—	—	—	—	136	190	52	
	<i>New</i> RD3S075CN	TL1		190	7.5	52	240	336	—	—	—	—	248	347	30	
	<i>New</i> RD3T100CN	TL1		200	10	85	140	182	—	—	—	—	—	—	25	
	<i>New</i> RD3T075CN	TL1		200	7.5	52	250	325	—	—	—	—	—	—	15	
	<i>New</i> RD3T050CN	TL1		200	5	29	540	760	—	—	—	—	—	—	8.3	
	<i>New</i> RD3U080CN	TL1		250	8	85	225	300	—	—	—	—	—	—	25	
	<i>New</i> RD3U060CN	TL1		250	6	52	410	530	—	—	—	—	—	—	15	
	<i>New</i> RD3U040CN	TL1		250	4	29	930	1300	—	—	—	—	—	—	8.5	
	<i>New</i> RD3H160SP	TL1		—	-45	-16	20	35	50	—	—	45	63	50	70	16*2
	<i>New</i> RD3H080SP	TL1		—	-45	-8	15	65	91	—	—	95	133	105	147	9*2
<i>New</i> RD3H045SP	TL1	—	-45	-4.5	15	112	157	—	—	160	224	185	259	5.6*2		
<i>New</i> RD3L140SP	TL1	—	-60	-14	20	60	84	—	—	73	103	77	108	27		
<i>New</i> RD3P130SP	TL1	—	-100	-13	20	135	200	—	—	150	220	155	230	40		
TO-220FM	RCX700N20	—	N	200	70	83	30.5	42.7	—	—	—	—	—	125		
	RCX450N20	—		200	45	69	42	55	—	—	—	—	—	80		
	RCX300N20	—		200	30	61	60	80	—	—	—	—	—	60		
	RCX200N20	—		200	20	48	100	130	—	—	—	—	—	40		
	RCX160N20	—		200	16	43	135	180	—	—	—	—	—	26		
	RCX120N20	—		200	12	40	250	325	—	—	—	—	—	15		
	RCX081N20	—		200	8	40	470	770	—	—	—	—	—	9		
	RCX511N25	—		250	51	84	48	65	—	—	—	—	—	120		
	RCX330N25	—		250	33	69	77	105	—	—	—	—	—	80		
	RCX220N25	—		250	22	61	105	140	—	—	—	—	—	60		
	RCX120N25	—		250	12	48	180	235	—	—	—	—	—	35		
	RCX100N25	—		250	10	43	245	320	—	—	—	—	—	26.5		
	RCX080N25	—		250	8	35	460	600	—	—	—	—	—	15		
	RCX051N25	—		250	5	30	970	1360	—	—	—	—	—	9		
TO-220AB	RX1G18BGN	C10	N	40	180	208	1.17	1.64	—	—	1.33	1.87	—	—	168	
	<i>New</i> RX1G08CGN	C10		40	80	78	3.5	4.7	—	—	4.4	5.9	—	—	32	
	<i>New</i> RX1L18CGN	C10		60	180	208	1.59	2.15	—	—	2.17	3.26	—	—	190	
	<i>New</i> RX1L18BGN	C10		60	180	166	2	2.7	—	—	2.77	4.16	—	—	139	
	<i>New</i> RX1L16BGN	C10		60	160	125	2.9	4	—	—	4.1	6.2	—	—	88	
	<i>New</i> RX1L08BGN	C10		60	80	96	5.2	7.2	—	—	7.3	12.3	—	—	55	
	<i>New</i> RX1L06BGN	C10		60	65	65	10.2	13.8	—	—	14.5	23.8	—	—	25	
	☆ RX1P08BBE	—		100	80*1	114	6.8	8.2	—	—	—	—	—	—	55	

Notes1 : Package is JEDEC code.
Notes2 : *1: V_{GS}=10V *2: V_{GS}=4.5V

☆: Under Development

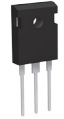
Power MOSFETs series															
Package	Product No.		Polarity (ch)	V _{DSS} (V)	I _D (A) (T _C =25°C)	P _D (W) (T _C =25°C)	R _{DS(on)} (mΩ)								Qg(nC) (V _{GS} =10V)
	Part No.	Taping Code					V _{GS} =10V		V _{GS} =6.0V		V _{GS} =4.5V		V _{GS} =4.0V		
							Typ.	Max.	Typ.	Max.	Typ.	Max.	Typ.	Max.	
TO-263AB (LPTL) 	RJ1G12BGN	TLL	N	40	120*1	178	1.38	1.86	—	—	1.54	2.08	—	—	165
	RJ1G08CGN	TLL		40	80*1	78	4.2	5.6	—	—	5	6.7	—	—	31.1
	<i>New</i> RJ1L12BGN	TLL		60	120*1	192	2.1	2.9	—	—	2.7	4.1	—	—	175
	<i>New</i> RJ1L12CGN	TLL		60	120*1	166	2.5	3.4	—	—	3.2	4.8	—	—	139
	<i>New</i> RJ1L12DGN	TLL		60	120*1	125	3.9	5.3	—	—	5.1	7.7	—	—	88
	<i>New</i> RJ1L08CGN	TLL		60	80*1	96	5.3	7	—	—	7.4	10.7	—	—	55
	<i>New</i> RJ1P12BBD	TLL		100	120*1	178	3.8	5.3	4.9	7	—	—	—	—	91.5
TO-263S (LPTS D2PAK) [SC-83] 	RSJ650N10	TL	N	100	65	100	6.5	9.1	—	—	—	—	7	9.8	260
	RSJ550N10	TL		100	55	100	12	16.8	—	—	—	—	13.5	18.9	143
	RSJ400N10	TL		100	40	50	19	27	—	—	—	—	21	30	90
	RSJ301N10	TL		100	30	50	33	46	—	—	—	—	36	50	60
	RCJ700N20	TL		200	70	297	30.5	42.7	—	—	—	—	—	—	125
	RCJ450N20	TL		200	45	211	42	55	—	—	—	—	—	—	80
	RCJ300N20	TL		200	30	166	60	80	—	—	—	—	—	—	60
	RCJ200N20	TL		200	20	106	100	130	—	—	—	—	—	—	40
	RCJ160N20	TL		200	16	85	135	180	—	—	—	—	—	—	26
	RCJ120N20	TL		200	12	52	250	325	—	—	—	—	—	—	15
	RCJ081N20	TL		200	8	40	550	770	—	—	—	—	—	—	9
	RCJ510N25	TL		250	51	304	48	65	—	—	—	—	—	—	120
	RCJ330N25	TL		250	33	211	77	105	—	—	—	—	—	—	80
	RCJ220N25	TL		250	22	166	105	140	—	—	—	—	—	—	60
	RCJ120N25	TL		250	12	107	180	235	—	—	—	—	—	—	35
	RCJ100N25	TL		250	10	85	245	320	—	—	—	—	—	—	26.5
	RCJ050N25	TL		250	5	30	970	1360	—	—	—	—	—	—	9
	RSJ250P10	TL	P	-100	-25	50	45	63	—	—	48	67	50	70	60*2
	RSJ151P10	TL		-100	-15	50	85	120	—	—	95	135	100	140	64
TO-247 	<i>New</i> RZ2L18BGN	C11	N	60	180*1	208	2.1	2.9	—	—	—	—	—	190	
	<i>New</i> RZ2L18CGN	C11		60	180*1	166	2.5	3.4	—	—	—	—	—	—	139







Notes1 : Package is JEDEC code. () :ROHM Packages, [] :JEITA code
Notes2 : *1: V_{GS}=10V *2: V_{GS}=5V

Power MOSFETs

Low Noise type														
Package	Application	Product No.		Polarity (ch)	V _{DSS} (V)	I _D (A)	P _D (W) (Tc=25°C)	R _{DS(on)} (Ω)		Qg Typ.(nC) V _{GS} =10V	Drive Voltage (V)			
		Part No.	Taping Code					V _{GS} =10V						
								Typ.	Max.					
TO-252		New R6011END3	TL1	N	600	11	124	0.340	0.390	32	10			
		New R6009END3	TL1		600	9	94	0.500	0.535	23	10			
		New R6007END3	TL1		600	7	78	0.570	0.620	20	10			
		New R6004END3	TL1		600	4	59	0.900	0.980	15	10			
		New R6002END3	TL1		600	1.7	26	2.800	3.400	6.5	10			
		☆ R6511END3	TL1		650	11	124	0.360	0.400	32	10			
		☆ R6509END3	TL1		650	9	94	0.530	0.585	24	10			
		☆ R6507END3	TL1		650	7	78	0.605	0.665	20	10			
		☆ R6504END3	TL1		650	4	59	0.955	1.050	15	10			
		☆ R6502END3	TL1		650	1.7	24	3.000	3.300	6.5	10			
TO-263S (LPTS D2PAK) [SC-83]		R6024ENJ	TL	N	600	24	245	0.150	0.165	70	10			
		R6020ENJ	TL		600	20	231	0.170	0.196	60	10			
		R6015ENJ	TL		600	15	184	0.260	0.290	40	10			
		R6011ENJ	TL		600	11	124	0.340	0.390	32	10			
		R6009ENJ	TL		600	9	94	0.500	0.535	23	10			
		R6007ENJ	TL		600	7	78	0.570	0.620	20	10			
		R6004ENJ	TL		600	4	58	0.900	0.980	15	10			
		New R6524ENJ	TL		650	24	245	0.160	0.185	70	10			
		New R6520ENJ	TL		650	20	231	0.185	0.205	61	10			
		New R6515ENJ	TL		650	15	184	0.280	0.315	40	10			
		New R6511ENJ	TL		650	11	124	0.360	0.400	32	10			
		New R6509ENJ	TL		650	9	94	0.530	0.585	24	10			
		New R6507ENJ	TL		650	7	78	0.605	0.665	20	10			
		New R6504ENJ	TL		650	4	58	0.955	1.050	15	10			
TO-220FM	Switching	R6030ENX	—*	N	600	30	86	0.115	0.130	85	10			
		R6024ENX	—*		600	24	74	0.150	0.165	70	10			
		R6020ENX	—*		600	20	68	0.170	0.196	60	10			
		R6015ENX	—*		600	15	60	0.260	0.290	40	10			
		R6011ENX	—*		600	11	53	0.340	0.390	32	10			
		R6009ENX	—*		600	9	48	0.500	0.535	23	10			
		R6007ENX	—*		600	7	46	0.570	0.620	20	10			
		R6004ENX	—*		600	4	35	0.900	0.980	15	10			
		New R6530ENX	—*		650	30	86	0.125	0.140	90	10			
		New R6524ENX	—*		650	24	74	0.160	0.185	70	10			
		New R6520ENX	—*		650	20	68	0.185	0.205	61	10			
		New R6515ENX	—*		650	15	60	0.280	0.315	40	10			
		New R6511ENX	—*		650	11	53	0.360	0.400	32	10			
		New R6509ENX	—*		650	9	48	0.530	0.585	24	10			
		New R6507ENX	—*		650	7	46	0.605	0.665	20	10			
		New R6504ENX	—*		650	4	35	0.955	1.050	15	10			
		TO-3PF			R6035ENZ	C8	N	600	35	102	0.095	0.102	110	10
					R6030ENZ	C8		600	30	86	0.115	0.130	85	10
R6024ENZ	C8			600	24	74		0.150	0.165	70	10			
R6020ENZ	C8			600	20	68		0.170	0.196	60	10			
R6015ENZ	C8			600	15	60		0.260	0.290	40	10			
New R6535ENZ	C8			650	35	102		0.098	0.115	113	10			
New R6530ENZ	C8			650	30	86		0.125	0.140	90	10			
New R6524ENZ	C8			650	24	74		0.160	0.185	70	10			
New R6520ENZ	C8			650	20	68		0.185	0.205	61	10			
New R6515ENZ	C8			650	15	60		0.280	0.315	40	10			
TO-247		R6076ENZ1	C9	N	600	76	735	0.038	0.042	260	10			
		R6047ENZ1	C9		600	47	481	0.066	0.072	145	10			
		R6035ENZ1	C9		600	35	379	0.095	0.102	110	10			
		R6030ENZ1	C9		600	30	305	0.115	0.130	85	10			
		R6024ENZ1	C9		600	24	245	0.150	0.165	70	10			
		R6020ENZ1	C9		600	20	231	0.170	0.196	60	10			
		New R6576ENZ1	C9		650	76	735	0.040	0.046	260	10			
		New R6547ENZ1	C9		650	47	481	0.070	0.080	145	10			
		New R6535ENZ1	C9		650	35	379	0.098	0.115	110	10			
		New R6530ENZ1	C9		650	30	305	0.125	0.140	85	10			
		New R6524ENZ1	C9		650	24	245	0.160	0.185	70	10			
		New R6520ENZ1	C9		650	20	231	0.185	0.205	60	10			

Notes1 : Package is JEDEC code. () :ROHM Packages, [] :JEITA code
Notes2 : *: Packaging type C7 allows the tube.

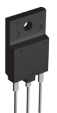
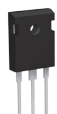
☆: Under Development

Fast Switching type														
Package	Application	Product No.		Polarity (ch)	V _{DSS} (V)	I _D (A)	P _D (W) (T _C =25°C)	R _{DS(on)} (Ω)		Q _g Typ.(nC) V _{GS} =10V	Drive Voltage (V)			
		Part No.	Taping Code					V _{GS} =10V						
								Typ.	Max.					
TO-252 		New R6011KND3	TL1	N	600	11	124	0.340	0.390	22	10			
		New R6009KND3	TL1		600	9	94	0.500	0.535	16.5	10			
		New R6007KND3	TL1		600	7	78	0.570	0.620	15	10			
		New R6006KND3	TL1		600	6	70	0.720	0.830	12	10			
		New R6003KND3	TL1		600	3	44	1.300	1.500	8	10			
		☆ R6511KND3	TL1		650	11	124	0.360	0.400	22	10			
		☆ R6509KND3	TL1		650	9	94	0.530	0.585	16.5	10			
		☆ R6507KND3	TL1		650	7	78	0.605	0.665	15	10			
		☆ R6504KND3	TL1		650	4	58	0.955	1.050	10	10			
		TO-263S (LPTS D2PAK) [SC-83] 			R6024KNJ	TL	N	600	24	245	0.150	0.165	46	10
R6020KNJ	TL			600	20	231		0.170	0.196	40	10			
R6015KNJ	TL			600	15	184		0.260	0.290	30	10			
R6011KNJ	TL			600	11	124		0.340	0.390	22	10			
R6009KNJ	TL			600	9	94		0.500	0.535	16.5	10			
R6007KNJ	TL			600	7	78		0.570	0.620	15	10			
R6004KNJ	TL			600	4	58		0.900	0.980	10	10			
New R6524KNJ	TL			650	24	245		0.160	0.185	46	10			
New R6520KNJ	TL			650	20	231		0.185	0.205	40	10			
New R6515KNJ	TL			650	15	184		0.280	0.315	30	10			
New R6511KNJ	TL			650	11	124		0.360	0.400	22	10			
New R6509KNJ	TL			650	9	94		0.530	0.585	16.5	10			
New R6507KNJ	TL			650	7	78		0.605	0.665	15	10			
New R6504KNJ	TL			650	4	58		0.955	1.050	10	10			
TO-220FM 	Switching			R6030KNX	—s	N		600	30	86	0.115	0.130	56	10
				R6024KNX	—s			600	24	74	0.150	0.165	46	10
		R6020KNX	—s	600	20		68	0.170	0.196	40	10			
		R6015KNX	—s	600	15		60	0.260	0.290	30	10			
		R6011KNX	—s	600	11		53	0.340	0.390	22	10			
		R6009KNX	—s	600	9		48	0.500	0.535	16.5	10			
		R6007KNX	—s	600	7		46	0.570	0.620	15	10			
		New R6006KNX	—s	600	6		40	0.720	0.830	12	10			
		R6004KNX	—s	600	4		35	0.900	0.980	10	10			
		New R6530KNX	—s	650	30		86	0.125	0.140	56	10			
		New R6524KNX	—s	650	24		74	0.160	0.185	46	10			
		New R6520KNX	—s	650	20		68	0.185	0.205	40	10			
		New R6515KNX	—s	650	15		60	0.280	0.315	30	10			
		New R6511KNX	—s	650	11		53	0.360	0.400	22	10			
		New R6509KNX	—s	650	9		48	0.530	0.585	16.5	10			
		New R6507KNX	—s	650	7		46	0.605	0.665	15	10			
		New R6504KNX	—s	650	4		35	0.955	1.050	10	10			
		R8010ANX	—	800	10		40	0.430	0.560	62	10			
		R8008ANX	—	800	8		50	0.790	1.030	39	10			
		R8005ANX	—	800	5		40	1.600	2.080	21	10			
R8002ANX	—	800	2	35	3.300	4.300	12.7	10						
TO-220AB 		New R6535KNX1	C10	N	650	35	102	0.098	0.115	72	10			
		New R6530KNX1	C10		650	30	86	0.125	0.140	56	10			
		New R6524KNX1	C10		650	24	74	0.160	0.185	45	10			
		New R6520KNX1	C10		650	20	68	0.185	0.205	40	10			
		New R6515KNX1	C10		650	15	60	0.280	0.315	27.5	10			
TO-3PF 		R6035KNZ	C8	N	600	35	102	0.095	0.102	72	10			
		R6030KNZ	C8		600	30	86	0.115	0.130	56	10			
		R6024KNZ	C8		600	24	74	0.150	0.165	46	10			
		R6020KNZ	C8		600	20	68	0.170	0.196	40	10			
		R6015KNZ	C8		600	15	60	0.260	0.290	30	10			
		New R6535KNZ	C8		650	35	102	0.098	0.115	72	10			
		New R6530KNZ	C8		650	30	86	0.125	0.140	56	10			
		New R6524KNZ	C8		650	24	74	0.160	0.185	46	10			
		New R6520KNZ	C8		650	20	68	0.185	0.205	40	10			
		New R6515KNZ	C8		650	15	60	0.280	0.315	30	10			
TO-247 		New R6076KNZ1	C9	N	600	76	735	0.040	0.042	165	10			
		New R6047KNZ1	C9		600	47	481	0.070	0.072	100	10			
		R6035KNZ1	C9		600	35	379	0.095	0.102	72	10			
		R6030KNZ1	C9		600	30	305	0.115	0.130	56	10			
		R6024KNZ1	C9		600	24	245	0.150	0.165	46	10			
		R6020KNZ1	C9		600	20	231	0.170	0.196	40	10			
		New R6576KNZ1	C9		650	76	735	0.040	0.046	165	10			
		New R6547KNZ1	C9		650	47	481	0.070	0.080	100	10			
		New R6535KNZ1	C9		650	35	379	0.098	0.115	72	10			
		New R6530KNZ1	C9		650	30	305	0.125	0.140	56	10			
		New R6524KNZ1	C9		650	24	245	0.160	0.185	45	10			
		New R6520KNZ1	C9		650	20	231	0.185	0.205	40	10			
		SOP8(Dual) 			SP8K80	TB1	N+N	500	0.5	2	9.000	11.700	3.8	10

Notes1 : Package is JEDEC code. () : ROHM Packages, [] : JEITA code
Notes2 : *: Packaging type C7 allows the tube.

☆: Under Development

Power MOSFETs

Fast Recovery Body Diode Type (PrestoMOS™)															
Package	Application	Product No.		Polarity (ch)	V _{DSS} (V)	I _D (A)	P _D (W) (T _C =25°C)	R _{DS(on)} (Ω)				Q _g Typ.(nC)		t _{rr} (Typ.) (ns)	Drive Voltage (V)
		Part No.	Taping Code					V _{GS} =10V		V _{GS} =15V		V _{GS} =10V	V _{GS} =15V		
								Typ.	Max.	Typ.	Max.				
TO-252		New R6010MND3	TL	N	600	10	143	0.280	0.380	—	—	20	—	80	10
		☆R6008MND3	TL		600	8	115	0.450	0.610	—	—	13.5	—	65	10
		New R6007MND3	TL		600	7	95	0.540	0.730	—	—	10	—	60	10
		☆R6009JND3	TL1		600	9	125	—	—	0.450	0.585	—	22	65	15
		☆R6007JND3	TL1		600	7	96	—	—	0.600	0.780	—	17.5	60	15
		☆R6006JND3	TL1		600	6	86	—	—	0.720	0.936	—	15.5	58	15
		☆R6005JND3	TL1		600	5	70	—	—	0.930	1.209	—	12.5	55	15
		☆R6004JND3	TL1		600	4	60	—	—	1.100	1.430	—	10.5	45	15
TO-263S (LPTS D2PAK) [SC-83]		☆R6010MNJ	TL	N	600	10	143	0.280	0.380	—	—	20	—	80	10
		☆R6008MNJ	TL		600	8	113	0.450	0.610	—	—	13.5	—	65	10
		☆R6007MNJ	TL		600	7	94	0.540	0.730	—	—	10	—	60	10
		☆R6020JNJ	TL		600	20	252	—	—	0.200	0.260	—	50	85	15
		☆R6018JNJ	TL		600	18	220	—	—	0.220	0.286	—	42	80	15
		☆R6012JNJ	TL		600	12	160	—	—	0.350	0.455	—	30	70	15
		☆R6009JNJ	TL		600	9	125	—	—	0.450	0.585	—	22	65	15
		☆R6007JNJ	TL		600	7	96	—	—	0.600	0.780	—	17.5	60	15
		☆R6006JNJ	TL		600	6	86	—	—	0.720	0.936	—	15.5	58	15
		☆R6005JNJ	TL		600	5	70	—	—	0.930	1.209	—	12.5	55	15
		☆R6004JNJ	TL		600	4	60	—	—	1.100	1.430	—	10.5	45	15
		TO-220FM	Switching		New R6030MNX	—*	N	600	30	90	0.110	0.150	—	—	43
☆R6010MNX	—*			600	10	56		0.280	0.380	—	—	20	—	80	10
☆R6008MNX	—*			600	8	50		0.450	0.610	—	—	13.5	—	65	10
☆R6007MNX	—*			600	7	45		0.540	0.730	—	—	10	—	60	10
☆R6025JNX	—*			600	25	85		—	—	0.150	0.195	—	65	90	15
☆R6020JNX	—*			600	20	76		—	—	0.200	0.260	—	50	85	15
☆R6018JNX	—*			600	18	72		—	—	0.220	0.286	—	42	80	15
☆R6012JNX	—*			600	12	60		—	—	0.350	0.455	—	30	70	15
☆R6009JNX	—*			600	9	53		—	—	0.450	0.585	—	22	65	15
☆R6007JNX	—*			600	7	46		—	—	0.600	0.780	—	17.5	60	15
☆R6006JNX	—*			600	6	43		—	—	0.720	0.936	—	15.5	58	15
☆R6005JNX	—*			600	5	40		—	—	0.930	1.209	—	12.5	55	15
☆R6004JNX	—*			600	4	35		—	—	1.100	1.430	—	10.5	45	15
TO-3PF				New R6047MNZ	C8	N		600	47	102	0.060	0.081	—	—	70
		New R6030MNZ	C8	600	30		90	0.110	0.150	—	—	43	—	90	10
		☆R6030JNZ	C8	600	30		93	—	—	0.120	0.156	—	75	95	15
		☆R6025JNZ	C8	600	25		85	—	—	0.150	0.195	—	65	90	15
		☆R6020JNZ	C8	600	20		76	—	—	0.200	0.260	—	50	85	15
TO-247		New R6076MNZ1	C9	N	600	76	740	0.040	0.055	—	—	115	—	135	10
		New R6047MNZ1	C9		600	47	440	0.060	0.081	—	—	70	—	105	10
		New R6030MNZ1	C9		600	30	357	0.110	0.150	—	—	43	—	90	10
		☆R6070JNZ1	C9		600	70	770	—	—	0.050	0.065	—	160	135	15
		☆R6042JNZ1	C9		600	42	495	—	—	0.090	0.117	—	100	110	15
		☆R6030JNZ1	C9		600	30	370	—	—	0.120	0.156	—	75	95	15
		☆R6025JNZ1	C9		600	25	306	—	—	0.150	0.195	—	65	90	15
☆R6020JNZ1	C9	600	20	252	—	—	0.200	0.260	—	50	85	15			

Notes1 : Package is JEDEC code. () :ROHM Packages, [] :JEITA code
Notes2 : *: Packaging type C7 allows the tube.

☆: Under Development

Selector Guide for Automotive Power MOSFETs

Automotive Power MOSFETs																	
Package	Product No.			Polarity (ch)	V _{DSS} (V)	I _D (A)	V _{GS} (V)	R _{DS(on)} (mΩ)						Qg Typ.(nC)	Ciss Typ.(pF)	Automotive Grade AEC-Q101	
	Part No.	Grade Code	Taping Code					V _{GS} =10V		V _{GS} =4.5V		V _{GS} =2.5V					
								Typ.	Max.	Typ.	Max.	Typ.	Max.				
<p>SOT-89 (MPT3) [SC-62] 4540 size</p>	RHP030N03	FRA	T100	N	30	3	±20	90	120	160	210	—	—	6.5*1	160	YES	
	RJP020N06	FRA	T100		60	2	±12	—	—	165	240	210	300	5*2	160	YES	
	RHP020N06	FRA	T100		60	2	±20	150	200	200	280	—	—	7*1	140	YES	
<p>(HSMT8AG) 3333 size</p>	☆AG009DGQ3	—	TB	N	40	30	±20	6	8	7.3	10	—	—	32*1	1790	YES	
<p>(SOP8) 5060 size</p>	RSS130N03	FRA	TB	N	30	13	±20	5.9	8.3	7.4	10.4	—	—	25	2000	YES	
	RSS100N03	FRA	TB		30	10	±20	9.5	13.3	12.5	17.5	—	—	14	1070	YES	
	RSS090N03	FRA	TB		30	9	±20	11	16	15	22	—	—	11	810	YES	
	RSS095N05	FRA	TB		45	9.5	±20	11	16	14	20	—	—	18.9	1830	YES	
	RSS070N05	FRA	TB		45	7	±20	18	25	23	32	—	—	12	1000	YES	
	RSS065N06	FRA	TB		60	6.5	±20	24	37	28	44	—	—	11	900	YES	
	SP8K3	FRA	TB	30	7	±20	17	24	23	33	—	—	8.4	600	YES		
	SP8K2	FRA	TB	30	6	±20	21	30	30	42	—	—	7.2	520	YES		
	SP8K1	FRA	TB	30	5	±20	36	51	52	73	—	—	3.9	230	YES		
	SP8K5	FRA	TB	30	3.5	±20	59	83	93	130	—	—	2.5	140	YES		
	SP8K24	FRA	TB	45	6	±20	18	25	24	34	—	—	15.4	1400	YES		
	SP8K23	FRA	TB	45	5	±20	26	36	33	46	—	—	8.6	700	YES		
	SP8K22	FRA	TB	45	4.5	±20	33	46	41	57	—	—	6.8	550	YES		
	SP8K33	FRA	TB	60	5	±20	34	48	38	54	—	—	8	620	YES		
	SP8K32	FRA	TB	60	4.5	±20	46	65	52	73	—	—	7	500	YES		
	SP8K31	FRA	TB	60	3.5	±20	85	120	100	140	—	—	3.7	250	YES		
	SP8K41	FRA	TB	80	3.4	±20	90	130	110	150	120	160	6.6	600	YES		
	SP8K52	FRA	TB	100	3	±20	120	170	130	180	—	—	8.5	610*3	YES		
	RRS140P03	FRA	TB	-30	-14	±20	5	7	6.7	9.4	—	—	80	8000	YES		
	RRS100P03	FRA	TB	-30	-10	±20	9	12.6	12.5	17.5	—	—	39	3600	YES		
	RRS090P03	FRA	TB	-30	-9	±20	11	15.4	15	21	—	—	30	3000	YES		
	RRS075P03	FRA	TB	-30	-7.5	±20	15	21	22	31	—	—	21	1900	YES		
	RRS050P03	FRA	TB	-30	-5	±20	36	50	52	72	—	—	9.2	850	YES		
	RRS040P03	FRA	TB	-30	-4	±20	55	75	85	115	—	—	5.2	480	YES		
	RSS070P05	FRA	TB	-45	-7	±20	19	27	25	35	—	—	34	4100	YES		
	RSS060P05	FRA	TB	-45	-6	±20	26	36	35	49	—	—	23	2700	YES		
	SP8J66	FRA	TB	-30	-9	±20	13.5	18.5	17.5	23.6	—	—	35	3000	YES		
	SP8J5	FRA	TB	-30	-7	±20	20	28	25	35	—	—	25	2600	YES		
	SP8M4	FRA	TB	30	9	±20	12	18	16	24	—	—	15	1190	YES		
	<td>SP8M10</td> <td>FRA</td> <td>TB</td> <td>-30</td> <td>-7</td> <td>±20</td> <td>20</td> <td>28</td> <td>25</td> <td>35</td> <td>—</td> <td>—</td> <td>25</td> <td>2600</td> <td>YES</td>	SP8M10	FRA	TB	-30	-7	±20	20	28	25	35	—	—	25	2600	YES	
		<td>SP8M5</td> <td>FRA</td> <td>TB</td> <td>30</td> <td>7</td> <td>±20</td> <td>17</td> <td>25</td> <td>23</td> <td>35</td> <td>—</td> <td>—</td> <td>8.4</td> <td>600</td> <td>YES</td>	SP8M5	FRA	TB	30	7	±20	17	25	23	35	—	—	8.4	600	YES
			-30	-4.5	±20	40	56	57	80	—	—	8.5	850	YES			
		<td>SP8M8</td> <td>FRA</td> <td>TB</td> <td>30</td> <td>6</td> <td>±20</td> <td>21</td> <td>30</td> <td>30</td> <td>42</td> <td>—</td> <td>—</td> <td>7.2</td> <td>520</td> <td>YES</td>	SP8M8	FRA	TB	30	6	±20	21	30	30	42	—	—	7.2	520	YES
-30			-4.5	±20	40	56	57	80	—	—	8.5	850	YES				
<td>SP8M3</td> <td>FRA</td> <td>TB</td> <td>30</td> <td>5</td> <td>±20</td> <td>36</td> <td>51</td> <td>52</td> <td>73</td> <td>—</td> <td>—</td> <td>3.9</td> <td>230</td> <td>YES</td>		SP8M3	FRA	TB	30	5	±20	36	51	52	73	—	—	3.9	230	YES	
		-30	-4.5	±20	40	56	57	80	—	—	8.5	850	YES				
<td>SP8M6</td> <td>FRA</td> <td>TB</td> <td>30</td> <td>5</td> <td>±20</td> <td>36</td> <td>51</td> <td>52</td> <td>73</td> <td>—</td> <td>—</td> <td>3.9</td> <td>230</td> <td>YES</td>		SP8M6	FRA	TB	30	5	±20	36	51	52	73	—	—	3.9	230	YES	
		-30	-3.5	±20	65	90	100	140	—	—	5.5	490	YES				
<td>SP8M21</td> <td>FRA</td> <td>TB</td> <td>45</td> <td>6</td> <td>±20</td> <td>18</td> <td>25</td> <td>24</td> <td>34</td> <td>—</td> <td>—</td> <td>15.4</td> <td>1400</td> <td>YES</td>		SP8M21	FRA	TB	45	6	±20	18	25	24	34	—	—	15.4	1400	YES	
		-45	-4	±20	33	46	43	60	—	—	20	2400	YES				
<td>SP8M24</td> <td>FRA</td> <td>TB</td> <td>45</td> <td>4.5</td> <td>±20</td> <td>33</td> <td>46</td> <td>41</td> <td>57</td> <td>—</td> <td>—</td> <td>6.8</td> <td>550</td> <td>YES</td>		SP8M24	FRA	TB	45	4.5	±20	33	46	41	57	—	—	6.8	550	YES	
	-45	-3.5	±20	45	63	60	84	—	—	13	1700	YES					
<td>SP8M41</td> <td>FRA</td> <td>TB</td> <td>80</td> <td>3.4</td> <td>±20</td> <td>90</td> <td>130</td> <td>110</td> <td>150</td> <td>—</td> <td>—</td> <td>6.6</td> <td>600</td> <td>YES</td>	SP8M41	FRA	TB	80	3.4	±20	90	130	110	150	—	—	6.6	600	YES		
	-80	-2.6	±20	165	240	220	300	—	—	8.2	1000	YES					
<td>SP8M51</td> <td>FRA</td> <td>TB</td> <td>100</td> <td>3</td> <td>±20</td> <td>120</td> <td>170</td> <td>130</td> <td>180</td> <td>—</td> <td>—</td> <td>8.5</td> <td>610*3</td> <td>YES</td>	SP8M51	FRA	TB	100	3	±20	120	170	130	180	—	—	8.5	610*3	YES		
	-100	-2.5	±20	210	290	230	320	—	—	12.5	1550*3	YES					

Notes1 : Package is JEDEC code. () :ROHM Packages, [] :JEITA code
Notes2 : *1: V_{GS}=10V *2: V_{GS}=4.0V *3: V_{GS}=25V

☆: Under Development

Selector Guide for Automotive Power MOSFETs

Automotive Power MOSFETs															
Package	Product No.			Polarity (ch)	V _{DSS} (V)	I _b (A)	V _{GS} (V)	R _{DS(on)} (mΩ)				Q _g Typ.(nC)	Ciss Typ.(pF)	Automotive Grade AEC-Q101	
	Part No.	Grade Code	Taping Code					V _{GS} =10V		V _{GS} =4.5V		V _{GS} =10V	V _{DS} =10V		
								Typ.	Max.	Typ.	Max.				
 TO-252	☆RD3H200SN	FRA	TL	N	45	20	±20	20	28	25	35	12*1	950	YES	
	☆RD3L220SN	FRA	TL		60	22	±20	18	26	21	30	30	1500	YES	
	☆RD3L150SN	FRA	TL		60	15	±20	28	40	33	47	18	930	YES	
	☆RD3L080SN	FRA	TL		60	8	±20	57	80	70	98	9.4	380	YES	
	☆RD3L050SN	FRA	TL		60	5	±20	78	109	94	131	8	290	YES	
	☆RD3P200SN	FRA	TL		100	20	±20	33	46	36*3	50*3	55	2100*2	YES	
	☆RD3P175SN	FRA	TL		100	17.5	±20	75	105	80	112	24	950*2	YES	
	☆RD3P100SN	FRA	TL		100	10	±20	95	133	100	140	18	700*2	YES	
	☆RD3P050SN	FRA	TL		100	5	±20	135	190	142	200	14	530*2	YES	
	☆RD3U080AA	FRA	TL		250	8	±30	225	300	—	—	—	1440*2	YES	
	☆RD3U041AA	FRA	TL		250	4	±30	930	1300	—	—	—	350*2	YES	
	☆R5205PND3	FRA	TL		525	5	±25	1300	1600	—	—	—	320*2	YES	
	☆R6006PND3	FRA	TL		600	6	±30	900	1200	—	—	—	460*2	YES	
	☆R6004PND3	FRA	TL		600	4	±25	1400	1800	—	—	—	280*2	YES	
	☆R8002CND3	FRA	TL		800	2	±30	3300	4300	—	—	—	240*2	YES	
	☆R8001CND3	FRA	TL		800	1	±30	6700	8700	—	—	—	60*2	YES	
	☆RD3H160SP	FRA	TL		P	-45	-16	±20	35	50	45	63	16*1	2000	YES
	☆RD3H080SP	FRA	TL			-45	-8	±20	65	91	95	133	9*1	1000	YES
	☆RD3H045SP	FRA	TL	-45		-4.5	±20	110	155	160	225	12*1	550	YES	
	☆RD3L140SP	FRA	TL	-60		-14	±20	60	84	73	103	27	1900	YES	
☆RD3P130SP	FRA	TL	-100	-13		±20	135	200	150	220	40	2400*3	YES		
☆RSJ451N04	FRA	TL	40	45		±20	9.5	13.5	—	—	43	2400*2	YES		
☆RSJ400N06	FRA	TL	60	40	±20	11	16	—	—	52	2400	YES			
☆RSJ400N10	FRA	TL	100	40	±20	19	27	21*3	30*3	90	3600*2	YES			
☆RSJ301N10	FRA	TL	100	30	±20	33	46	36*3	50*3	60	2100*2	YES			
☆RJ1U330AA	FRG	TL	250	33	±30	77	105	—	—	80	4500*2	YES			
☆R6020PNJ	FRG	TL	600	20	±30	190	250	—	—	65	2040*2	YES			
☆R8008ANJ	FRG	TL	800	8	±30	790	1030	—	—	38	1100*2	YES			
☆R8005ANJ	FRG	TL	800	5	±30	1600	2100	—	—	20	500*2	YES			
☆R8002ANJ	FRG	TL	800	2	±30	3300	4300	—	—	13	250*2	YES			
☆RSJ250P10	FRA	TL	P	-100	-25	±20	45	63	48	67	60*1	8000*2	YES		

Notes1 : Package is JEDEC code. () :ROHM Packages, []:JEITA code
Notes2 : *1: V_{GS}=5V *2: V_{GS}=25V *3: V_{GS}=4.0V

☆: Under Development

Bipolar Transistors

Quick Reference for General Purpose Amplification Bipolar Transistors(Flat type)									
Package	SOT-723 (VMT3) [SC-105AA] 1212 size		SOT-416FL (EMT3F) [SC-89] 1616 size		SOT-323FL (UMT3F) [SC-85] 2021 size		V _{CEO} (V)	I _C (A)	h _{FE} *2
	Polarity	P _D =0.15W		P _D =0.15W		P _D =0.2W			
Application	PNP	NPN	PNP	NPN	PNP	NPN			
General Purpose Amplification	2SAR522M	2SCR522M	2SAR522EB	2SCR522EB	2SAR522UB	2SCR522UB	20	0.2	120 to 560
	2SAR523M	2SCR523M	2SAR523EB	2SCR523EB	2SAR523UB	2SCR523UB	50	0.1	120 to 560
Low V _{CE(sat)}	2SA2029	2SC5658	2SA1774EB	2SC4617EB	2SA1576UB	2SC4081UB	50	0.15	120 to 560
	2SA2030	2SC5663					12	0.5	270 to 680
V _{CE(sat)} Driver		2SD2696					30	0.4	270 to 680
			2SAR502EB	2SCR502EB	2SAR502UB	2SCR502UB	30	0.5	200 to 500

Notes1 : *1 With reference land installed
 Notes2 : *2 For h_{FE}, please see the technical specifications.
 Notes3 : PNP (-) symbol omitted.
 Notes4 : Package is JEDEC code. () :ROHM Packages, [] :JEITA code

General Purpose Amplification Bipolar Transistors(Flat type)														
Package	Application	Product No.					Polarity (ch)	P _D *1 (W)	V _{CEO} (V)	I _C (A)	h _{FE} *2			Automotive Grade AEC-Q101
		Part No.	Grade Code		Taping Code	h _{FE} *2 Code								
General	Automotive													
SOT-723 (VMT3) [SC-105AA] 1212 size	General Purpose Amplification	2SAR522M	—	—	T2L				0.15	20	0.2	120 to 560		—
		2SAR523M	—	—	T2L				0.15	50	0.1	120 to 560		—
		2SA2029	FHA	—	T2L	Q	R	S	0.15	50	0.15	120 to 560	S:Not Recommended	YES
		2SA2030	—	—	T2L				0.15	12	0.5	270 to 680		—
	Low V _{CE(sat)}	2SCR522M	—	—	T2L				0.15	20	0.2	120 to 560		—
		2SCR523M	—	—	T2L				0.15	50	0.1	120 to 560		—
		2SC5658	FHA	—	T2L	Q	R	S	0.15	50	0.15	120 to 560	S:Not Recommended	YES
		2SC5663	—	—	T2L				0.15	12	0.5	270 to 680		—
SOT-416FL (EMT3F) [SC-89] 1616 size	General Purpose Amplification	2SAR522EB	—	—	TL				0.15	20	0.2	120 to 560		—
		2SAR523EB	—	—	TL				0.15	50	0.1	120 to 560		—
		2SA1774EB	HZG	—	TL	Q	R	S	0.15	50	0.15	120 to 560	S:Not Recommended	YES
		2SAR502EB	HZG	—	TL				0.15	30	0.5	200 to 500		YES
	Driver	2SCR522EB	—	—	TL				0.15	20	0.2	120 to 560		—
		2SCR523EB	—	—	TL				0.15	50	0.1	120 to 560		—
		2SC4617EB	HZG	—	TL	Q	R	S	0.15	50	0.15	120 to 560	S:Not Recommended	YES
		2SCR502EB	HZG	—	TL				0.15	30	0.5	200 to 500		YES
SOT-323FL (UMT3F) [SC-85] 2021 size	General Purpose Amplification	2SAR522UB	—	—	TL				0.2	20	0.2	120 to 560		—
		2SAR523UB	—	—	TL				0.2	50	0.1	120 to 560		—
		2SA1576UB	HZG	—	TL	Q	R	S	0.2	50	0.15	120 to 560	S:Not Recommended	YES
		2SAR502UB	HZG	—	TL				0.2	30	0.5	200 to 500		YES
	Driver	2SCR522UB	—	—	TL				0.2	20	0.2	120 to 560		—
		2SCR523UB	—	—	TL				0.2	50	0.1	120 to 560		—
		2SC4081UB	HZG	—	TL	Q	R	S	0.2	50	0.15	120 to 560	S:Not Recommended	YES
		2SCR502UB	HZG	—	TL				0.2	30	0.5	200 to 500		YES

Notes1 : *: General Part No. have no grade code.
 Notes2 : *1 With reference land installed
 Notes3 : *2 For h_{FE}, Q: 120 to 270, R: 180 to 390, S: 270 to 560. Please see the technical specifications.
 Notes4 : PNP (-) symbol omitted.
 Notes5 : Package is JEDEC code. () :ROHM Packages, [] :JEITA code

Quick Reference for General Purpose Amplification Bipolar Transistors(Gull type)											
Package	SOT-416 (EMT3) [SC-75A] 1616 size		SOT-323 (UMT3) [SC-70] 2021 size		SOT-346 (SMT3) [SC-59] 2928 size		SOT23 (SST3) 2924 size		V _{CEO} (V)	I _C (A)	h _{FE} *2
	Polarity	P _D =0.15W		P _D =0.2W		P _D =0.2W		P _D =0.2W			
Application	PNP	NPN	PNP	NPN	PNP	NPN	PNP	NPN			
General Purpose Amplification			☆2SAR502U3	☆2SCR502U3					30	0.5	200 to 500
			☆2SA1576U3	☆2SC4081U3					50	0.15	120 to 560
Low V _{CE(sat)}	2SA1774	2SC4617	2SA1576A	2SC4081	2SA1037AK	2SC2412K			50	0.15	120 to 560
	2SA2018	2SC5585			2SA2119K				12	0.5	270 to 680
Drive					2SD1757K				15	0.5	120 to 560
					2SB1590K	2SD2444K			15	1	120 to 270 180 to 390
			2SB1689	2SD2652					12	1.5	270 to 680
			2SB1694	2SD2656	2SB1690K	2SD2653K			12	2	270 to 680
					2SB1695K	2SD2657K			30	1	270 to 680
			2SA1577	2SC4097	2SA1036K	2SC2411K			30	1.5	270 to 680
High Speed Switching					2SB1197K	2SD1781K			32	0.5	120 to 390
				2SD1949	2SB1197K	2SD1781K			32	0.8	120 to 390
					2SB1198K	2SD1782K			50	0.5	120 to 390
High Voltage			☆2SA2088U3						80	0.5	120 to 390
				☆2SC5876U3					60	0.5	120 to 270
			2SA2088	2SC5876					60	0.5	120 to 390
High Voltage			☆2SA1579U3	☆2SC4102U3			☆2SARA41C	☆2SCRC41C	120	0.05	180 to 560
			2SA1579	2SC4102	2SA1514K	2SC3906K			120	0.05	180 to 560
					2SC4061K				300	0.1	56 to 120

Notes1 : *1 With reference land installed
 Notes2 : *2 For h_{FE}, please see the technical specifications.
 Notes3 : PNP (-) symbol omitted.
 Notes4 : Package is JEDEC code. () :ROHM Packages, [] :JEITA code
 ☆: Under Development

General Purpose Amplification Bipolar Transistors(Gull type)															
Package	Application	Part No.	Product No.					Polarity (ch)	P _D *1 (W)	V _{CE0} (V)	I _c (A)	h _{FE} *2		Automotive Grade AEC-Q101	
			Grade Code		Taping Code	h _{FE} *2 Code									
		General		Automotive											
 SOT-416 (EMT3) [SC-75A] 1616 size	General Purpose Amplification	2SA1774	*	FRA	TL	Q	R	S	PNP	0.15	50	0.15	120 to 560	S:Not Recommended	YES
	Low V _{CE(sat)}	2SA2018	*	—	TL				PNP	0.15	12	0.5	270 to 680		—
	General Purpose Amplification	2SC4617	*	FRA	TL	Q	R	S	NPN	0.15	50	0.15	120 to 560		YES
	Low V _{CE(sat)}	2SC5585	*	—	TL				NPN	0.15	12	0.5	270 to 680		—
 SOT-323 (UMT3) [SC-70] 2021 size	General Purpose Amplification	☆2SAR502U3	*	HZG	T106				PNP	0.2	30	0.5	200 to 500		YES
		☆2SA1576U3	*	HZG	T106					0.2	50	0.15	120 to 560		YES
		2SA1576A	*	FRA	T106	Q	R	S		0.2	50	0.15	120 to 560	S:Not Recommended	YES
	Low V _{CE(sat)}	2SB1689	*	—	T106					0.2	12	1.5	270 to 680		—
		2SB1694	*	FRA	T106					0.2	30	1	270 to 680		YES
	Driver	2SA1577	*	—	T106	Q	R			0.2	32	0.5	120 to 390		—
	High Speed Switching	☆2SA2088U3	*	HZG	T106					0.2	60	0.5	120 to 270		YES
		2SA2088	*	FRA	T106	Q				0.2	60	0.5	120 to 390		YES
	High Voltage	☆2SA1579U3	*	HZG	T106					0.2	120	0.05	180 to 560		YES
		2SA1579	*	FRA	T106	R	S			0.2	120	0.05	180 to 560		YES
	General Purpose Amplification	☆2SCR502U3	*	HZG	T106				NPN	0.2	30	0.5	200 to 500		YES
		☆2SC4081U3	*	HZG	T106					0.2	50	0.15	120 to 560		YES
		2SC4081	*	FRA	T106	Q	R	S		0.2	50	0.15	120 to 560	S:Not Recommended	YES
	Low V _{CE(sat)}	2SD2652	*	—	T106					0.2	12	1.5	270 to 680		—
		2SD2656	*	FRA	T106					0.2	30	1	270 to 680		YES
	Driver	2SC4097	*	—	T106	Q	R			0.2	32	0.5	120 to 390		—
		2SD1949	*	—	T106	Q	R			0.2	50	0.5	120 to 390		—
	High Speed Switching	☆2SC5876U3	*	HZG	T106					0.2	60	0.5	120 to 390		YES
		2SC5876	*	FRA	T106	Q	R			0.2	60	0.5	120 to 390		YES
	High Voltage	☆2SC4102U3	*	HZG	T106					0.2	120	0.05	180 to 560		YES
	2SC4102	*	FRA	T106	R	S		0.2	120	0.05	180 to 560		YES		
 SOT-346 (SMT3) [SC-59] 2928 size	General Purpose Amplification	2SA1037AK	*	FRA	T146	Q	R	S	PNP	0.2	50	0.15	120 to 560	S:Not Recommended	YES
		2SA2119K	*	—	T146					0.2	12	0.5	270 to 680		—
	Low V _{CE(sat)}	2SB1590K	*	—	T146	Q				0.2	15	1	120 to 390		—
		2SB1690K	*	—	T146					0.2	12	2	270 to 680		—
		2SB1695K	*	—	T146					0.2	30	1.5	270 to 680		—
	Driver	2SA1036K	*	FRA	T146	Q	R			0.2	32	0.5	120 to 390		YES
		2SB1197K	*	FRA	T146	Q	R		0.2	32	0.8	120 to 390		YES	
		2SB1198K	*	FRA	T146	Q	R		0.2	80	0.5	120 to 390		YES	
	High Voltage	2SA1514K	*	FRA	T146	R	S		0.2	120	0.05	180 to 560		YES	
	General Purpose Amplification	2SC2412K	*	FRA	T146	Q	R	S	NPN	0.2	50	0.15	120 to 560	S:Not Recommended	YES
		2SD1757K	*	—	T146	Q	R	S		0.2	15	0.5	120 to 560		—
	Low V _{CE(sat)}	2SD2444K	*	—	T146	R				0.2	15	1	180 to 390		—
		2SD2653K	*	—	T146					0.2	12	2	270 to 680		—
		2SD2657K	*	—	T146					0.2	30	1.5	270 to 680		—
	Driver	2SC2411K	*	FRA	T146	Q	R			0.2	32	0.5	120 to 390		YES
		2SD1781K	*	FRA	T146	Q	R			0.2	32	0.8	120 to 390		YES
		2SD1484K	*	FRA	T146	Q	R			0.2	50	0.5	120 to 390		YES
		2SD1782K	*	FRA	T146	Q	R			0.2	80	0.5	120 to 390		YES
High Voltage	2SC3906K	*	FRA	T146	R	S		0.2		120	0.05	180 to 560		YES	
	2SC4061K	*	—	T146	N			0.2	300	0.1	56 to 120		—		
 SOT23 (SST3) 2924 size	High Voltage	☆2SARA41C	*	HZG	T116	R	S		PNP	0.2	120	0.05	180 to 560		YES
		☆2SCRC41C	*	HZG	T116	R	S		NPN	0.2	120	0.05	180 to 560		YES

Notes1 : *: General Part No. have no grade code.
 Notes2 : *1 With reference land installed
 Notes3 : *2 For h_{FE}, N: 56 to 120, P: 82 to 180, Q: 120 to 270, R: 180 to 390, S: 270 to 560. Please see the technical specifications.
 Notes4 : PNP (—) symbol omitted.
 Notes5 : Package is JEDEC code. () :ROHM Packages, [] :JEITA code

☆: Under Development

Bipolar Transistors

Quick Reference for Bipolar Transistors(For Oversea Customer)									
Package	SOT-323 (UMT3) [SC-70] 2021 size		SOT-363 (UMT6) [SC-88] 2021 size		SOT-23 (SST3) 2924 size		V _{CEO} (V)	I _c (A)	h _{FE} *2
Polarity	P _D =0.15W		P _D =0.2W		P _D =0.2W				
Application	PNP	NPN	PNP/NPN		PNP	NPN			
General Purpose Amplification	BC858BW	BC848BW			BC858B	BC848B	30	0.1	200 to 450
	☆BC857BU3	☆BC847BU3			BC857B	BC847B	45	0.1	200 to 450
							45	0.1	210 to 480
			☆BC846PN		☆BC857C	☆BC847C	45	0.15	420 to 800
Driver						☆BC846B	65	0.12	200 to 450
					BC856B		65	0.1	220 to 475
					☆BSS63	☆BSS64	100	0.1	30 or more
					☆BSS4130	☆BSS5130	30	1.0	270 or more
					BCX17	BCX19	45	0.5	100 to 600
					BC807-16	BC817-16	45	0.8	100 to 250
					BC807-25	BC817-25	45	0.8	160 to 400
					BC807-40	BC817-40	45	0.8	250 to 600
Switching	UMT3906	UMT3904			SST3906	SST3904	40	0.2	100 to 300
	☆UMT4403U3	☆UMT4401U3			SST4403	SST4401	40	0.6	100 to 300
		UMT2222A				SST2222A	40	0.6	100 to 300
		☆UM2222AU3					40	0.6	100 to 300
	UMT2907A				SST2907A		60	0.6	100 to 300
Darlington*3					SSTA28	80 (V _{CEs})	0.3	10k or more	

Notes1 : *1 With reference land installed Notes2 : *2 For h_{FE}, please see the technical specifications.
Notes3 : *3 For internal circuit, please see the technical specifications.
Notes4 : PNP (-) symbol omitted.
Notes5 : Package is JEDEC code. ():ROHM Packages, []:JEITA code

☆: Under Development

Bipolar Transistors(For Oversea Customer)													
Package	Application	Product No.			Polarity (ch)	P _D *1 (W)	V _{CEO} (V)	I _c (A)	h _{FE} *2	Automotive Grade AEC-Q101			
		Part No.	Grade Code								Taping Code		
			General	Automotive									
 SOT-323 (UMT3) [SC-70] 2021 size	General Purpose Amplification	BC858BW		—	T106	PNP	0.15	30	0.1	200 to 450	—		
		☆BC857BU3		HZG	T106		0.15	45	0.1	210 to 480	YES		
	Switching	UMT3906		—	T106		0.15	40	0.2	100 to 300	—		
		☆UMT4403U3		HZG	T106		0.15	40	0.6	100 to 300	YES		
		UMT2907A		—	T106		0.15	60	0.6	100 to 300	—		
	General Purpose Amplification	BC848BW	*	—	T106		NPN	0.15	30	0.1	200 to 450	—	
		☆BC847BU3		HZG	T106			0.15	45	0.1	200 to 450	YES	
		UMT3904		—	T106			0.15	40	0.2	100 to 300	—	
		☆UMT4401U3		HZG	T106			0.15	40	0.6	100 to 300	YES	
		UMT2222A		—	T106			0.15	40	0.6	100 to 300	—	
☆UM2222AU3		HZG	T106	0.15	40	0.6	100 to 300	YES					
 SOT-363 (UMT6) [SC-88] 2021 size	General Purpose Amplification	☆BC846PN	*	FHA	TR	NPN/PNP	0.2	65	0.12	200 to 450	YES		
 SOT-23 (SST3) 2924 size	General Purpose Amplification	BC858B		HZG	T116	PNP	0.2	30	0.1	200 to 450	YES		
		BC857B		HZG	T116		0.2	45	0.1	200 to 450	YES		
		☆BC857C		HZG	T116		0.2	45	0.15	420 to 800	YES		
		BC856B		HZG	T116		0.2	65	0.1	220 to 475	YES		
		☆BSS63		HZG	T116		0.2	100	0.1	30 or more	YES		
	Driver	☆BSS4130		HZG	T116		0.2	30	1.0	270 or more	YES		
		BCX17		HZG	T116		0.2	45	0.5	100 to 600	YES		
		BC807-16		HZG	T116		0.2	45	0.8	100 to 250	YES		
		BC807-25		HZG	T116		0.2	45	0.8	160 to 400	YES		
		BC807-40		HZG	T116		0.2	45	0.8	250 to 600	YES		
		SSTA56		HZG	T116		0.2	80	0.5	100 or more	YES		
		SST3906		HZG	T116		0.2	40	0.2	100 to 300	YES		
		SST4403		HZG	T116		0.2	40	0.6	100 to 300	YES		
		SST2907A		HZG	T116		0.2	60	0.6	100 to 300	YES		
		BC848B		HZG	T116		0.2	30	0.1	200 to 450	YES		
	General Purpose Amplification	BC847B	*	HZG	T116		NPN	0.2	45	0.1	200 to 450	YES	
		☆BC847C		HZG	T116			0.2	45	0.15	420 to 800	YES	
		☆BC846B		HZG	T116			0.2	65	0.12	200 to 450	YES	
		☆BSS64		HZG	T116			0.2	100	0.1	30 or more	YES	
		☆BSS5130		HZG	T116			0.2	30	1.0	270 or more	YES	
		BCX19		HZG	T116			0.2	45	0.5	100 to 600	YES	
		BC817-16		HZG	T116			0.2	45	0.8	100 to 250	YES	
		BC817-25		HZG	T116			0.2	45	0.8	160 to 400	YES	
		BC817-40		HZG	T116			0.2	45	0.8	250 to 600	YES	
		SSTA06		HZG	T116			0.2	80	0.5	100 or more	YES	
		SST3904		HZG	T116			0.2	40	0.2	100 to 300	YES	
		SST4401		HZG	T116			0.2	40	0.6	100 to 300	YES	
		SST2222A		HZG	T116			0.2	40	0.6	100 to 300	YES	
		Darlington*3	SSTA28		—			T116	0.2	80 (V _{CEs})	0.3	10k or more	—

Notes1 : *: General Part No. have no grade code. Notes2 : *1 With reference land installed
Notes3 : *2 For h_{FE}, please see the technical specifications.
Notes4 : *3 For internal circuit, please see the technical specifications.
Notes5 : PNP (-) symbol omitted.
Notes6 : Package is JEDEC code. ():ROHM Packages, []:JEITA code

☆: Under Development

Quick Reference for High h_{FE} /Muting · Darlington Bipolar Transistors											
Package	SOT-723 (VMT3) [SC-105AA] 1212 size		SOT-416 (EMT3) [SC-75A] 1616 size		SOT-323 (UMT3) [SC-70] 2021 size		SOT-346 (SMT3) [SC-59] 2928 size		V_{CE0} (V)	I_c (A)	h_{FE}^{*2}
	Application	PNP	NPN	PNP	NPN	PNP	NPN	PNP			
High h_{FE} · Muting	$P_D=0.15W$ ^{*1}		$P_D=0.15W$ ^{*1}		$P_D=0.2W$ ^{*1}		$P_D=0.2W$ ^{*1}		25 (V_{EBO})	0.3	820 to 2700
									20	0.5	820 to 2700
		2SD2707		2SD2654		2SD2351		2SD2226K	50	0.15	820 to 2700
Darlington ^{*3}							2SD2142K		30	0.3	5k or more
							2SB852K 2SD1383K		32 (V_{CES})	0.3	5k or more

Notes1 : *1 With reference land installed
 Notes2 : *2 For h_{FE} , please see the technical specifications.
 Notes3 : *3 For internal circuit, please see the technical specifications.
 Notes4 : PNP (-) symbol omitted.
 Notes5 : Package is JEDEC code. () :ROHM Packages, [] :JEITA code

High h_{FE} /Muting · Darlington Bipolar Transistors															
Package	Application	Product No. Part No.	Grade Code		Taping Code	h_{FE}^{*2} code		Polarity (ch)	P_D^{*1} (W)	V_{CE0} (V)	I_c (A)	h_{FE}^{*2}	Automotive Grade AEC-Q101		
			General	Automotive											
 SOT-723 (VMT3) [SC-105AA] 1212 size	High h_{FE} · Muting	2SD2707	*	—	T2L	V	W	NPN	0.15	50	0.15	820 to 2700	W:Not Recommended	—	
 SOT-416 (EMT3) [SC-75A] 1616 size	High h_{FE} · Muting	2SD2654	*	—	TL	V	W	NPN	0.15	50	0.15	820 to 2700		—	
 SOT-323 (UMT3) [SC-70] 2021 size	High h_{FE} · Muting	2SD2351	*	—	T106	V	W	NPN	0.2	50	0.15	820 to 2700		—	
 SOT-346 (SMT3HP) [SC-59] 2928 size	Darlington ^{*3}	2SB852K	*	—	T146	B		PNP	0.2	32 (V_{CES})	0.3	5k or more		—	
	High h_{FE} · Muting	2SD2704K		—	T146				NPN	0.2	25 (V_{EBO})	0.3	820 to 2700		—
		2SD2114K		—	T146	V	W		NPN	0.2	20	0.5	820 to 2700		—
		2SD2226K		—	T146	V	W		NPN	0.2	50	0.15	820 to 2700		—
		2SD2142K		—	T146				NPN	0.2	30	0.3	5k or more		—
	Darlington ^{*3}	2SD1383K		—	T146	B			NPN	0.2	32 (V_{CES})	0.3	5k or more		—

Notes1 : * : General Part No. have no grade code.
 Notes2 : *1 With reference land installed
 Notes3 : *2 For h_{FE} , B: 5k or more, V: 820 to 1800, W: 1200 to 2700. Please see the technical specifications.
 Notes4 : *3 For internal circuit, please see the technical specifications.
 Notes5 : PNP (-) symbol omitted.
 Notes6 : Package is JEDEC code. () :ROHM Packages, [] :JEITA code

Bipolar Transistors

Quick Reference for High Frequency Bipolar Transistors											
Package	SOT-723 (VMT3) [SC-105AA] 1212 size		SOT-416 (EMT3) [SC-75A] 1616 size		SOT-323 (UMT3) [SC-70] 2021 size		SOT-346 (SMT3) [SC-59] 2928 size		V _{CEO} (V)	I _c (A)	h _{FE} *2
	Polarity	P _D =0.15W*1		P _D =0.15W*1		P _D =0.2W*1		P _D =0.2W*1			
Application	PNP	NPN	PNP	NPN	PNP	NPN	PNP	NPN			
High Frequency				2SC4618		2SC4098			25	0.05	82 to 180 (f _r =300MHz)
						2SC4774		2SC4713K	6	0.05	180 to 560 (f _r =800MHz)
		2SC5661		2SC4725		2SC4082		2SC3837K	20	0.05	82 to 180 (f _r =1500MHz)
		2SC5662		2SC4726		2SC4083		2SC3838K	11	0.05	56 to 180 (f _r =3200MHz)

Notes1 : *1 With reference land installed Notes2 : *2 For h_{FE}, please see the technical specifications.
Notes3 : Package is JEDEC code. () :ROHM Packages, [] :JEITA code

High Frequency Bipolar Transistors													
Package	Application	Part No.	Product No.				Polarity (ch)	P _D *1 (W)	V _{CEO} (V)	I _c (A)	h _{FE} *2	f _r (MHz)	Automotive Grade AEC-Q101
			Grade Code		Taping Code	h _{FE} *2 code							
			General	Automotive									
	High Frequency	2SC5661		—	T2L	P		0.15	20	0.05	82 to 180	1500	—
		2SC5662		—	T2L	P		0.15	11	0.05	56 to 180	3200	—
	High Frequency	2SC4618		—	TL	N	P	0.15	25	0.05	82 to 180	300	—
		2SC4725		—	TL	P		0.15	20	0.05	82 to 180	1500	—
		2SC4726		—	TL	N	P		0.15	11	0.05	56 to 180	3200
	High Frequency	2SC4098	*	—	T106	P		0.2	25	0.05	82 to 180	300	—
		2SC4774		—	T106	R	S	0.2	6	0.05	180 to 560	800	—
		2SC4082		—	T106	P		0.2	20	0.05	82 to 180	1500	—
		2SC4083		—	T106	N	P		0.2	11	0.05	56 to 180	3200
	High Frequency	2SC4713K		—	T146	R	S	0.2	6	0.05	180 to 560	800	—
		2SC3837K		—	T146	P		0.2	20	0.05	82 to 180	1500	—
		2SC3838K		—	T146	N	P		0.2	11	0.05	56 to 180	3200

Notes1 : * : General Part No. have no grade code. Notes2 : *1 With reference land installed
Notes3 : *2 For h_{FE}, N: 56 to 120, P: 82 to 180, R: 180 to 390, S: 270 to 560. Please see the technical specifications.
Notes4 : Package is JEDEC code. () :ROHM Packages, [] :JEITA code

Quick Reference for Low Saturation/Driver Bipolar Transistors											
Package	SOT-323T/SOT-363T (TUMT3/TUMT6) [SC-113A/SC-113DA] 2021 size				SOT-346T/SOT-457T (TSMT3/TSMT6) [SC-96/SC-95] 2928 size				V _{CEO} (V)	I _c (A)	h _{FE} *2
	Polarity			P _D =0.4W*1				P _D =0.5W*1			
Application	PNP	NPN	PNP	NPN	PNP	NPN	PNP	NPN			
Low V _{CE(sat)}	2SB1732	2SD2702	2SB1709	2SD2674	12	1.5	270 to 680				
	2SB1730	2SD2700	2SB1690	2SD2653	12	2	270 to 680				
	US6T4*3	US6X3*3	2SB1705	2SD2670	12	3	270 to 680				
			2SB1707	2SD2672	12	4	270 to 680				
			QST2*3	QSX1*3	12	6	270 to 680				
	2SB1733	2SD2703	2SB1710	2SD2675	30	1	270 to 680				
	2SB1731	2SD2701	2SB1695	2SD2657	30	1.5	270 to 680				
	US6T5*3	US6X4*3	2SB1706	2SD2671	30	2	270 to 680				
			2SB1708	2SD2673	30	3	270 to 680				
			QST3*3	QSX2*3	30	5	270 to 680				
Driver			2SAR512R	2SCR512R	30	2	200 to 500				
			2SAR513R	2SCR513R	50	1	180 to 450				
			2SAR553R	2SCR553R	50	2	180 to 450				
			2SAR543R	2SCR543R	50	3	180 to 450				
			2SAR514R	2SCR514R	80	0.7	120 to 390				
			2SAR554R	2SCR554R	80	1.5	120 to 390				
			2SAR544R	2SCR544R	80	2.5	120 to 390				
High Speed Switching			2SA2094	2SC5866	60	2	120 to 270				
High Voltage			2SAR340Q*3	2SCR341Q*3	400	0.1	82 to 270				

Notes1 : *1 With reference land installed Notes2 : *2 For h_{FE}, please see the technical specifications. Notes3 : *3 6pin package(TSMT6/TUMT6) For internal circuit, please see the technical specifications.
Notes4 : PNP (—) symbol omitted.
Notes5 : Package is JEDEC code. () :ROHM Packages, [] :JEITA code

Low Saturation/Driver Bipolar Transistors													
Package	Application	Product No.						Polarity (ch)	P ₀ *1 (W)	V _{CE0} (V)	I _c (A)	h _{FE} *2	Automotive Grade AEC-Q101
		Part No.	Grade Code		Taping Code	h _{FE} *2 code							
	General		Automotive										
	Low V _{CE(sat)}	2SB1732	*	—	TL			PNP	0.4	-12	-1.5	270 to 680	—
		2SB1730		—	TL				0.4	-12	-2	270 to 680	—
		2SB1733		—	TL				0.4	-30	-1	270 to 680	—
		2SB1731		—	TL				0.4	-30	-1.5	270 to 680	—
		2SD2702		—	TL			NPN	0.4	12	1.5	270 to 680	—
		2SD2700		—	TL				0.4	12	2	270 to 680	—
		2SD2703		—	TL				0.4	30	1	270 to 680	—
		2SD2701		—	TL				0.4	30	1.5	270 to 680	—
	Low V _{CE(sat)}	US6T4	*	—	TR			PNP	0.4	-12	-3	270 to 680	—
		US6T5		—	TR				0.4	-30	-2	270 to 680	—
		US6X3		—	TR			NPN	0.4	12	3	270 to 680	—
		US6X4		—	TR				0.4	30	2	270 to 680	—
	Low V _{CE(sat)}	2SB1709	*	—	TL			PNP	0.5	-12	-1.5	270 to 680	—
		2SB1690		—	TL				0.5	-12	-2	270 to 680	—
		2SB1705		—	TL				0.5	-12	-3	270 to 680	—
		2SB1707		—	TL				0.5	-12	-4	270 to 680	—
		2SB1710		—	TL				0.5	-30	-1	270 to 680	—
		2SB1695		—	TL				0.5	-30	-1.5	270 to 680	—
		2SB1706		—	TL				0.5	-30	-2	270 to 680	—
		2SB1708		—	TL				0.5	-30	-3	270 to 680	—
	Driver	2SAR512R		—	TL				0.5	-30	-2	200 to 500	—
		2SAR513R		—	TL				0.5	-50	-1	180 to 450	—
		2SAR553R		—	TL				0.5	-50	-2	180 to 450	—
		2SAR543R		—	TL				0.5	-50	-3	180 to 450	—
		2SAR514R		—	TL				0.5	-80	-0.7	120 to 390	—
		2SAR554R		—	TL				0.5	-80	-1.5	120 to 390	—
		2SAR544R		—	TL				0.5	-80	-2.5	120 to 390	—
		2SA2094		—	TL	Q			0.5	-60	-2	120 to 270	—
	Low V _{CE(sat)}	2SD2674		—	TL			NPN	0.5	12	1.5	270 to 680	—
		2SD2653		—	TL				0.5	12	2	270 to 680	—
		2SD2670		—	TL				0.5	12	3	270 to 680	—
		2SD2672		—	TL				0.5	12	4	270 to 680	—
		2SD2675		—	TL				0.5	30	1	270 to 680	—
		2SD2657		—	TL				0.5	30	1.5	270 to 680	—
		2SD2671		—	TL				0.5	30	2	270 to 680	—
		2SD2673		—	TL				0.5	30	3	270 to 680	—
	Driver	2SCR512R		—	TL			0.5	30	2	200 to 500	—	
		2SCR513R		—	TL			0.5	50	1	180 to 450	—	
		2SCR553R		—	TL			0.5	50	2	180 to 450	—	
		2SCR543R		—	TL			0.5	50	3	180 to 450	—	
2SCR514R		—	TL			0.5	80	0.7	120 to 390	—			
2SCR554R		—	TL			0.5	80	1.5	120 to 390	—			
2SCR544R		—	TL			0.5	80	2.5	120 to 390	—			
2SC5866		—	TL	Q	R	0.5	60	2	120 to 390	—			
	Low V _{CE(sat)}	QST2	*	—	TR			PNP	0.5	-12	-6	270 to 680	—
		QST3		—	TR				0.5	-30	-5	270 to 680	—
	High Voltage	2SAR340Q		—	TR	P	Q	0.5	-400	-0.1	82 to 270	—	
		QSX1		—	TR			NPN	0.5	12	6	270 to 680	—
	Low V _{CE(sat)}	QSX2		—	TR				0.5	30	5	270 to 680	—
		High Voltage		2SCR341Q	—	TR	P	Q	0.5	400	0.1	82 to 270	—

Notes1 : *: General Part No. have no grade code.
 Notes2 : *1 With reference land installed
 Notes3 : *2 For h_{FE}, P: 82 to 180, Q: 120 to 270, R: 180 to 390. Please see the technical specifications.
 Notes4 : *3 6pin package(TSMT6/TUMT6) For internal circuit, please see the technical specifications.
 Notes5 : Package is JEDEC code. () :ROHM Packages, [] :JEITA code

Bipolar Transistors

Quick Reference for Power Bipolar Transistors												
Package	DFN2020-3S (HUML2020L3) 2020 size		SOT-89 (MPT3) [SC-62] 4540 size		SOT-428 (CPT3 DPAK) [SC-63]		TO-252		V _{CEO} (V)	I _c (A)	h _{FE} *3	
	P _D =0.5W*1		P _D =0.5W*1		P _D =10W*2		P _D =10W*2					
Polarity	PNP	NPN	PNP	NPN	PNP	NPN	PNP	NPN				
Application												
Driver			2SB1697	2SD2661					12	2	270 to 680	
			2SAR293P	2SCR293P					30	1	270 to 680	
			2SAR293P5	2SCR293P5								
			2SAR512P	2SCR512P					30	2	200 to 500	
			2SAR512P5	2SCR512P5								
			2SAR552P	2SCR552P					30	3	200 to 500	
			2SAR552P5	2SCR552P5								
		2SAR542F3	New 2SCR542F3						30	3	200 to 500	
				2SAR542P	2SCR542P			New 2SAR572D3	New 2SCR572D3	30	5	200 to 500
		New 2SAR562F3	New 2SCR562F3							30	6	200 to 500
				2SAR513P	2SCR513P					50	1	180 to 450
				2SAR513P5	2SCR513P5							
				2SAR553P	2SCR553P					50	2	180 to 450
				2SAR553P5	2SCR553P5							
				2SAR533P	2SCR533P					50	3	180 to 450
				2SAR533P5	2SCR533P5							
								New 2SAR573D3	New 2SCR573D3	50	3	180 to 450
				2SB1561	2SD2391					60	2	120 to 270
				2SAR514P	2SCR514P					80	0.7	120 to 390
				2SAR514P5	2SCR514P5							
			2SAR554P	2SCR554P					80	1.5	120 to 390	
			2SAR554P5	2SCR554P5								
							New 2SAR574D3	New 2SCR574D3	80	2	120 to 390	
			2SAR544P	2SCR544P					80	2.5	120 to 390	
			2SAR544P5	2SCR544P5								
							New 2SAR586D3	New 2SCR586D3	80	5	120 to 390	
				2SCR372P					120	0.7	120 to 390	
				2SCR372P5								
				2SCR375P					120	1.5	120 to 390	
				2SCR375P5								
					2SB1275	2SD1918			160	1.5	82 to 180 120 to 270	
High Voltage			2SAR340P	2SCR346P					400	0.1	82 to 270	
High Speed Switching			2SA2071P5	2SC5824					60	3	120 to 270 120 to 390	
High h _{FE}				2SD2537					25	1.2	820 to 1800	
			2SB1427						20	2	390 to 820	
Darlington*4				2SD2153					25	2	560 to 2700	
				2SD1834					60 (V _{CES})	1	2k or more	
						2SD2143			60±10	2	1k to 10k	
					2SB1316	2SD1980			100	2	1k to 10k	

Notes1 : *1 With reference land installed
Notes2 : *2 T_c=25°C
Notes3 : *3 For h_{FE}, please see the technical specifications.
Notes4 : *4 For internal circuit, please see the technical specifications.
Notes5 : PNP (-) symbol omitted.
Notes6 : Package is JEDEC code. () :ROHM Packages, []:JEITA code

Transistors

Power Bipolar Transistors																
Package	Application	Product No.						Polarity (ch)	P _D *1 (W)	V _{CE0} (V)	I _C (A)	h _{FE} *3	Automotive Grade AEC-Q101			
		Part No.	Grade Code		Taping Code	h _{FE} *3 code										
			General	Automotive												
DFN2020-3S (HUML2020L3) 2020 size	Driver	2SAR542F3		—	TR			PNP	0.5	-30	-3	200 to 500	—			
		New 2SAR562F3	*	—	TR			NPN	0.5	-30	-6	200 to 500	—			
		New 2SCR542F3		—	TR				0.5	30	3	200 to 500	—			
		New 2SCR562F3		—	TR				0.5	30	6	200 to 500	—			
SOT-89 (MPT3) [SC-62] 4540 size	Driver	2SB1697	*	—	T100			PNP	0.5	-12	-2	270 to 680	—			
		2SAR293P		FRA	T100				0.5	-30	-1	270 to 680	YES			
		2SAR293P5	*	—	T100					0.5	-30	-1	270 to 680	—		
		2SAR512P		FRA	T100					0.5	-30	-2	200 to 500	YES		
		2SAR512P5	*	—	T100					0.5	-30	-2	200 to 500	—		
		2SAR552P		FRA	T100					0.5	-30	-3	200 to 500	YES		
		2SAR552P5	*	—	T100					0.5	-30	-3	200 to 500	—		
		2SAR542P		FRA	T100					0.5	-30	-5	200 to 500	YES		
		2SAR513P		FRA	T100					0.5	-50	-1	180 to 450	YES		
		2SAR513P5	*	—	T100					0.5	-50	-1	180 to 450	—		
		2SAR553P		FRA	T100					0.5	-50	-2	180 to 450	YES		
		2SAR553P5	*	—	T100					0.5	-50	-2	180 to 450	—		
		2SAR533P		FRA	T100					0.5	-50	-3	180 to 450	YES		
		2SAR533P5	*	—	T100					0.5	-50	-3	180 to 450	—		
		2SB1561		—	T100		Q				0.5	-60	-2	120 to 270	—	
		2SAR514P		FRA	T100						0.5	-80	-0.7	120 to 390	YES	
		2SAR514P5	*	—	T100						0.5	-80	-0.7	120 to 390	—	
		2SAR554P		FRA	T100						0.5	-80	-1.5	120 to 390	YES	
		2SAR554P5	*	—	T100						0.5	-80	-1.5	120 to 390	—	
		2SAR544P		FRA	T100						0.5	-80	-2.5	120 to 390	YES	
		2SAR544P5	*	—	T100						0.5	-80	-2.5	120 to 390	—	
		2SAR340P		—	T100		P		Q		0.5	-400	-0.1	82 to 270	—	
		High Voltage														
		High Speed Switching		2SA2071P5	*	—	T100		Q			0.5	-60	-3	120 to 270	—
		High h _{FE}		2SB1427		—	T100		E			0.5	-20	-2	390 to 820	—
	SOT-89 (MPT3) [SC-62] 4540 size	Driver	2SD2661		—	T100			NPN	0.5	12	2	270 to 680	—		
			2SCR293P		FRA	T100				0.5	30	1	270 to 680	YES		
			2SCR293P5	*	—	T100					0.5	30	1	270 to 680	—	
			2SCR512P		FRA	T100					0.5	30	2	200 to 500	YES	
			2SCR512P5	*	—	T100					0.5	30	2	200 to 500	—	
			2SCR552P		FRA	T100					0.5	30	3	200 to 500	YES	
			2SCR552P5	*	—	T100					0.5	30	3	200 to 500	—	
			2SCR542P		FRA	T100					0.5	30	5	200 to 500	YES	
			2SCR513P		FRA	T100					0.5	50	1	180 to 450	YES	
			2SCR513P5	*	—	T100					0.5	50	1	180 to 450	—	
			2SCR553P		FRA	T100					0.5	50	2	180 to 450	YES	
			2SCR553P5	*	—	T100					0.5	50	2	180 to 450	—	
			2SCR533P		FRA	T100					0.5	50	3	180 to 450	YES	
			2SCR533P5	*	—	T100					0.5	50	3	180 to 450	—	
			2SD2391		FRA	T100		Q				0.5	60	2	120 to 270	—
			2SCR514P		FRA	T100						0.5	80	0.7	120 to 390	YES
			2SCR514P5	*	—	T100						0.5	80	0.7	120 to 390	—
			2SCR554P		FRA	T100						0.5	80	1.5	120 to 390	YES
			2SCR554P5	*	—	T100						0.5	80	1.5	120 to 390	—
			2SCR544P		FRA	T100						0.5	80	2.5	120 to 390	YES
2SCR544P5			*	—	T100						0.5	80	2.5	120 to 390	—	
2SCR372P				FRA	T100		Q	R			0.5	120	0.7	120 to 390	YES	
2SCR372P5			*	—	T100		Q	R			0.5	120	0.7	120 to 390	—	
2SCR375P				FRA	T100		Q	R			0.5	120	1.5	120 to 390	YES	
2SCR375P5			*	—	T100		Q	R			0.5	120	1.5	120 to 390	—	
High Voltage			2SCR346P		—	T100	P	Q		0.5	400	0.1	82 to 270	—		
High Speed Switching			2SC5824	*	—	T100	Q	R		0.5	60	3	120 to 390	—		
High h _{FE}			2SD2537		—	T100	V			0.5	25	1.2	820 to 1800	—		
			2SD2153		—	T100	U	V	W	0.5	25	2	560 to 2700	—		
Darlington*4			2SD1834		—	T100				0.5	60 (V _{CE} S)	1	2k or more	—		
SOT-428 (CPT3) [SC-63]		Driver	2SB1275		—	TL	P		PNP	10*2	-160	-1.5	82 to 180	—		
		Darlington*4	2SB1316	*	—	TL				10*2	-100	-2	1k to 10k	—		
		Driver	2SD1918		—	TL	Q			NPN	10*2	160	1.5	120 to 270	—	
		Darlington*4	2SD2143		—	TL					10*2	60±10	2	1k to 10k	—	
		Darlington*4	2SD1980		—	TL					10*2	100	2	1k to 10k	—	
TO-252	Driver	New 2SAR572D3		—	TL1			PNP	10*2	-30	-5	200 to 500	—			
		New 2SAR573D3	*	—	TL1				10*2	-50	-3	180 to 450	—			
		New 2SAR574D3		—	TL1				10*2	-80	-2	120 to 390	—			
		New 2SAR586D3		—	TL1				10*2	-80	-5	120 to 390	—			
		New 2SCR572D3		—	TL1			NPN	10*2	30	5	200 to 500	—			
		New 2SCR573D3	*	—	TL1				10*2	50	3	180 to 450	—			
		New 2SCR574D3		—	TL1				10*2	80	2	120 to 390	—			
		New 2SCR586D3		—	TL1				10*2	80	5	120 to 390	—			

Notes1 : *: General Part No. have no grade code.
 Notes2 : *1 With reference land installed
 Notes3 : *2 Tc=25°C
 Notes4 : *3 h_{FE} P:82 to 180, Q:120 to 270, R:180 to 390, U:560 to 1200, V:820 to 1800, W:1200 to 2700. Please see the technical specifications.
 Notes5 : *4 For internal circuit, please see the technical specifications.
 Notes6 : Package is JEDEC code. () :ROHM Packages, [] :JEITA code

Complex Bipolar Transistors

Quick Reference for General Purpose Amplification Complex Bipolar Transistors										
Configuration	Package	Item	(VMT6)	SOT-553/SOT-563	SOT-353/SOT-363	SOT-25/SOT-457	Equivalent Element Transistors	V _{CEO} (V)	I _c (A)	h _{FE}
			[SC-105B] 1212 size	(EMT5/EMT6) [SC-107BB/SC-107C] 1616 size	(UMT5/UMT6) [SC-88A/SC-88] 2021 size	(SMT5/SMT6) [SC-74A/SC-74] 2928 size				
Application	Equivalent Circuit Diagram (TOP View)		Part No.							
PNP×2	Pre Amp.		VT6T1	EMT51			2SAR522EB×2	-20	-0.2	120 to 560
			VT6T2	EMT52			2SAR523EB×2	-50	-0.1	120 to 560
				EMT1	UMT1N	IMT1A	2SA1037AK×2	-50	-0.15	120 to 560
				EMT18	UMT18N	IMT18	2SA2018×2	-12	-0.5	270 to 680
NPN×2	Pre Amp.		VT6X1	EMX51			2SCR522EB×2	20	0.2	120 to 560
			VT6X2	EMX52			2SCR523EB×2	50	0.1	120 to 560
				EMX1	UMX1N	IMX1	2SC2412K×2	50	0.15	120 to 560
				EMX26			2SD2654×2	50	0.15	820 to 2700
				EMX18	UMX18N		2SC5585×2	12	0.5	270 to 680
						IMX25	2SD2704K×2	20	0.3	820 to 2700
PNP + NPN	Pre Amp.			EMY1	UMY1N	FMY1A	2SA1037AK 2SC2412K	-50 50	-0.15 0.15	120 to 560 120 to 560
			VT6Z1	EMZ51			2SAR522EB 2SCR522EB	-20 20	-0.2 0.2	120 to 560 120 to 560
			VT6Z2	EMZ52			2SAR523EB 2SCR523EB	-50 50	-0.1 0.1	120 to 560 120 to 560
				EMZ1	UMZ1N	IMZ1A	2SA1037AK 2SC2412K	-50 50	-0.15 0.15	120 to 560 120 to 560
				EMZ7			2SA2018 2SC5585	-12 12	-0.5 0.5	270 to 680 270 to 680
				EMZ8			2SA2018 2SC2412K	-12 50	-0.5 0.15	270 to 680 120 to 560

Notes1 : For Pin location, please see the technical specifications.
Notes2 : Package is JEDEC code. () :ROHM Packages, [] :JEITA code

General Purpose Amplification Complex Bipolar Transistors											
Package	Configuration	Application	Product No.			Equivalent Element Transistors	V _{CEO} (V)	I _C (A)	h _{FE}	Automotive Grade AEC-Q101	
			Part No.	Grade Code							Taping Code
				General	Automotive						
 (VMT6) [SC-105B] 1212 size	PNP×2	Pre Amp.	VT6T1	*	—	T2R	2SAR522EB×2	−20	−0.2	120 to 560	—
			VT6T2		—	T2R	2SAR523EB×2	−50	−0.1	120 to 560	—
	NPN×2		VT6X1		—	T2R	2SCR522EB×2	20	0.2	120 to 560	—
			VT6X2		—	T2R	2SCR523EB×2	50	0.1	120 to 560	—
	PNP+NPN		VT6Z1		—	T2R	2SAR522EB	20	0.2	120 to 560	—
			VT6Z2		—	T2R	2SAR523EB	50	0.1	120 to 560	—
 SOT-553 (EMT5) [SC-107BB] 1616 size	PNP+NPN	Pre Amp.	EMY1	*	—	T2R	2SA1037AK 2SC2412K	−50 50	−0.15 0.15	120 to 560 120 to 560	—
 SOT-563 (EMT6) [SC-107C] 1616 size	PNP×2	Pre Amp.	EMT51	*	—	T2R	2SAR522EB×2	−20	−0.2	120 to 560	—
			EMT52		—	T2R	2SAR523EB×2	−50	−0.1	120 to 560	—
			EMT1		FHA	T2R	2SA1037AK×2	−50	−0.15	120 to 560	YES
			EMT18		—	T2R	2SA2018×2	−12	−0.5	270 to 680	—
	NPN×2		EMX51		—	T2R	2SCR522EB×2	20	0.2	120 to 560	—
			EMX52		—	T2R	2SCR523EB×2	50	0.1	120 to 560	—
			EMX1		FHA	T2R	2SC2412K×2	50	0.15	120 to 560	YES
			EMX26		—	T2R	2SD2654×2	50	0.15	820 to 2700	—
	PNP+NPN		EMX18		—	T2R	2SC5585×2	12	0.5	270 to 680	—
			EMZ51		—	T2R	2SAR522EB	20	0.2	120 to 560	—
			EMZ52		—	T2R	2SAR523EB	50	0.1	120 to 560	—
					—	T2R	2SCR523EB	50	0.1	120 to 560	—
			EMZ1		FHA	T2R	2SA1037AK 2SC2412K	−50 50	−0.15 0.15	120 to 560 120 to 560	YES
			EMZ7		—	T2R	2SA2018	−12	−0.5	270 to 680	—
					—	T2R	2SC5585	12	0.5	270 to 680	—
			EMZ8		—	T2R	2SA2018 2SC2412K	−12 50	−0.5 0.15	270 to 680 270 to 680	—
 SOT-353 (UMT5) [SC-88A] 2021 size	PNP+NPN	Pre Amp.	UMY1N	*	—	TR	2SA1037AK 2SC2412K	−50 50	−0.15 0.15	120 to 560 120 to 560	—
 SOT-363 (UMT6) [SC-88] 2021 size	PNP×2	Pre Amp.	UMT1N	*	FHA	TN	2SA1037AK×2	−50	−0.5	120 to 560	YES
			UMT18N		—	TR	2SA2018×2	−12	−0.5	270 to 680	—
	NPN×2		UMX1N		FHA	TN	2SC2412K×2	50	0.15	120 to 560	YES
			UMX18N		—	TN	2SC5585×2	12	0.5	270 to 680	—
PNP+NPN	UMZ1N	FHA	TR	2SA1037AK 2SC2412K	−50 50	−0.15 0.15	120 to 560 120 to 560	YES			
 SOT-25 (SMT5) [SC-74A] 2928 size	PNP+NPN	Pre Amp.	FMY1A	*	—	T148	2SA1037AK 2SC2412K	−50 50	−0.15 0.15	120 to 560 120 to 560	—
 SOT-457 (SMT6) [SC-74] 2928 size	PNP×2	Pre Amp.	IMT1A	*	—	T110	2SA1037AK×2	−50	−0.5	120 to 560	YES*1
			IMT18		—	T110	2SA2018×2	−12	−0.5	270 to 680	—
	NPN×2		IMX1		—	T110	2SC2412K×2	50	0.15	120 to 560	YES*1
			IMX25		—	T110	2SD2704K×2	20	0.3	820 to 2700	—
	PNP+NPN		IMZ1A		—	T108	2SA1037AK 2SC2412K	−50 50	−0.15 0.15	120 to 560 120 to 560	YES*1

Notes1 : *: General Part No. have no grade code.
 Notes2 : *1 Not recommended for a new design.
 Notes3 : For Pin location, please see the technical specifications.
 Notes4 : Package is JEDEC code. () : ROHM Packages, [] : JEITA code

Complex Bipolar Transistors

Quick Reference for Complex Bipolar Transistors(For Current Mirror Circuit)								
Configuration	Package	Item	(VMT6) [SC-105B] 1212 size	Equivalent Element Transistors	V _{CEO} (V)	I _C (A)	h _{FE}	h _{FE} Ratio
			◆					
Application	Equivalent Circuit Diagram (TOP View)	Part No.						
PNP×2	Suitable for Current Mirror Circuit		VT6T11	2SAR522M×2	-20	-0.2	120 to 560	±10%
			VT6T12	2SAR523M×2	-50	-0.1	120 to 560	
NPN×2	Suitable for Current Mirror Circuit		VT6X11	2SCR522M×2	20	0.2	120 to 560	
			VT6X12	2SCR523M×2	50	0.1	120 to 560	

Notes1 : For Pin location, please see the technical specifications.
Notes2 : Package is JEDEC code. () :ROHM Packages , [] :JEITA code

Complex Bipolar Transistors(For Current Mirror Circuit)												
Package	Configuration	Application	Product No.			Equivalent Element Transistors	V _{CEO} (V)	I _C (A)	h _{FE}	h _{FE} Ratio	Automotive Grade AEC-Q101	
			Part No.	Grade Code								Taping Code
				General	Automotive							
◆ (VMT6) [SC-105B] 1212 size	PNP×2	Suitable for Current Mirror Circuit	VT6T11	*	—	T2R	2SAR522M×2	-20	-0.2	120 to 560	±10%	—
			VT6T12		—	T2R	2SAR523M×2	-50	-0.1	120 to 560	±10%	—
	NPN×2		VT6X11		—	T2R	2SCR522M×2	20	0.2	120 to 560	±10%	—
			VT6X12		—	T2R	2SCR523M×2	50	0.1	120 to 560	±10%	—

Notes1 : *: General Part No. have no grade code.
Notes2 : For Pin location, please see the technical specifications.
Notes3 : () :ROHM Packages, [] :JEITA code

Quick Reference for Complex Bipolar Transistors(For Power Supply Circuit)								
Configuration	Package	Item	SOT-563 (EMT6) [SC-107C] 1616 size	SOT-353/SOT-363 (UMT5/UMT6) [SC-88A/SC-88] 2021 size	Equivalent Element Transistors	V _{CEO} (V)	I _C (mA)	h _{FE}
Application	Equivalent Circuit Diagram (TOP View)		Part No.					
PNP+DTR	Power Management		EMF5	UMF5N	2SA2018 DTC144E	-12 50	-500 100	270 to 680 68 or more
				UMF28N	2SA1774 DTC124X	-50 50	-150 100	180 to 390 68 or more
PNP+Di	DC-DC Converter			UML1N	2SA1774 DAN202K	-50 80	-150 100	120 to 560 —
				UML4N	2SA2018 RB521S-30	-12 30	-500 200	270 to 680 —
NPN+Di				UML2N	2SC4617 DAN202K	50 80	150 100	120 to 560 —
				UML6N	2SC5585 RB521S-30	12 30	500 200	270 to 680 —
NPN+Di	Shunt Regulator		EML22	UML23N	2SC2412K VDZ6.8B	50 V _Z =6.8	150 I _Z =5	120 to 390 —

Notes1 : For Pin location, please see the technical specifications.
Notes2 : Package is JEDEC code. () :ROHM Packages , [] :JEITA code

Complex Bipolar Transistors(For Power Supply Circuit)											
Package	Configuration	Application	Product No.			Equivalent Element Transistors	V _{CEO} (V)	I _C (mA)	h _{FE}	Automotive Grade AEC-Q101	
			Part No.	Grade Code	Taping Code						
				General	Automotive						
 SOT-563 (EMT6) [SC-107C] 1616 size	PNP+DTR	Power Management	EMF5	*	—	T2R	2SA2018 DTC144E	-12 50	-500 100	270 to 680 68 or more	—
	NPN+Di	Shunt Regulator	EML22	*	—	T2R	2SC2412K VDZ6.8B	50 V _Z =6.8	150 I _Z =5	120 to 390 —	—
 SOT-353 (UMT5) [SC-88A] 2021 size	PNP+Di	DC-DC Converter	UML1N	*	—	TR	2SA1774 DAN202K	-50 80	-150 100	120 to 560 —	—
			UML4N	*	—	TR	2SA2018 RB521S-30	-12 30	-500 200	270 to 680 —	—
	NPN+Di		UML2N	*	—	TR	2SC4617 DAN202K	50 80	150 100	120 to 560 —	—
			UML6N	*	—	TR	2SC5585 RB521S-30	12 30	500 200	270 to 680 —	—
 SOT-363 (UMT6) [SC-88] 2021 size	PNP+DTR	Power Management	UMF5N	*	—	TR	2SA2018 DTC144E	-12 50	-500 100	270 to 680 68 or more	—
			UMF28N	*	—	TR	2SA1774 DTC124X	-50 50	-150 100	180 to 390 68 or more	—
	NPN+Di	Shunt Regulator	UML23N	*	—	TR	2SC2412K VDZ6.8B	50 V _Z =6.8	150 I _Z =5	120 to 390 —	—

Notes1 : *: General Part No. have no grade code.
Notes2 : For Pin location, please see the technical specifications.
Notes3 : Package is JEDEC code. () :ROHM Packages , [] :JEITA code

Complex Bipolar Transistors

Quick Reference for Complex Bipolar Transistors(For Drivers)								
Configuration	Package	Equivalent Circuit Diagram (TOP View)	SOT-363T (TUMT6) [SC-113DA] 2021 size	SOT-25T/SOT-457T (TSMT5/TSMT6) [—/SC-95] 2928 size	Equivalent Element Transistors	V _{CEO} (V)	I _C (A)	h _{FE}
	Item		Part No.					
	Application							
PNP×2	Driver		US6T8	QST8	2SB1709×2	-12	-1.5	270 to 680
			US6T9	QST9	2SB1710×2	-30	-1	270 to 680
NPN×2	Driver		US6X7	QSX7	2SD2674×2	12	1.5	270 to 680
			US6X8	QSX8	2SD2675×2	30	1	270 to 680
	DC-DC Converter			QS5W1	Exclusive Chip	30	3	200 to 500
				QS5W2	2SCR533P×2	50	3	180 to 450
PNP + NPN	Pre Amp.			QS6Z5	2SAR513P 2SCR513P	-50 50	-1 1	180 to 450 180 to 450
				QS5Y1	Exclusive Chip	-30 30	-3 3	200 to 500 200 to 500
	DC-DC Converter			QSZ4	2SB1706 2SD2671	-30 30	-2 2	270 to 680 270 to 680
				QSZ2	2SB1695 2SD2657	-30 30	-1.5 1.5	270 to 680 270 to 680
				QS5Y2	2SAR533P 2SCR533P	-50 50	-3 3	180 to 450 180 to 450
				QS5Y2	2SAR533P 2SCR533P	-50 50	-3 3	180 to 450 180 to 450

Notes1 : For Pin location, please see the technical specifications.
Notes2 : Package is JEDEC code. () :ROHM Packages, [] :JEITA code

Complex Bipolar Transistors(For Drivers)											
Package	Configuration	Application	Product No.				Equivalent Element Transistors	V _{CEO} (V)	I _C (A)	h _{FE}	Automotive Grade AEC-Q101
			Part No.	Grade Code		Taping Code					
				General	Automotive						
SOT-363T (TUMT6) [SC-113DA] 2021 size	PNP×2	Driver	US6T8	*	—	TR	2SB1709×2	-12	-1.5	270 to 680	—
			US6T9	—	TR	2SB1710×2	-30	-1	270 to 680	—	
	NPN×2		US6X7	—	TR	2SD2674×2	12	1.5	270 to 680	—	
			US6X8	—	TR	2SD2675×2	30	1	270 to 680	—	
SOT-25T (TSMT5) 2928 size	NPN×2	DC-DC Converter	QS5W1	*	—	TR	Exclusive Chip	30	3	200 to 500	—
			QS5W2	—	TR	2SCR533P×2	50	3	180 to 450	—	
	PNP+NPN		QS5Y1	—	TR	Exclusive Chip	-30 30	-3 3	200 to 500 200 to 500	—	
			QSZ4	—	TR	2SB1706 2SD2671	-30 30	-2 2	270 to 680 270 to 680	—	
			QSZ2	—	TR	2SB1695 2SD2657	-30 30	-1.5 1.5	270 to 680 270 to 680	—	
			QS5Y2	—	TR	2SAR533P 2SCR533P	-50 50	-3 3	180 to 450 180 to 450	—	
SOT-457T (TSMT6) [SC-95] 2928 size	PNP+NPN	Pre Amp.	QS6Z5	*	—	TR	2SAR513P 2SCR513P	-50 50	-1 1	180 to 450 180 to 450	—
	PNP×2	Driver	QST8	—	TR	2SB1709×2	-12	-1.5	270 to 680	—	
			QST9	—	TR	2SB1710×2	-30	-1	270 to 680	—	
			QSX7	—	TR	2SD2674×2	12	1.5	270 to 680	—	
			QSX8	—	TR	2SD2675×2	30	1	270 to 680	—	

Notes1 : *: General Part No. have no grade code.
Notes2 : For Pin location, please see the technical specifications.
Notes3 : Package is JEDEC code. () :ROHM Packages, [] :JEITA code

Digital Transistors

Quick Reference for 100mA Digital Transistors(For Automotive use)																							
Item	Part No.		R1 (kΩ)	R2 (kΩ)	Package														V _{CE0} (V)	I ₀ (A)	G _I (h _{FE})		
	PNP	NPN			SOT-723 (VMT3) [SC-105AA] 1212 size		SOT-416FL (EMT3F) [SC-89] 1616 size		SOT-416 (EMT3) [SC-75A] 1616 size		SOT-323FL (UMT3F) [SC-85] 2021 size		SOT-323 (UMT3) [SC-70] 2021 size		SOT-23 (SST3) 2924 size		SOT-346 (SMT3) [SC-59] 2928 size						
					P ₀ =150mW*1							P ₀ =200mW*1											
	PNP	NPN			PNP	NPN	PNP	NPN	PNP	NPN	PNP	NPN	PNP	NPN	PNP	NPN	PNP	NPN					
	Quick Reference No.																						
R1=R2 Potential Divider type	DTA123Ex	DTC123Ex	2.2	2.2	1	20	39	54	69	84	99	114	129	153	☆178	☆193	210	231	252	267	0.1	20 or more	
	DTA143Ex	DTC143Ex	4.7	4.7	2	21	40	55	70	85	100	115	130	154	☆179	☆194	211	232	253	268	0.1	30 or more	
	DTA114Ex	DTC114Ex	10	10	3	22	41	56	71	86	101	116	131	155	☆180	☆195	212	233	254	269	0.05	30 or more	
	DTA124Ex	DTC124Ex	22	22	4	23	42	57	72	87	102	117	132	156	☆181	☆196	213	234	255	270	0.03	56 or more	
	DTA144Ex	DTC144Ex	47	47	5	24	43	58	73	88	103	118	133	157	☆182	☆197	214	235	256	271	0.03	68 or more	
	DTA115Ex	DTC115Ex	100	100	6	25	44	59	74	89	104	119	134	158	☆183	☆198	215	236	257	272	0.02	82 or more	
R1≠R2 Leak Absorption type	DTA113Zx	DTC113Zx	1	10	7	26	45	60	New 75	90	105	120	135	159	☆184	☆199	216	237	258	273	0.1	33 or more	
	DTA123Yx	DTC123Yx	2.2	10	8	27	New 46	New 61	76	91	106	121	136	160	☆185	☆200	217	238	259	274	0.1	33 or more	
	DTA123Jx	DTC123Jx	2.2	47	9	28	47	62	77	92	107	122	137	161	☆186	☆201	218	239	260	275	0.1	80 or more	
	DTA143Xx	DTC143Xx	4.7	10	10	29	48	63	78	93	108	123	138	162	☆187	☆201	219	240	261	276	0.1	30 or more	
	DTA143Zx	DTC143Zx	4.7	47	11	30	49	64	79	94	109	124	139	163	☆188	☆203	220	241	262	277	0.1	80 or more	
	DTA114Wx	DTC114Wx	10	4.7	New 12	New 31							New 140	New 164								0.1	24 or more
	DTA114Yx	DTC114Yx	10	47	13	32	50	65	80	95	110	125	141	165	☆189	☆204	221	242	263	278	0.07	68 or more	
	DTA124Xx	DTC124Xx	22	47	14	33	51	66	81	96	111	126	142	166	☆190	☆205	222	243	264	279	0.05	68 or more	
	DTA144Vx	DTC144Vx	47	10	New 15	New 34											New 223	New 244				0.03	33 or more
Type Using R1 Alone as Input Resistor	DTA144Wx	DTC144Wx	47	22	New 16	New 35							143	167		New 224	New 245				0.03	56 or more	
	DTA123Tx	DTC123Tx	2.2	—	New 17	New 36							New 144	New 168		New 225	New 246				0.1	100 to 600	
	DTA143Tx	DTC143Tx	4.7	—	18	37	52	67	82	97	112	127	145	169	☆191	☆206	226	247	265	280	0.1	100 to 600	
	DTA114Tx	DTC114Tx	10	—	19	38	53	68	83	98	113	128	146	170	☆192	☆207	227	248	266	281	0.1	100 to 600	
	DTA124Tx	DTC124Tx	22	—									147	171		New 228	New 249				0.1	100 to 600	
	DTA144Tx	DTC144Tx	47	—									148	172		New 229	New 250				0.1	100 to 600	
Type Using R2 Alone as Input Resistor	DTA115Tx	DTC115Tx	100	—									149	173		New 230	New 251				0.1	100 to 600	
	DTA114Gx	DTC114Gx	—	10									150	174	☆208						0.1	30 or more	
	DTA124Gx	DTC124Gx	—	22										175							0.1	56 or more	
	DTA144Gx	DTC144Gx	—	47									151	176							0.1	68 or more	
DTA115Gx	DTC115Gx	—	100									152	177	☆209						0.1	82 or more		
x : Packaging designation symbol					M	EB	E	UB	UA	U3	CA	KA											

Notes1 : VMT3, EMT3F, EMT3 and UMT3F without suffix A.
 Notes2 : *1 With reference land installed.
 Notes3 : PNP (-) symbol omitted.
 Notes4 : Package is JEDEC code. () : ROHM Packages, [] : JEITA code

☆ : Under Development

Digital Transistors

100mA Digital Transistors(For Automotive use)													
Package	Quick Reference No.	Product No.				Polarity (ch)	P ₀ *1 (mW)	R1 (kΩ)	R2 (kΩ)	V _{CC} (V _{CEO}) (V)	I _o (I _c) (A)	G _I (h _{FE})	Automotive Grade AEC-Q101
		Part No.	Grade Code		Taping Code								
			General	Automotive									
SOT-723 (VMT3) [SC-105AA] 1212 size	1	DTA123EM	*	FHA	T2L	PNP	150	2.2	2.2	50	0.1	20 or more	YES
	2	DTA143EM		FHA	T2L		150	4.7	4.7	50	0.1	30 or more	YES
	3	DTA114EM		FHA	T2L		150	10	10	50	0.05	30 or more	YES
	4	DTA124EM		FHA	T2L		150	22	22	50	0.03	56 or more	YES
	5	DTA144EM		FHA	T2L		150	47	47	50	0.03	68 or more	YES
	6	DTA115EM		FHA	T2L		150	100	100	50	0.02	82 or more	YES
	7	DTA113ZM		FHA	T2L		150	1	10	50	0.1	33 or more	YES
	8	DTA123YM		FHA	T2L		150	2.2	10	50	0.1	33 or more	YES
	9	DTA123JM		FHA	T2L		150	2.2	47	50	0.1	80 or more	YES
	10	DTA143XM		FHA	T2L		150	4.7	10	50	0.1	30 or more	YES
	11	DTA143ZM		FHA	T2L		150	4.7	47	50	0.1	80 or more	YES
	12	New DTA114WWM		FHA	T2L		150	10	4.7	50	0.1	24 or more	YES
	13	DTA114YM		FHA	T2L		150	10	47	50	0.07	68 or more	YES
	14	DTA124XM		FHA	T2L		150	22	47	50	0.05	68 or more	YES
	15	New DTA144VWM		FHA	T2L		150	47	10	50	0.03	33 or more	YES
	16	New DTA144WWM		FHA	T2L		150	47	22	50	0.03	56 or more	YES
	17	New DTA123TM		FHA	T2L		150	2.2	—	50	0.1	100 to 600	YES
	18	DTA143TM		FHA	T2L		150	4.7	—	50	0.1	100 to 600	YES
	19	DTA114TM		FHA	T2L		150	10	—	50	0.1	100 to 600	YES
	20	DTC123EM		FHA	T2L		150	2.2	2.2	50	0.1	20 or more	YES
	21	DTC143EM		FHA	T2L		150	4.7	4.7	50	0.1	30 or more	YES
	22	DTC114EM		FHA	T2L		150	10	10	50	0.05	30 or more	YES
	23	DTC124EM		FHA	T2L		150	22	22	50	0.03	56 or more	YES
	24	DTC144EM		FHA	T2L		150	47	47	50	0.03	68 or more	YES
	25	DTC115EM		FHA	T2L		150	100	100	50	0.02	82 or more	YES
	26	DTC113ZM		FHA	T2L		150	1	10	50	0.1	33 or more	YES
	27	DTC123YM		FHA	T2L		150	2.2	10	50	0.1	33 or more	YES
	28	DTC123JM		FHA	T2L		150	2.2	47	50	0.1	80 or more	YES
	29	DTC143XM		FHA	T2L		150	4.7	10	50	0.1	30 or more	YES
	30	DTC143ZM		FHA	T2L		150	4.7	47	50	0.1	80 or more	YES
	31	New DTC114WWM		FHA	T2L		200	10	4.7	50	0.1	24 or more	YES
	32	DTC114YM		FHA	T2L		150	10	47	50	0.07	68 or more	YES
	33	DTC124XM		FHA	T2L		150	22	47	50	0.05	68 or more	YES
	34	New DTC144VWM		FHA	T2L		150	47	10	50	0.03	33 or more	YES
	35	New DTC144WWM		FHA	T2L		150	47	22	50	0.03	56 or more	YES
	36	New DTC123TM		FHA	T2L		150	2.2	—	50	0.1	100 to 600	YES
	37	DTC143TM		FHA	T2L		150	4.7	—	50	0.1	100 to 600	YES
	38	DTC114TM		FHA	T2L		150	10	—	50	0.1	100 to 600	YES
SOT-416FL (EMT3F) [SC-89] 1616 size	39	DTA123EEB	*	HZG	TL	PNP	150	2.2	2.2	50	0.1	20 or more	YES
	40	DTA143EEB		HZG	TL		150	4.7	4.7	50	0.1	30 or more	YES
	41	DTA114EEB		HZG	TL		150	10	10	50	0.05	30 or more	YES
	42	DTA124EEB		HZG	TL		150	22	22	50	0.03	56 or more	YES
	43	DTA144EEB		HZG	TL		150	47	47	50	0.03	68 or more	YES
	44	DTA115EEB		HZG	TL		150	100	100	50	0.02	82 or more	YES
	45	DTA113ZEB		HZG	TL		150	1	10	50	0.1	33 or more	YES
	46	New DTA123YEB		HZG	TL		150	2.2	10	50	0.1	33 or more	YES
	47	DTA123JEB		HZG	TL		150	2.2	47	50	0.1	80 or more	YES
	48	DTA143XEB		HZG	TL		150	4.7	10	50	0.1	30 or more	YES
	49	DTA143ZEB		HZG	TL		150	4.7	47	50	0.1	80 or more	YES
	50	DTA114YEB		HZG	TL		150	10	47	50	0.07	68 or more	YES
	51	DTA124XEB		HZG	TL		150	22	47	50	0.05	68 or more	YES
	52	DTA143TEB		HZG	TL		150	4.7	—	50	0.1	100 to 600	YES
	53	DTA114TEB		HZG	TL		150	10	—	50	0.1	100 to 600	YES
	54	DTC123EEB		HZG	TL		150	2.2	2.2	50	0.1	20 or more	YES
	55	DTC143EEB		HZG	TL		150	4.7	4.7	50	0.1	30 or more	YES
	56	DTC114EEB		HZG	TL		150	10	10	50	0.05	30 or more	YES
	57	DTC124EEB		HZG	TL		150	22	22	50	0.03	56 or more	YES
	58	DTC144EEB		HZG	TL		150	47	47	50	0.03	68 or more	YES
	59	DTC115EEB		HZG	TL		150	100	100	50	0.02	82 or more	YES
	60	DTC113ZEB		HZG	TL		150	1	10	50	0.1	33 or more	YES
	61	New DTC123YEB		HZG	TL		150	2.2	10	50	0.1	33 or more	YES
	62	DTC123JEB		HZG	TL		150	2.2	47	50	0.1	80 or more	YES
	63	DTC143XEB		HZG	TL		150	4.7	10	50	0.1	30 or more	YES
	64	DTC143ZEB		HZG	TL		150	4.7	47	50	0.1	80 or more	YES
	65	DTC114YEB		HZG	TL		150	10	47	50	0.07	68 or more	YES
	66	DTC124XEB		HZG	TL		150	22	47	50	0.05	68 or more	YES
	67	DTC143TEB		HZG	TL		150	4.7	—	50	0.1	100 to 600	YES
	68	DTC114TEB		HZG	TL		150	10	—	50	0.1	100 to 600	YES

Notes1 : * : General part No. have no grade code.
 Notes2 : *1 With reference land installed.
 Notes3 : PNP (—) symbol omitted.
 Notes4 : Package is JEDEC code. () :ROHM Packages , [] :JEITA code

100mA Digital Transistors(For Automotive use)													
Package	Product No.					Polarity (ch)	P _D *1 (mW)	R1 (kΩ)	R2 (kΩ)	V _{CC} (V _{CE0}) (V)	I _O (I _C) (A)	G _I (h _{FE})	Automotive Grade AEC-Q101
	Quick Reference No.	Part No.	Grade Code		Taping Code								
			General	Automotive									
	69	DTA123EE	*	FRA	TL	PNP	150	2.2	2.2	50	0.1	20 or more	YES
	70	DTA143EE		FRA	TL		150	4.7	4.7	50	0.1	30 or more	YES
	71	DTA114EE		FRA	TL		150	10	10	50	0.05	30 or more	YES
	72	DTA124EE		FRA	TL		150	22	22	50	0.03	56 or more	YES
	73	DTA144EE		FRA	TL		150	47	47	50	0.03	68 or more	YES
	74	DTA115EE		FRA	TL		150	100	100	50	0.02	82 or more	YES
	75	New DTA113ZE		FRA	TL		150	1	10	50	0.1	33 or more	YES
	76	DTA123YE		FRA	TL		150	2.2	10	50	0.1	33 or more	YES
	77	DTA123JE		FRA	TL		150	2.2	47	50	0.1	80 or more	YES
	78	DTA143XE		FRA	TL		150	4.7	10	50	0.1	30 or more	YES
	79	DTA143ZE		FRA	TL		150	4.7	47	50	0.1	80 or more	YES
	80	DTA114YE		FRA	TL		150	10	47	50	0.07	68 or more	YES
	81	DTA124XE		FRA	TL		150	22	47	50	0.05	68 or more	YES
	82	DTA143TE		FRA	TL		150	4.7	—	50	0.1	100 to 600	YES
	83	DTA114TE		FRA	TL		150	10	—	50	0.1	100 to 600	YES
	84	DTC123EE		FRA	TL		150	2.2	2.2	50	0.1	20 or more	YES
	85	DTC143EE		FRA	TL		150	4.7	4.7	50	0.1	30 or more	YES
	86	DTC114EE		FRA	TL		150	10	10	50	0.05	30 or more	YES
	87	DTC124EE		FRA	TL		150	22	22	50	0.03	56 or more	YES
	88	DTC144EE		FRA	TL		150	47	47	50	0.03	68 or more	YES
	89	DTC115EE		FRA	TL		150	100	100	50	0.02	82 or more	YES
	90	DTC113ZE		FRA	TL		150	1	10	50	0.1	33 or more	YES
	91	DTC123YE		FRA	TL		150	2.2	10	50	0.1	33 or more	YES
	92	DTC123JE		FRA	TL		150	2.2	47	50	0.1	80 or more	YES
	93	DTC143XE		FRA	TL		150	4.7	10	50	0.1	30 or more	YES
	94	DTC143ZE		FRA	TL		150	4.7	47	50	0.1	80 or more	YES
	95	DTC114YE		FRA	TL		150	10	47	50	0.07	68 or more	YES
	96	DTC124XE		FRA	TL		150	22	47	50	0.05	68 or more	YES
97	DTC143TE	FRA	TL	150	4.7	—	50	0.1	100 to 600	YES			
98	DTC114TE	FRA	TL	150	10	—	50	0.1	100 to 600	YES			
	99	DTA123EUB	*	HZG	TL	PNP	200	2.2	2.2	50	0.1	20 or more	YES
	100	DTA143EUB		HZG	TL		200	4.7	4.7	50	0.1	30 or more	YES
	101	DTA114EUB		HZG	TL		200	10	10	50	0.05	30 or more	YES
	102	DTA124EUB		HZG	TL		200	22	22	50	0.03	56 or more	YES
	103	DTA144EUB		HZG	TL		200	47	47	50	0.03	68 or more	YES
	104	DTA115EUB		HZG	TL		200	100	100	50	0.02	82 or more	YES
	105	DTA113ZUB		HZG	TL		200	1	10	50	0.1	33 or more	YES
	106	DTA123YUB		HZG	TL		200	2.2	10	50	0.1	33 or more	YES
	107	DTA123JUB		HZG	TL		200	2.2	47	50	0.1	80 or more	YES
	108	DTA143XUB		HZG	TL		200	4.7	10	50	0.1	30 or more	YES
	109	DTA143ZUB		HZG	TL		200	4.7	47	50	0.1	80 or more	YES
	110	DTA114YUB		HZG	TL		200	10	47	50	0.07	68 or more	YES
	111	DTA124XUB		HZG	TL		200	22	47	50	0.05	68 or more	YES
	112	DTA143TUB		HZG	TL		200	4.7	—	50	0.1	100 to 600	YES
	113	DTA114TUB		HZG	TL		200	10	—	50	0.1	100 to 600	YES
	114	DTC123EUB		HZG	TL		200	2.2	2.2	50	0.1	20 or more	YES
	115	DTC143EUB		HZG	TL		200	4.7	4.7	50	0.1	30 or more	YES
	116	DTC114EUB		HZG	TL		200	10	10	50	0.05	30 or more	YES
	117	DTC124EUB		HZG	TL		200	22	22	50	0.03	56 or more	YES
	118	DTC144EUB		HZG	TL		200	47	47	50	0.03	68 or more	YES
	119	DTC115EUB		HZG	TL		200	100	100	50	0.02	82 or more	YES
	120	DTC113ZUB		HZG	TL		200	1	10	50	0.1	33 or more	YES
	121	DTC123YUB		HZG	TL		200	2.2	10	50	0.1	33 or more	YES
	122	DTC123JUB		HZG	TL		200	2.2	47	50	0.1	80 or more	YES
	123	DTC143XUB		HZG	TL		200	4.7	10	50	0.1	30 or more	YES
	124	DTC143ZUB		HZG	TL		200	4.7	47	50	0.1	80 or more	YES
	125	DTC114YUB		HZG	TL		200	10	47	50	0.07	68 or more	YES
	126	DTC124XUB		HZG	TL		200	22	47	50	0.05	68 or more	YES
127	DTC143TUB	HZG	TL	200	4.7	—	50	0.1	100 to 600	YES			
128	DTC114TUB	HZG	TL	200	10	—	50	0.1	100 to 600	YES			

Notes1 : * : General part No. have no grade code.
 Notes2 : *1 With reference land installed.
 Notes3 : PNP (—) symbol omitted.
 Notes4 : Package is JEDEC code. () :ROHM Packages , [] :JEITA code

Digital Transistors

100mA Digital Transistors(For Automotive use)

Package	Quick Reference No.	Product No.				Polarity (ch)	P ₀ *1 (mW)	R1 (kΩ)	R2 (kΩ)	V _{CC} (V _{CEO}) (V)	I ₀ (I _C) (A)	GI (h _{FE})	Automotive Grade AEC-Q101
		Part No.	Grade Code		Taping Code								
			General	Automotive									
SOT-323 (UMT3) [SC-70] 2021 size	129	DTA123EUA	*	FRA	T106	PNP	200	2.2	2.2	50	0.1	20 or more	YES
	130	DTA143EUA	*	FRA	T106		200	4.7	4.7	50	0.1	30 or more	YES
	131	DTA114EUA	*	FRA	T106		200	10	10	50	0.05	30 or more	YES
	132	DTA124EUA	*	FRA	T106		200	22	22	50	0.03	56 or more	YES
	133	DTA144EUA	*	FRA	T106		200	47	47	50	0.03	68 or more	YES
	134	DTA115EUA	*	FRA	T106		200	100	100	50	0.02	82 or more	YES
	135	DTA113ZUA	*	FRA	T106		200	1	10	50	0.1	33 or more	YES
	136	DTA123YUA	*	FRA	T106		200	2.2	10	50	0.1	33 or more	YES
	137	DTA123JUA	*	FRA	T106		200	2.2	47	50	0.1	80 or more	YES
	138	DTA143XUA	*	FRA	T106		200	4.7	10	50	0.1	30 or more	YES
	139	DTA143ZUA	*	FRA	T106		200	4.7	47	50	0.1	80 or more	YES
	140	New DTA114WUA	*	FRA	T106		200	10	4.7	50	0.1	24 or more	YES
	141	DTA114YUA	*	FRA	T106		200	10	47	50	0.07	68 or more	YES
	142	DTA124XUA	*	FRA	T106		200	22	47	50	0.05	68 or more	YES
	143	DTA144WUA	*	FRA	T106		200	47	22	50	0.03	56 or more	YES
	144	New DTA123TUA	*	FRA	T106		200	2.2	—	50	0.1	100 to 600	YES
	145	DTA143TUA	*	FRA	T106		200	4.7	—	50	0.1	100 to 600	YES
	146	DTA114TUA	*	FRA	T106		200	10	—	50	0.1	100 to 600	YES
	147	DTA124TUA	*	FRA	T106		200	22	—	50	0.1	100 to 600	YES
	148	DTA144TUA	*	FRA	T106		200	47	—	50	0.1	100 to 600	YES
	149	DTA115TUA	*	FRA	T106		200	100	—	50	0.1	100 to 600	YES
	150	DTA114GUA	*	FRA	T106		200	—	10	50	0.1	30 or more	YES
	151	DTA144GUA	*	FRA	T106		200	—	47	50	0.1	68 or more	YES
	152	DTA115GUA	*	FRA	T106		200	—	100	50	0.1	82 or more	YES
	153	DTC123EUA	*	FRA	T106		200	2.2	2.2	50	0.1	20 or more	YES
	154	DTC143EUA	*	FRA	T106		200	4.7	4.7	50	0.1	30 or more	YES
	155	DTC114EUA	*	FRA	T106		200	10	10	50	0.05	30 or more	YES
	156	DTC124EUA	*	FRA	T106		200	22	22	50	0.03	56 or more	YES
	157	DTC144EUA	*	FRA	T106		200	47	47	50	0.03	68 or more	YES
	158	DTC115EUA	*	FRA	T106		200	100	100	50	0.02	82 or more	YES
	159	DTC113ZUA	*	FRA	T106		200	1	10	50	0.1	33 or more	YES
	160	DTC123YUA	*	FRA	T106		200	2.2	10	50	0.1	33 or more	YES
	161	DTC123JUA	*	FRA	T106		200	2.2	47	50	0.1	80 or more	YES
	162	DTC143XUA	*	FRA	T106		200	4.7	10	50	0.1	30 or more	YES
	163	DTC143ZUA	*	FRA	T106		200	4.7	47	50	0.1	80 or more	YES
	164	New DTC114WUA	*	FRA	T106		200	10	4.7	50	0.1	24 or more	YES
	165	DTC114YUA	*	FRA	T106		200	10	47	50	0.07	68 or more	YES
	166	DTC124XUA	*	FRA	T106		200	22	47	50	0.05	68 or more	YES
	167	DTC144WUA	*	FRA	T106		200	47	22	50	0.03	56 or more	YES
	168	New DTC123TUA	*	FRA	T106		200	2.2	—	50	0.1	100 to 600	YES
	169	DTC143TUA	*	FRA	T106		200	4.7	—	50	0.1	100 to 600	YES
	170	DTC114TUA	*	FRA	T106		200	10	—	50	0.1	100 to 600	YES
	171	DTC124TUA	*	FRA	T106		150	22	—	50	0.1	100 to 600	YES
	172	DTC144TUA	*	FRA	T106		200	47	—	50	0.1	100 to 600	YES
	173	DTC115TUA	*	FRA	T106		200	100	—	50	0.1	100 to 600	YES
	174	DTC114GUA	*	FRA	T106		200	—	10	50	0.1	30 or more	YES
	175	DTC124GUA	*	FRA	T106		200	—	22	50	0.1	56 or more	YES
176	DTC144GUA	*	FRA	T106	200	—	47	50	0.1	68 or more	YES		
177	DTC115GUA	*	FRA	T106	200	—	100	50	0.1	82 or more	YES		

Notes1 : * : General part No. have no grade code.

Notes2 : *1 With reference land installed.

Notes3 : PNP (—) symbol omitted.

Notes4 : Package is JEDEC code. () :ROHM Packages , [] :JEITA code

100mA Digital Transistors(For Automotive use)													
Package	Quick Reference No.	Product No.				Polarity (ch)	P _D *1 (mW)	R1 (kΩ)	R2 (kΩ)	V _{CC} (V _{CE0}) (V)	I ₀ (I _C) (A)	G1 (h _{FE})	Automotive Grade AEC-Q101
		Part No.	Grade Code		Taping Code								
			General	Automotive									
	178	☆DTA123EU3		HZG	T106	PNP	200	2.2	2.2	50	0.1	20 or more	YES
	179	☆DTA143EU3		HZG	T106		200	4.7	4.7	50	0.1	30 or more	YES
	180	☆DTA114EU3		HZG	T106		200	10	10	50	0.05	30 or more	YES
	181	☆DTA124EU3		HZG	T106		200	22	22	50	0.03	56 or more	YES
	182	☆DTA144EU3		HZG	T106		200	47	47	50	0.03	68 or more	YES
	183	☆DTA115EU3		HZG	T106		200	100	100	50	0.02	82 or more	YES
	184	☆DTA113ZU3		HZG	T106		200	1	10	50	0.1	33 or more	YES
	185	☆DTA123YU3		HZG	T106		200	2.2	10	50	0.1	33 or more	YES
	186	☆DTA123JU3		HZG	T106		200	2.2	47	50	0.1	80 or more	YES
	187	☆DTA143XU3		HZG	T106		200	4.7	10	50	0.1	30 or more	YES
	188	☆DTA143ZU3		HZG	T106		200	4.7	47	50	0.1	80 or more	YES
	189	☆DTA114YU3		HZG	T106		200	10	47	50	0.07	68 or more	YES
	190	☆DTA124XU3		HZG	T106		200	22	47	50	0.05	68 or more	YES
	191	☆DTA143TU3		HZG	T106		200	4.7	—	50	0.1	100 to 600	YES
	192	☆DTA114TU3		HZG	T106		200	10	—	50	0.1	100 to 600	YES
	193	☆DTC123EU3	*	HZG	T106		200	2.2	2.2	50	0.1	20 or more	YES
	194	☆DTC143EU3		HZG	T106		200	4.7	4.7	50	0.1	30 or more	YES
	195	☆DTC114EU3		HZG	T106		200	10	10	50	0.05	30 or more	YES
	196	☆DTC124EU3		HZG	T106		200	22	22	50	0.03	56 or more	YES
	197	☆DTC144EU3		HZG	T106		200	47	47	50	0.03	68 or more	YES
	198	☆DTC115EU3		HZG	T106		200	100	100	50	0.02	82 or more	YES
	199	☆DTC113ZU3		HZG	T106		200	1	10	50	0.1	33 or more	YES
	200	☆DTC123YU3		HZG	T106		200	2.2	10	50	0.1	33 or more	YES
	201	☆DTC123JU3		HZG	T106		200	2.2	47	50	0.1	80 or more	YES
	202	☆DTC143XU3		HZG	T106		200	4.7	10	50	0.1	30 or more	YES
	203	☆DTC143ZU3		HZG	T106		200	4.7	47	50	0.1	80 or more	YES
	204	☆DTC114YU3		HZG	T106		200	10	47	50	0.07	68 or more	YES
	205	☆DTC124XU3		HZG	T106		200	22	47	50	0.05	68 or more	YES
	206	☆DTC143TU3		HZG	T106		200	4.7	—	50	0.1	100 to 600	YES
207	☆DTC114TU3		HZG	T106	200	10	—	50	0.1	100 to 600	YES		
208	☆DTC114GU3		HZG	T106	200	—	10	50	0.1	30 or more	YES		
209	☆DTC115GU3		HZG	T106	200	—	100	50	0.1	82 or more	YES		
	210	DTA123ECA		HZG	T116	PNP	200	2.2	2.2	50	0.1	20 or more	YES
	211	DTA143ECA		HZG	T116		200	4.7	4.7	50	0.1	30 or more	YES
	212	DTA114ECA		HZG	T116		200	10	10	50	0.05	30 or more	YES
	213	DTA124ECA		HZG	T116		200	22	22	50	0.03	56 or more	YES
	214	DTA144ECA		HZG	T116		200	47	47	50	0.03	68 or more	YES
	215	DTA115ECA		HZG	T116		200	100	100	50	0.02	82 or more	YES
	216	DTA113ZCA		HZG	T116		200	1	10	50	0.1	33 or more	YES
	217	DTA123YCA		HZG	T116		200	2.2	10	50	0.1	33 or more	YES
	218	DTA123JCA		HZG	T116		200	2.2	47	50	0.1	80 or more	YES
	219	DTA143XCA		HZG	T116		200	4.7	10	50	0.1	30 or more	YES
	220	DTA143ZCA		HZG	T116		200	4.7	47	50	0.1	80 or more	YES
	221	DTA114YCA		HZG	T116		200	10	47	50	0.07	68 or more	YES
	222	DTA124XCA		HZG	T116		200	22	47	50	0.05	68 or more	YES
	223	New DTA144VCA		HZG	T116		200	47	10	50	0.03	33 or more	YES
	224	New DTA144WCA		HZG	T116		200	47	22	50	0.03	56 or more	YES
	225	New DTA123TCA		HZG	T116		200	2.2	—	50	0.1	100 to 600	YES
	226	DTA143TCA		HZG	T116		200	4.7	—	50	0.1	100 to 600	YES
	227	DTA114TCA		HZG	T116		200	10	—	50	0.1	100 to 600	YES
	228	New DTA124TCA		HZG	T116		200	22	—	50	0.1	100 to 600	YES
	229	New DTA144TCA		HZG	T116		200	47	—	50	0.1	100 to 600	YES
	230	New DTA115TCA		HZG	T116		200	100	—	50	0.1	100 to 600	YES
	231	DTC123ECA	*	HZG	T116		200	2.2	2.2	50	0.1	20 or more	YES
	232	DTC143ECA		HZG	T116		200	4.7	4.7	50	0.1	30 or more	YES
	233	DTC114ECA		HZG	T116		200	10	10	50	0.05	30 or more	YES
	234	DTC124ECA		HZG	T116		200	22	22	50	0.03	56 or more	YES
	235	DTC144ECA		HZG	T116		200	47	47	50	0.03	68 or more	YES
	236	DTC115ECA		HZG	T116		200	100	100	50	0.02	82 or more	YES
	237	DTC113ZCA		HZG	T116		200	1	10	50	0.1	33 or more	YES
	238	DTC123YCA		HZG	T116		200	2.2	10	50	0.1	33 or more	YES
	239	DTC123JCA		HZG	T116		200	2.2	47	50	0.1	80 or more	YES
	240	DTC143XCA		HZG	T116		200	4.7	10	50	0.1	30 or more	YES
	241	DTC143ZCA		HZG	T116		200	4.7	47	50	0.1	80 or more	YES
	242	DTC114YCA		HZG	T116		200	10	47	50	0.07	68 or more	YES
	243	DTC124XCA		HZG	T116		200	22	47	50	0.05	68 or more	YES
	244	New DTC144VCA		HZG	T116		200	47	10	50	0.03	33 or more	YES
	245	New DTC144WCA		HZG	T116		200	47	22	50	0.03	56 or more	YES
246	New DTC123TCA		HZG	T116	200	2.2	—	50	0.1	100 to 600	YES		
247	DTC143TCA		HZG	T116	200	4.7	—	50	0.1	100 to 600	YES		
248	DTC114TCA		HZG	T116	200	10	—	50	0.1	100 to 600	YES		
249	New DTC124TCA		HZG	T116	200	22	—	50	0.1	100 to 600	YES		
250	New DTC144TCA		HZG	T116	200	47	—	50	0.1	100 to 600	YES		
251	New DTC115TCA		HZG	T116	200	100	—	50	0.1	100 to 600	YES		

Notes1 : * : General part No. have no grade code.
 Notes2 : *1 With reference land installed.
 Notes3 : PNP (—) symbol omitted.
 Notes4 : Package is JEDEC code. () :ROHM Packages , [] :JEITA code

☆ : Under Development

Digital Transistors

100mA Digital Transistors(For Automotive use)													
Package	Quick Reference No.	Product No.				Polarity (ch)	P _D *1 (mW)	R1 (kΩ)	R2 (kΩ)	V _{CC} (V _{CEO}) (V)	I _O (I _C) (A)	GI (h _{FE})	Automotive Grade AEC-Q101
		Part No.	Grade Code		Taping Code								
			General	Automotive									
<p>SOT-346 (SMT3) [SC-59] 2928 size</p>	252	DTA123EKA	*	FRA	T146	PNP	200	2.2	2.2	50	0.1	20 or more	YES*2
	253	DTA143EKA		FRA	T146		200	4.7	4.7	50	0.1	30 or more	YES*2
	254	DTA114EKA		FRA	T146		200	10	10	50	0.05	30 or more	YES*2
	255	DTA124EKA		FRA	T146		200	22	22	50	0.03	56 or more	YES*2
	256	DTA144EKA		FRA	T146		200	47	47	50	0.03	68 or more	YES*2
	257	DTA115EKA		FRA	T146		200	100	100	50	0.02	82 or more	YES*2
	258	DTA113ZKA		FRA	T146		200	1	10	50	0.1	33 or more	YES*2
	259	DTA123YKA		FRA	T146		200	2.2	10	50	0.1	33 or more	YES*2
	260	DTA123JKA		FRA	T146		200	2.2	47	50	0.1	80 or more	YES*2
	261	DTA143XKA		FRA	T146		200	4.7	10	50	0.1	30 or more	YES*2
	262	DTA143ZKA		FRA	T146		200	4.7	47	50	0.1	80 or more	YES*2
	263	DTA114YKA		FRA	T146		200	10	47	50	0.07	68 or more	YES*2
	264	DTA124XKA		—	T146		200	22	47	50	0.05	68 or more	—
	265	DTA143TKA		FRA	T146		200	4.7	—	50	0.1	100 to 600	YES*2
	266	DTA114TKA		FRA	T146		200	10	—	50	0.1	100 to 600	YES*2
	267	DTC123EKA		FRA	T146		200	2.2	2.2	50	0.1	20 or more	YES*2
	268	DTC143EKA		FRA	T146		200	4.7	4.7	50	0.1	30 or more	YES*2
	269	DTC114EKA		FRA	T146		200	10	10	50	0.05	30 or more	YES*2
	270	DTC124EKA		FRA	T146		200	22	22	50	0.03	56 or more	YES*2
	271	DTC144EKA		FRA	T146		200	47	47	50	0.03	68 or more	YES*2
	272	DTC115EKA		FRA	T146		200	100	100	50	0.02	82 or more	YES*2
	273	DTC113ZKA		FRA	T146		200	1	10	50	0.1	33 or more	YES*2
	274	DTC123YKA		—	T146		200	2.2	10	50	0.1	33 or more	—
	275	DTC123JKA		FRA	T146		200	2.2	47	50	0.1	80 or more	YES*2
	276	DTC143XKA		FRA	T146		200	4.7	10	50	0.1	30 or more	YES*2
	277	DTC143ZKA		FRA	T146		200	4.7	47	50	0.1	80 or more	YES*2
	278	DTC114YKA		FRA	T146		200	10	47	50	0.07	68 or more	YES*2
	279	DTC124XKA		FRA	T146		200	22	47	50	0.05	68 or more	YES*2
	280	DTC143TKA		FRA	T146		200	4.7	—	50	0.1	100 to 600	YES*2
	281	DTC114TKA		—	T146		200	10	—	50	0.1	100 to 600	—

Notes1 : * : General part No. have no grade code.
 Notes2 : *1 With reference land installed.
 Notes3 : *2 Not recommended for a new design.
 Notes4 : PNP (—) symbol omitted.
 Notes5 : Package is JEDEC code. () :ROHM Packages , [] :JEITA code

Quick Reference for 100mA Digital Transistors(For Consumer only)													
Item	Part No.		R1 (kΩ)	R2 (kΩ)	Package						V _{CC} (V _{CE0}) (V)	I ₀ (I _C) (A)	G _I (h _{FE})
	PNP	NPN			SOT-723 (VMT3) [SC-105AA] 1212 size		SOT-416FL (EMT3F) [SC-89] 1616 size		SOT-323FL (UMT3F) [SC-85] 2021 size				
	P _D =150mW*				P _D =200mW*								
	PNP	NPN			PNP	NPN	PNP	NPN	PNP	NPN			
Quick Reference No.													
R1=R2 Potential Divider type	DTA023Ex	DTC023Ex	2.2	2.2	1	18	35	52	69	86	50	0.1	20 or more
	DTA043Ex	DTC043Ex	4.7	4.7	2	19	36	53	70	87		0.1	20 or more
	DTA014Ex	DTC014Ex	10	10	3	20	37	54	71	88		0.05	35 or more
	DTA024Ex	DTC024Ex	22	22	4	21	38	55	72	89		0.03	60 or more
	DTA044Ex	DTC044Ex	47	47	5	22	39	56	73	90		0.03	80 or more
	DTA015Ex	DTC015Ex	100	100	6	23	40	57	74	91		0.02	80 or more
R1≠R2 Leak Absorption type	DTA013Zx	DTC013Zx	1	10	7	24	41	58	75	92		0.1	30 or more
	DTA023Yx	DTC023Yx	2.2	10	8	25	42	59	76	93		0.1	35 or more
	DTA023Jx	DTC023Jx	2.2	47	9	26	43	60	77	94		0.1	80 or more
	DTA043Xx	DTC043Xx	4.7	10	10	27	44	61	78	95		0.1	35 or more
	DTA043Zx	DTC043Zx	4.7	47	11	28	45	62	79	96		0.1	80 or more
	DTA014Yx	DTC014Yx	10	47	12	29	46	63	80	97		0.07	80 or more
	DTA024Xx	DTC024Xx	22	47	13	30	47	64	81	98	0.05	80 or more	
Type Using R1 Alone as Input Resistor	DTA043Tx	DTC043Tx	4.7	—	14	31	48	65	82	99	0.1	100 to 600	
	DTA014Tx	DTC014Tx	10	—	15	32	49	66	83	100	0.1	100 to 600	
	DTA044Tx	DTC044Tx	47	—	16	33	50	67	84	101	0.06	100 to 600	
	DTA015Tx	DTC015Tx	100	—	17	34	51	68	85	102	0.1	100 to 600	
x : Packaging designation symbol					M		EB		UB				

Notes1 : PNP (—) symbol omitted.
 Notes2 : * With reference land installed.
 Notes3 : Package is JEDEC code. () :ROHM Packages , [] :JEITA code

Digital Transistors

100mA Digital Transistors(For Consumer only)													
Package	Product No.					Polarity (ch)	P ₀ *1 (mW)	R1 (kΩ)	R2 (kΩ)	V _{CC} (V _{CE0}) (V)	I ₀ (I _C) (A)	GI (h _{FE})	Automotive Grade AEC-Q101
	Quick Reference No.	Part No.	Grade Code		Taping Code								
			General	Automotive									
SOT-723 (VMT3) [SC-105AA] 1212 size	1	DTA023EM	—	—	T2L	PNP	150	2.2	2.2	50	0.1	20 or more	—
	2	DTA043EM	—	—	T2L		150	4.7	4.7	50	0.1	20 or more	—
	3	DTA014EM	—	—	T2L		150	10	10	50	0.05	35 or more	—
	4	DTA024EM	—	—	T2L		150	22	22	50	0.03	60 or more	—
	5	DTA044EM	—	—	T2L		150	47	47	50	0.03	80 or more	—
	6	DTA015EM	—	—	T2L		150	100	100	50	0.02	80 or more	—
	7	DTA013ZM	—	—	T2L		150	1	10	50	0.1	30 or more	—
	8	DTA023YM	—	—	T2L		150	2.2	10	50	0.1	35 or more	—
	9	DTA023JM	—	—	T2L		150	2.2	47	50	0.1	80 or more	—
	10	DTA043XM	—	—	T2L		150	4.7	10	50	0.1	35 or more	—
	11	DTA043ZM	—	—	T2L		150	4.7	47	50	0.1	80 or more	—
	12	DTA014YM	—	—	T2L		150	10	47	50	0.07	80 or more	—
	13	DTA024XM	—	—	T2L		150	22	47	50	0.05	80 or more	—
	14	DTA043TM	—	—	T2L		150	4.7	—	50	0.1	100 to 600	—
	15	DTA014TM	—	—	T2L		150	10	—	50	0.1	100 to 600	—
	16	DTA044TM	—	—	T2L		150	47	—	50	0.06	100 to 600	—
	17	DTA015TM	—	—	T2L		150	100	—	50	0.1	100 to 600	—
	18	DTC023EM	—	—	T2L		150	2.2	2.2	50	0.1	20 or more	—
	19	DTC043EM	—	—	T2L	150	4.7	4.7	50	0.1	20 or more	—	
	20	DTC014EM	—	—	T2L	150	10	10	50	0.05	35 or more	—	
	21	DTC024EM	—	—	T2L	150	22	22	50	0.03	60 or more	—	
	22	DTC044EM	—	—	T2L	150	47	47	50	0.03	80 or more	—	
	23	DTC015EM	—	—	T2L	150	100	100	50	0.02	80 or more	—	
	24	DTC013ZM	—	—	T2L	150	1	10	50	0.1	30 or more	—	
	25	DTC023YM	—	—	T2L	150	2.2	10	50	0.1	35 or more	—	
	26	DTC023JM	—	—	T2L	150	2.2	47	50	0.1	80 or more	—	
	27	DTC043XM	—	—	T2L	150	4.7	10	50	0.1	35 or more	—	
	28	DTC043ZM	—	—	T2L	150	4.7	47	50	0.1	80 or more	—	
	29	DTC014YM	—	—	T2L	150	10	47	50	0.07	80 or more	—	
	30	DTC024XM	—	—	T2L	150	22	47	50	0.05	80 or more	—	
	31	DTC043TM	—	—	T2L	150	4.7	—	50	0.1	100 to 600	—	
	32	DTC014TM	—	—	T2L	150	10	—	50	0.1	100 to 600	—	
	33	DTC044TM	—	—	T2L	150	47	—	50	0.06	100 to 600	—	
	34	DTC015TM	—	—	T2L	150	100	—	50	0.1	100 to 600	—	
SOT-416FL (EMT3F) [SC-89] 1616 size	35	DTA023EEB	—	—	TL	PNP	150	2.2	2.2	50	0.1	20 or more	—
	36	DTA043EEB	—	—	TL		150	4.7	4.7	50	0.1	20 or more	—
	37	DTA014EEB	—	—	TL		150	10	10	50	0.05	35 or more	—
	38	DTA024EEB	—	—	TL		150	22	22	50	0.03	60 or more	—
	39	DTA044EEB	—	—	TL		150	47	47	50	0.03	80 or more	—
	40	DTA015EEB	—	—	TL		150	100	100	50	0.02	80 or more	—
	41	DTA013ZEB	—	—	TL		150	1	10	50	0.1	30 or more	—
	42	DTA023YEB	—	—	TL		150	2.2	10	50	0.1	35 or more	—
	43	DTA023JEB	—	—	TL		150	2.2	47	50	0.1	80 or more	—
	44	DTA043XEB	—	—	TL		150	4.7	10	50	0.1	35 or more	—
	45	DTA043ZEB	—	—	TL		150	4.7	47	50	0.1	80 or more	—
	46	DTA014YEB	—	—	TL		150	10	47	50	0.07	80 or more	—
	47	DTA024XEB	—	—	TL		150	22	47	50	0.05	80 or more	—
	48	DTA043TEB	—	—	TL		150	4.7	—	50	0.1	100 to 600	—
	49	DTA014TEB	—	—	TL		150	10	—	50	0.1	100 to 600	—
	50	DTA044TEB	—	—	TL		150	47	—	50	0.06	100 to 600	—
	51	DTA015TEB	—	—	TL		150	100	—	50	0.1	100 to 600	—
	52	DTC023EEB	—	—	TL		150	2.2	2.2	50	0.1	20 or more	—
	53	DTC043EEB	—	—	TL	150	4.7	4.7	50	0.1	20 or more	—	
	54	DTC014EEB	—	—	TL	150	10	10	50	0.05	35 or more	—	
	55	DTC024EEB	—	—	TL	150	22	22	50	0.03	60 or more	—	
	56	DTC044EEB	—	—	TL	150	47	47	50	0.03	80 or more	—	
	57	DTC015EEB	—	—	TL	150	100	100	50	0.02	80 or more	—	
	58	DTC013ZEB	—	—	TL	150	1	10	50	0.1	30 or more	—	
	59	DTC023YEB	—	—	TL	150	2.2	10	50	0.1	35 or more	—	
	60	DTC023JEB	—	—	TL	150	2.2	47	50	0.1	80 or more	—	
	61	DTC043XEB	—	—	TL	150	4.7	10	50	0.1	35 or more	—	
	62	DTC043ZEB	—	—	TL	150	4.7	47	50	0.1	80 or more	—	
	63	DTC014YEB	—	—	TL	150	10	47	50	0.07	80 or more	—	
	64	DTC024XEB	—	—	TL	150	22	47	50	0.05	80 or more	—	
	65	DTC043TEB	—	—	TL	150	4.7	—	50	0.1	100 to 600	—	
	66	DTC014TEB	—	—	TL	150	10	—	50	0.1	100 to 600	—	
	67	DTC044TEB	—	—	TL	150	47	—	50	0.06	100 to 600	—	
	68	DTC015TEB	—	—	TL	150	100	—	50	0.1	100 to 600	—	

Notes1 : * : General part No. have no grade code.

Notes2 : *1 With reference land installed.

Notes3 : PNP (—) symbol omitted.

Notes4 : Package is JEDEC code. () :ROHM Packages , [] :JEITA code

100mA Digital Transistors(For Consumer only)													
Package	Product No.					Polarity (ch)	P ₀ *1 (mW)	R1 (kΩ)	R2 (kΩ)	V _{CC} (V _{CE0}) (V)	I ₀ (I _C) (A)	G _I (h _{FE})	Automotive Grade AEC-Q101
	Quick Reference No.	Part No.	Grade Code		Taping Code								
			General	Automotive									
<p>SOT-323FL (UMT3F) [SC-85] 2021 size</p>	69	DTA023EUB	—	—	TL	PNP	200	2.2	2.2	50	0.1	20 or more	—
	70	DTA043EUB	—	—	TL		200	4.7	4.7	50	0.1	20 or more	—
	71	DTA014EUB	—	—	TL		200	10	10	50	0.05	35 or more	—
	72	DTA024EUB	—	—	TL		200	22	22	50	0.03	60 or more	—
	73	DTA044EUB	—	—	TL		200	47	47	50	0.03	80 or more	—
	74	DTA015EUB	—	—	TL		200	100	100	50	0.02	80 or more	—
	75	DTA013ZUB	—	—	TL		200	1	10	50	0.1	30 or more	—
	76	DTA023YUB	—	—	TL		200	2.2	10	50	0.1	35 or more	—
	77	DTA023JUB	—	—	TL		200	2.2	47	50	0.1	80 or more	—
	78	DTA043XUB	—	—	TL		200	4.7	10	50	0.1	35 or more	—
	79	DTA043ZUB	—	—	TL		200	4.7	47	50	0.1	80 or more	—
	80	DTA014YUB	—	—	TL		200	10	47	50	0.07	80 or more	—
	81	DTA024XUB	—	—	TL		200	22	47	50	0.05	80 or more	—
	82	DTA043TUB	—	—	TL		200	4.7	—	50	0.1	100 to 600	—
	83	DTA014TUB	—	—	TL		200	10	—	50	0.1	100 to 600	—
	84	DTA044TUB	—	—	TL		200	47	—	50	0.06	100 to 600	—
	85	DTA015TUB	—	—	TL	200	100	—	50	0.1	100 to 600	—	
	86	DTC023EUB	—	—	TL	NPN	200	2.2	2.2	50	0.1	20 or more	—
	87	DTC043EUB	—	—	TL		200	4.7	4.7	50	0.1	20 or more	—
	88	DTC014EUB	—	—	TL		200	10	10	50	0.05	35 or more	—
	89	DTC024EUB	—	—	TL		200	22	22	50	0.03	60 or more	—
	90	DTC044EUB	—	—	TL		200	47	47	50	0.03	80 or more	—
	91	DTC015EUB	—	—	TL		200	100	100	50	0.02	80 or more	—
	92	DTC013ZUB	—	—	TL		200	1	10	50	0.1	30 or more	—
	93	DTC023YUB	—	—	TL		200	2.2	10	50	0.1	35 or more	—
	94	DTC023JUB	—	—	TL		200	2.2	47	50	0.1	80 or more	—
	95	DTC043XUB	—	—	TL		200	4.7	10	50	0.1	35 or more	—
	96	DTC043ZUB	—	—	TL		200	4.7	47	50	0.1	80 or more	—
	97	DTC014YUB	—	—	TL		200	10	47	50	0.07	80 or more	—
	98	DTC024XUB	—	—	TL		200	22	47	50	0.05	80 or more	—
	99	DTC043TUB	—	—	TL		200	4.7	—	50	0.1	100 to 600	—
	100	DTC014TUB	—	—	TL		200	10	—	50	0.1	100 to 600	—
101	DTC044TUB	—	—	TL	200		47	—	50	0.06	100 to 600	—	
102	DTC015TUB	—	—	TL	200	100	—	50	0.1	100 to 600	—		

Notes1 : * : General part No. have no grade code.
 Notes2 : *1 With reference land installed.
 Notes3 : PNP (—) symbol omitted.
 Notes4 : Package is JEDEC code. () :ROHM Packages , [] :JEITA code

Digital Transistors

Quick Reference for 500mA Digital Transistors															
Item	Part No.		R1 (kΩ)	R2 (kΩ)	Package						V _{CC} (V _{CEO}) (V)	I _o (I _c) (A)	G _I (h _{FE})		
	PNP	NPN			SOT-323 (UMT3) [SC-70] 2021 size		SOT-23 (SST3) 2924 size		SOT-346 (SMT3) [SC-59] 2928 size						
	P _D =200mW*						PNP		NPN						
	Quick Reference No.														
R1=R2 Potential Divider type	DTB113Ex	DTD113Ex	1	1	☆1	☆9	17	25	33	41	50	0.5	33 or more		
	DTB123Ex	DTD123Ex	2.2	2.2	☆2	☆10	18	26	34	42			39 or more		
	DTB143Ex	DTD143Ex	4.7	4.7	☆3	☆11	19	27	35	43			47 or more		
	DTB114Ex	DTD114Ex	10	10	☆4	☆12	20	28	36	44			56 or more		
R1≠R2 Leak Absorption type	DTB113Zx	DTD113Zx	1	10	☆5	☆13	21	29	37	45			56 or more		
Type Using R2 Alone as Bleeder Resistor	DTB114Gx	DTD114Gx	—	10	☆7	☆15	23	31	39	47	56 or more				
Type Using R1 Alone as Input Resistor	DTB123Tx	DTD123Tx	2.2	—	☆8	☆16	24	32	40	48	40	100 to 600			
x : Packaging designation symbol					U		C		K						

Notes1 : PNP (—) symbol omitted. Notes2 : * With reference land installed. Notes3 : Package is JEDEC code. () :ROHM Packages , [] :JEITA code

☆ : Under Development

500mA Digital Transistors													
Package	Quick Reference No.	Product No.			Polarity (ch)	P _D *1 (mW)	R1 (kΩ)	R2 (kΩ)	V _{CC} (V _{CEO}) (V)	I _o (I _c) (A)	G _I (h _{FE})	Automotive Grade AEC-Q101	
		Part No.	Grade Code	Taping Code									
		General	Automotive										
	1	☆DTB113EU	—	T106	PNP	200	1	1	50	0.5	33 or more	—	
	2	☆DTB123EU	—	T106		200	2.2	2.2	50	0.5	39 or more	—	
	3	☆DTB143EU	—	T106		200	4.7	4.7	50	0.5	47 or more	—	
	4	☆DTB114EU	—	T106		200	10	10	50	0.5	56 or more	—	
	5	☆DTB113ZU	—	T106		200	1	10	50	0.5	56 or more	—	
	6	☆DTB123YU	—	T106		200	2.2	10	50	0.5	56 or more	—	
	7	☆DTB114GU	—	T106		200	—	10	50	0.5	56 or more	—	
	8	☆DTB123TU	—	T106		200	2.2	—	40	0.5	100 to 600	—	
		9	☆DTD113EU	*	T106	NPN	200	1	1	50	0.5	33 or more	—
		10	☆DTD123EU	—	T106		200	2.2	2.2	50	0.5	39 or more	—
		11	☆DTD143EU	—	T106		200	4.7	4.7	50	0.5	47 or more	—
		12	☆DTD114EU	—	T106		200	10	10	50	0.5	56 or more	—
		13	☆DTD113ZU	—	T106		200	1	10	50	0.5	56 or more	—
		14	☆DTD123YU	—	T106		200	2.2	10	50	0.5	56 or more	—
		15	☆DTD114GU	—	T106		200	—	10	50	0.5	56 or more	—
		16	☆DTD123TU	—	T106		200	2.2	—	40	0.5	100 to 600	—
		17	DTB113EC	—	T116	PNP	200	1	1	50	0.5	33 or more	YES
		18	DTB123EC	—	T116		200	2.2	2.2	50	0.5	39 or more	YES
		19	DTB143EC	—	T116		200	4.7	4.7	50	0.5	47 or more	YES
		20	DTB114EC	—	T116		200	10	10	50	0.5	56 or more	YES
		21	DTB113ZC	—	T116		200	1	10	50	0.5	56 or more	YES
		22	DTB123YC	—	T116		200	2.2	10	50	0.5	56 or more	YES
		23	DTB114GC	—	T116		200	—	10	50	0.5	56 or more	YES
		24	DTB123TC	—	T116		200	2.2	—	40	0.5	100 to 600	YES
		25	DTD113EC	*	T116	NPN	200	1	1	50	0.5	33 or more	YES
		26	DTD123EC	—	T116		200	2.2	2.2	50	0.5	39 or more	YES
		27	DTD143EC	—	T116		200	4.7	4.7	50	0.5	47 or more	YES
		28	DTD114EC	—	T116		200	10	10	50	0.5	56 or more	YES
		29	DTD113ZC	—	T116		200	1	10	50	0.5	56 or more	YES
		30	DTD123YC	—	T116		200	2.2	10	50	0.5	56 or more	YES
		31	DTD114GC	—	T116		200	—	10	50	0.5	56 or more	YES
		32	DTD123TC	—	T116		200	2.2	—	40	0.5	100 to 600	YES
		33	DTB113EK	—	T146	PNP	200	1	1	50	0.5	33 or more	YES*2
		34	DTB123EK	—	T146		200	2.2	2.2	50	0.5	39 or more	YES*2
		35	DTB143EK	—	T146		200	4.7	4.7	50	0.5	47 or more	YES*2
		36	DTB114EK	—	T146		200	10	10	50	0.5	56 or more	YES*2
		37	DTB113ZK	—	T146		200	1	10	50	0.5	56 or more	YES*2
		38	DTB123YK	—	T146		200	2.2	10	50	0.5	56 or more	YES*2
		39	DTB114GK	—	T146		200	—	10	50	0.5	56 or more	—
		40	DTB123TK	—	T146		200	2.2	—	40	0.5	100 to 600	—
		41	DTD113EK	*	T146	NPN	200	1	1	50	0.5	33 or more	YES*2
		42	DTD123EK	—	T146		200	2.2	2.2	50	0.5	39 or more	YES*2
		43	DTD143EK	—	T146		200	4.7	4.7	50	0.5	47 or more	YES*2
		44	DTD114EK	—	T146		200	10	10	50	0.5	56 or more	YES*2
		45	DTD113ZK	—	T146		200	1	10	50	0.5	56 or more	YES*2
		46	DTD123YK	—	T146		200	2.2	10	50	0.5	56 or more	YES*2
		47	DTD114GK	—	T146		200	—	10	50	0.5	56 or more	—
		48	DTD123TK	—	T146		200	2.2	—	40	0.5	100 to 600	—

Notes1 : * : General part No. have no grade code. Notes2 : *1 With reference land installed. Notes3 : *2 Not recommended for a new design. Notes4 : PNP (—) symbol omitted. Notes5 : Package is JEDEC code. () :ROHM Packages , [] :JEITA code

☆ : Under Development

Quick Reference for 12V/500mA Digital Transistors													
Item	Part No.		R1 (kΩ)	R2 (kΩ)	Package				V _{CC} (V _{CE0}) (V)	I _O (I _C) (A)	G _I (h _{FE})		
	PNP	NPN			SOT-723 (VMT3) [SC-105AA] 1212 size		SOT-416 (EMT3) [SC-75A] 1616 size						
	P _D =150mW*				PNP	NPN	PNP	NPN					
	Quick Reference No.												
R1=R2 Potential Divider type	DTB543Ex	DTD543Ex	4.7	4.7	1	6	11	16	12	0.5	115 or more		
R1≠R2 Leak Absorption type	DTB513Zx	DTD513Zx	1	10	2	7	12	17			140 or more		
	DTB523Yx	DTD523Yx	2.2	10	3	8	13	18			140 or more		
	DTB543Xx	DTD543Xx	4.7	10	4	9	14	19			140 or more		
	DTB543Zx	DTD543Zx	4.7	47	5	10	15	20			140 or more		
x : Packaging designation symbol					M			E					

Notes1 : PNP (-) symbol omitted.
 Notes2 : * With reference land installed.
 Notes3 : Package is JEDEC code. () :ROHM Packages , [] :JEITA code

Package	Product No.					Polarity (ch)	P _O *1 (mW)	R1 (kΩ)	R2 (kΩ)	V _{CC} (V _{CE0}) (V)	I _O (I _C) (A)	G _I (h _{FE})	Automotive Grade AEC-Q101
	Quick Reference No.	Part No.	Grade Code		Taping Code								
			General	Automotive									
SOT-723 (VMT3) [SC-105AA] 1212 size	1	DTB543EM	*	—	T2L	PNP	150	4.7	4.7	12	0.5	115 or more	—
	2	DTB513ZM	*	—	T2L		150	1	10	12	0.5	140 or more	—
	3	DTB523YM	*	—	T2L		150	2.2	10	12	0.5	140 or more	—
	4	DTB543XM	*	—	T2L		150	4.7	10	12	0.5	140 or more	—
	5	DTB543ZM	*	—	T2L		150	4.7	47	12	0.5	140 or more	—
	6	DTD543EM	*	—	T2L	NPN	150	4.7	4.7	12	0.5	115 or more	—
	7	DTD513ZM	*	—	T2L		150	1	10	12	0.5	140 or more	—
	8	DTD523YM	*	—	T2L		150	2.2	10	12	0.5	140 or more	—
	9	DTD543XM	*	—	T2L		150	4.7	10	12	0.5	140 or more	—
	10	DTD543ZM	*	—	T2L		150	4.7	47	12	0.5	140 or more	—
SOT-416 (EMT3) [SC-75A] 1616 size	11	DTB543EE	*	—	TL	PNP	150	4.7	4.7	12	0.5	115 or more	—
	12	DTB513ZE	*	—	TL		150	1	10	12	0.5	140 or more	—
	13	DTB523YE	*	—	TL		150	2.2	10	12	0.5	140 or more	—
	14	DTB543XE	*	—	TL		150	4.7	10	12	0.5	140 or more	—
	15	DTB543ZE	*	—	TL		150	4.7	47	12	0.5	140 or more	—
	16	DTD543EE	*	—	TL	NPN	150	4.7	4.7	12	0.5	115 or more	—
	17	DTD513ZE	*	—	TL		150	1	10	12	0.5	140 or more	—
	18	DTD523YE	*	—	TL		150	2.2	10	12	0.5	140 or more	—
	19	DTD543XE	*	—	TL		150	4.7	10	12	0.5	140 or more	—
	20	DTD543ZE	*	—	TL		150	4.7	47	12	0.5	140 or more	—

Notes1 : * : General part No. have no grade code.
 Notes2 : *1 With reference land installed.
 Notes3 : PNP (-) symbol omitted.
 Notes4 : Package is JEDEC code. () :ROHM Packages , [] :JEITA code

Digital Transistors

Quick Reference for Muting Digital Transistors											
Item	Part No.		R1 (kΩ)	R2 (kΩ)	Package			V _{CC} (V _{CE0}) (V)	I ₀ (I _C) (A)	G _I (h _{FE})	
	PNP	NPN			SOT-323FL (UMT3F) [SC-85] 2021 size	SOT-323 (UMT3) [SC-70] 2021 size	SOT-346 (SMT3) [SC-59] 2928 size				
Specifications	—		—	—				—	—	—	
	P _D =200mW*										
Type Using R1 Alone as Input Resistor	—	DTC623Tx	2.2	—				20	0.6	820 to 2700	
	—	DTC643Tx	4.7	—						820 to 2700	
	—	DTC614Tx	10	—						820 to 2700	
	—	DTC923TUB	2.2	—	DTC923TUB			40 (V _{EBO})	0.4	820 to 2700	
	—	DTC943TUB	4.7	—	DTC943TUB					820 to 2700	
—	DTC914TUB	10	—	DTC914TUB			820 to 2700				
	x : Packaging designation symbol				UB	U	K				

Notes1 : * With reference land installed.
Notes2 : Package is JEDEC code. () :ROHM Packages , [] :JEITA code

Muting Digital Transistors												
Package	Product No.				Polarity (ch)	P _D *1 (mW)	R1 (kΩ)	R2 (kΩ)	V _{CC} (V _{CE0}) (V)	I ₀ (I _C) (A)	G _I (h _{FE})	Automotive Grade AEC-Q101
	Part No.	Grade Code		Taping Code								
		General	Automotive									
	DTC923TUB	*	—	TL	NPN	200	2.2	—	40 (V _{EBO})	0.4	820 to 2700	—
	DTC943TUB	*	—	TL		200	4.7	—	40 (V _{EBO})	0.4	820 to 2700	—
	DTC914TUB	*	—	TL		200	10	—	40 (V _{EBO})	0.4	820 to 2700	—
	DTC623TU	*	—	T106	NPN	200	2.2	—	20	0.6	820 to 2700	—
	DTC643TU	*	—	T106		200	4.7	—	20	0.6	820 to 2700	—
	DTC614TU	*	—	T106		200	10	—	20	0.6	820 to 2700	—
	DTC623TK	*	—	T146	NPN	200	2.2	—	20	0.6	820 to 2700	—
	DTC643TK	*	—	T146		200	4.7	—	20	0.6	820 to 2700	—
	DTC614TK	*	—	T146		200	10	—	20	0.6	820 to 2700	—

Notes1 : * : General part No. have no grade code.
Notes2 : *1 With reference land installed.
Notes3 : Package is JEDEC code. () :ROHM Packages , [] :JEITA code

Quick Reference for Power Digital Transistors											
Item	Part No.		R1 (kΩ)	R2 (kΩ)	Package	V _{CC} (V _{CE0}) (V)	I ₀ (I _C) (A)	G _I (h _{FE})			
	PNP	NPN									
Specifications	—		—	—	SOT-89 (MPT3) [SC-62] 4540 size 	—	—	—			
	P ₀ =0.5W*										
Driver	—	DTDG23YP	2.2	10	DTDG23YP	60±10	1	300 or more			
	—	DTDG14GP	—	10	DTDG14GP			300 or more			

Notes1 : * With reference land installed.
Notes2 : For internal circuit, please see the technical specifications.
Notes3 : Package is JEDEC code. () :ROHM Packages , [] :JEITA code

Power Digital Transistors												
Package	Product No.				Polarity (ch)	P _D *1 (W)	R1 (kΩ)	R2 (kΩ)	V _{CC} (V _{CE0}) (V)	I ₀ (I _C) (A)	G _I (h _{FE})	Automotive Grade AEC-Q101
	Part No.	Grade Code		Taping Code								
		General	Automotive									
	DTDG23YP	*	FRA	T100	NPN	0.5	2.2	10	60±10	1	300 or more	YES
	DTDG14GP	*	FRA	T100		0.5	—	10	60±10	1	300 or more	YES

Notes1 : * : General part No. have no grade code.
Notes2 : *1 With reference land installed.
Notes3 : For internal circuit, please see the technical specifications.
Notes4 : Package is JEDEC code. () :ROHM Packages , [] :JEITA code

Complex Digital Transistors

Quick Reference for 100mA Complex Digital Transistors(Including Automotive use)									
Configuration	Equivalent Circuit Diagram (TOP View)	SOT-563 (EMT6) [SC-107C] 1616 size	SOT-363 (UMT6) [SC-88] 2021 size	SOT-457 (SMT6) [SC-74] 2928 size	Equivalent Element Transistors	R1 (kΩ)	R2 (kΩ)	V _{CC} (V _{CE0}) (V)	I _o (I _c) (A)
PNP×2		EMB10	UMB10N	IMB10A	DTA123J×2	2.2	47	50	0.1
		EMB11	UMB11N	IMB11A	DTA114E×2	10	10		0.05
		EMB2	UMB2N	IMB2A	DTA144E×2	47	47		0.03
		EMB3	UMB3N	IMB3A	DTA143T×2	4.7	—		0.1
		EMB4	UMB4N		DTA114T×2	10	—		0.1
		EMH10	UMH10N		DTC123J×2	2.2	47		0.1
NPN×2		EMH25	☆UMH25N		DTC143Z×2	4.7	47		0.1
		EMH11	UMH11N	IMH11A	DTC114E×2	10	10		0.05
		EMH9	UMH9N	IMH9A	DTC114Y×2	10	47		0.07
		EMH1	UMH1N	IMH1A	DTC124E×2	22	22		0.03
		EMH2	UMH2N	IMH2A	DTC144E×2	47	47		0.03
		EMH3	UMH3N	IMH3A	DTC143T×2	4.7	—		0.1
		EMH4	UMH4N	IMH4A	DTC114T×2	10	—	0.1	
		PNP+NPN Complimentary			New UMD25N		DTA123J DTC123J	2.2 2.2	47 47
EMD22	UMD22N				DTA143Z DTC143Z	4.7 4.7	47 47	0.1	
EMD3	UMD3N			IMD3A	DTA114E DTC114E	10 10	10 10	0.05	
EMD9	UMD9N			IMD9A	DTA114Y DTC114Y	10 10	47 47	0.07	
EMD2	UMD2N			IMD2A	DTA124E DTC124E	22 22	22 22	0.03	
EMD12	UMD12N				DTA144E DTC144E	47 47	47 47	0.03	
	EMD6		UMD6N	IMD6A	DTA143T DTC143T	4.7 4.7	— —	0.1	
	PNP+NPN Different type		EMD38			DTA113Z DTC114Y	1 10	10 47	0.1 0.07
EMD5		UMD5N		DTA143X DTC144E	4.7 47	10 47	0.1 0.03		
EMD4		UMD4N		DTA114Y DTC144E	10 47	47 47	0.1 0.03		

Notes1 : For Pin location, please see the technical specifications.
Notes2 : PNP (-) symbol omitted.
Notes3 : Package is JEDEC code. () :ROHM Packages , [] :JEITA code

☆ : Under Development

Complex Digital Transistors

100mA Complex Digital Transistors(Including Automotive use)											
Package	Configuration	Product No.			Equivalent Element Transistors	R1 (kΩ)	R2 (kΩ)	V _{CC} (V _{CE0}) (V)	I ₀ (I _c) (A)	Automotive Grade AEC-Q101	
		Part No.	Grade Code								Taping Code
			General	Automotive							
	PNP×2	EMB10	FHA	T2R	DTA123J×2	2.2	47	50	0.1	YES	
		EMB11	FHA	T2R	DTA114E×2	10	10	50	0.05	YES	
		EMB2	FHA	T2R	DTA144E×2	47	47	50	0.03	YES	
		EMB3	FHA	T2R	DTA143T×2	4.7	—	50	0.1	YES	
		EMB4	FHA	T2R	DTA114T×2	10	—	50	0.1	YES	
	NPN×2	EMH10	FHA	T2R	DTC123J×2	2.2	47	50	0.1	YES	
		EMH25	FHA	T2R	DTC143Z×2	4.7	47	50	0.1	YES	
		EMH11	FHA	T2R	DTC114E×2	10	10	50	0.05	YES	
		EMH9	FHA	T2R	DTC114Y×2	10	47	50	0.07	YES	
		EMH1	FHA	T2R	DTC124E×2	22	22	50	0.03	YES	
		EMH2	FHA	T2R	DTC144E×2	47	47	50	0.03	YES	
		EMH3	FHA	T2R	DTC143T×2	4.7	—	50	0.1	YES	
		EMH4	FHA	T2R	DTC114T×2	10	—	50	0.1	YES	
	PNP+NPN Complimentary	EMD22	*	FHA	T2R	DTA143Z DTC143Z	4.7 4.7	47 47	50	0.1	YES
		EMD3	FHA	T2R	DTA114E DTC114E	10 10	10 10	50	0.05	YES	
		EMD9	FHA	T2R	DTA114Y DTC114Y	10 10	47 47	50	0.07	YES	
		EMD2	FHA	T2R	DTA124E DTC124E	22 22	22 22	50	0.03	YES	
		EMD12	FHA	T2R	DTA144E DTC144E	47 47	47 47	50	0.03	YES	
		EMD6	FHA	T2R	DTA143T DTC143T	4.7 4.7	—	50	0.1	YES	
	PNP+NPN Different type	EMD38	—	—	T2R	DTA113Z DTC114Y	1 10	10 47	50	0.1 0.07	—
		EMD5	—	—	T2R	DTA143X DTC144E	4.7 47	10 47	50	0.1 0.03	—
EMD4		—	—	T2R	DTA114Y DTC144E	10 47	47 47	50	0.1 0.03	—	
	PNP×2	UMB10N	FHA	TN	DTA123J×2	2.2	47	50	0.1	YES	
		UMB11N	FHA	TN	DTA114E×2	10	10	50	0.05	YES	
		UMB2N	FHA	TN	DTA144E×2	47	47	50	0.03	YES	
		UMB3N	FHA	TN	DTA143T×2	4.7	—	50	0.1	YES	
		UMB4N	FHA	TN	DTA114T×2	10	—	50	0.1	YES	
	NPN×2	UMH10N	FHA	TN	DTC123J×2	2.2	47	50	0.1	YES	
		☆UMH25N	FHA	TN	DTC143Z×2	4.7	47	50	0.1	YES	
		UMH11N	FHA	TN	DTC114E×2	10	10	50	0.05	YES	
		UMH9N	FHA	TN	DTC114Y×2	10	47	50	0.07	YES	
		UMH1N	FHA	TN	DTC124E×2	22	22	50	0.03	YES	
		UMH2N	FHA	TN	DTC144E×2	47	47	50	0.03	YES	
		UMH3N	FHA	TN	DTC143T×2	4.7	—	50	0.1	YES	
		UMH4N	FHA	TN	DTC114T×2	10	—	50	0.1	YES	
	PNP+NPN Complimentary	New UMD25N	*	—	TR	DTA123J DTC123J	2.2 2.2	47 47	50	0.1	—
		UMD22N	FHA	TR	DTA143Z DTC143Z	4.7 4.7	47 47	50	0.1	YES	
		UMD3N	FHA	TR	DTA114E DTC114E	10 10	10 10	50	0.05	YES	
		UMD9N	FHA	TR	DTA114Y DTC114Y	10 10	47 47	50	0.07	YES	
		UMD2N	FHA	TR	DTA124E DTC124E	22 22	22 22	50	0.03	YES	
		UMD12N	FHA	TR	DTA144E DTC144E	47 47	47 47	50	0.03	YES	
		UMD6N	FHA	TR	DTA143T DTC143T	4.7 4.7	—	50	0.1	YES	
	PNP+NPN Different type	UMD5N	—	—	TR	DTA143X DTC144E	4.7 47	10 47	50	0.1 0.03	—
UMD4N		—	—	TR	DTA114Y DTC144E	10 47	47 47	50	0.1 0.03	—	
	PNP×2	IMB10A	—	T110	DTA123J×2	2.2	47	50	0.1	—	
		IMB11A	—	T110	DTA114E×2	10	10	50	0.05	—	
		IMB2A	—	T110	DTA144E×2	47	47	50	0.03	—	
		IMB3A	—	T110	DTA143T×2	4.7	—	50	0.1	—	
		IMH11A	FRA	T110	DTC114E×2	10	10	50	0.05	YES*1	
	NPN×2	IMH9A	FRA	T110	DTC114Y×2	10	47	50	0.07	YES*1	
		IMH1A	—	T110	DTC124E×2	22	22	50	0.03	—	
		IMH2A	—	T110	DTC144E×2	47	47	50	0.03	—	
		IMH3A	—	T110	DTC143T×2	4.7	—	50	0.1	—	
		IMH4A	—	T110	DTC114T×2	10	—	50	0.1	—	
		IMD3A	FRA	T108	DTA114E DTC114E	10 10	10 10	50	0.05	YES*1	
	PNP+NPN Complimentary	IMD9A	FRA	T108	DTA114Y DTC114Y	10 10	47 47	50	0.07	YES*1	
		IMD2A	—	T108	DTA124E DTC124E	22 22	22 22	50	0.03	—	
		IMD6A	—	T108	DTA143T DTC143T	4.7 4.7	—	50	0.1	—	

Notes1 : * : General part No. have no grade code.
 Notes2 : For Pin location, please see the technical specifications.
 Notes3 : *1 Not recommended for a new design.
 Notes4 : PNP (—) symbol omitted.
 Notes5 : Package is JEDEC code. () :ROHM Packages , [] :JEITA code

☆ : Under Development

Quick Reference for 100mA Complex Digital Transistors(For Consumer only) 1							
Configuration	Equivalent Circuit Diagram (TOP View)	SOT-563 (EMT6) [SC-107C] 1616 size	Equivalent Element Transistors	R1 (kΩ)	R2 (kΩ)	V _{CC} (V _{CE0}) (V)	I _o (I _c) (A)
		Part No.					
PNP×2		EMB60	DTA023J×2	2.2	47	50	0.1
		EMB75	DTA043Z×2	4.7	47		0.1
		EMB61	DTA014E×2	10	10		0.05
		EMB59	DTA014Y×2	10	47		0.07
		EMB51	DTA024E×2	22	22		0.03
		EMB52	DTA044E×2	47	47		0.03
	EMB53	DTA043T×2	4.7	—	0.1		
NPN×2		EMH60	DTC023J×2	2.2	47		0.1
		EMH75	DTC043Z×2	4.7	47		0.1
		EMH61	DTC014E×2	10	10		0.05
		EMH59	DTC014Y×2	10	47		0.07
		EMH51	DTC024E×2	22	22		0.03
		EMH52	DTC044E×2	47	47		0.03
	EMH53	DTC043T×2	4.7	—	0.1		
PNP+NPN Complimentary		EMD72	DTA043Z DTC043Z	4.7 4.7	47 47	0.1	
		EMD53	DTA014E DTC014E	10 10	10 10	0.05	
		EMD59	DTA014Y DTC014Y	10 10	47 47	0.07	
		EMD52	DTA024E DTC024E	22 22	22 22	0.03	
		EMD62	DTA044E DTC044E	47 47	47 47	0.03	

Notes1 : For Pin location, please see the technical specifications.
 Notes2 : PNP (-) symbol omitted.
 Notes3 : Package is JEDEC code. () :ROHM Packages , [] :JEITA code

100mA Complex Digital Transistors(For Consumer only) 1										
Package	Configuration	Product No.			Equivalent Element Transistors	R1 (kΩ)	R2 (kΩ)	V _{CC} (V _{CE0}) (V)	I _o (I _c) (A)	Automotive Grade AEC-Q101
		Part No.	Grade Code							
			General	Automotive						
	PNP×2	EMB60	—	T2R	DTA023J×2	2.2	47	50	0.1	—
		EMB75	—	T2R	DTA043Z×2	4.7	47	50	0.1	—
		EMB61	—	T2R	DTA014E×2	10	10	50	0.05	—
		EMB59	—	T2R	DTA014Y×2	10	47	50	0.07	—
		EMB51	—	T2R	DTA024E×2	22	22	50	0.03	—
		EMB52	—	T2R	DTA044E×2	47	47	50	0.03	—
	NPN×2	EMB53	—	T2R	DTA043T×2	4.7	—	50	0.1	—
		EMH60	—	T2R	DTC023J×2	2.2	47	50	0.1	—
		EMH75	—	T2R	DTC043Z×2	4.7	47	50	0.1	—
		EMH61	—	T2R	DTC014E×2	10	10	50	0.05	—
		EMH59	—	T2R	DTC014Y×2	10	47	50	0.07	—
		EMH51	—	T2R	DTC024E×2	22	22	50	0.03	—
	PNP+NPN Complimentary	EMH52	—	T2R	DTC044E×2	47	47	50	0.03	—
		EMH53	—	T2R	DTC043T×2	4.7	—	50	0.1	—
		EMD72	—	T2R	DTA043Z DTC043Z	4.7 4.7	47 47	50	0.1	—
		EMD53	—	T2R	DTA014E DTC014E	10 10	10 10	50	0.05	—
		EMD59	—	T2R	DTA014Y DTC014Y	10 10	47 47	50	0.07	—
		EMD52	—	T2R	DTA024E DTC024E	22 22	22 22	50	0.03	—
EMD62	—	T2R	DTA044E DTC044E	47 47	47 47	50	0.03	—		

Notes1 : * : General part No. have no grade code.
 Notes2 : For Pin location, please see the technical specifications.
 Notes3 : PNP (-) symbol omitted.
 Notes4 : Package is JEDEC code. () :ROHM Packages , [] :JEITA code

Complex Digital Transistors

Quick Reference for 100mA Complex Digital Transistors(For Consumer only) 2									
Configuration	Equivalent Circuit Diagram (TOP View)	SOT-553 (EMT5) [SC-107BB] 1616 size	SOT-353 (UMT5) [SC-88A] 2021 size	SOT-25 (SMT5) [SC-74A] 2928 size	Equivalent Element Transistors	R1 (kΩ)	R2 (kΩ)	V _{CC} (V _{CE0}) (V)	I _o (I _c) (A)
		Part No.							
PNP×2		EMA5	UMA5N	FMA5A	DTA123J×2	2.2	47	50	0.1
			UMA9N	FMA9A	DTA114E×2	10	10		0.05
			UMA1N	FMA1A	DTA124E×2	22	22		0.03
		EMA2	UMA2N	FMA2A	DTA144E×2	47	47		0.03
		EMA3	UMA3N	FMA3A	DTA143T×2	4.7	—		0.1
		EMA4	UMA4N	FMA4A	DTA114T×2	10	—		0.1
NPN×2		EMG11	UMG11N		DTC123J×2	2.2	47	50	0.1
		EMG8	UMG8N		DTC143Z×2	4.7	47		0.1
		EMG9	UMG9N	FMG9A	DTC114E×2	10	10		0.05
		EMG5	UMG5N		DTC114Y×2	10	47		0.07
		EMG1	UMG1N	FMG1A	DTC124E×2	22	22		0.03
		EMG2	UMG2N	FMG2A	DTC144E×2	47	47		0.03
		EMG3	UMG3N	FMG3A	DTC143T×2	4.7	—		0.1
		EMG4	UMG4N	FMG4A	DTC114T×2	10	—		0.1
	EMG6	UMG6N	FMG6A	DTC144T×2	47	—	0.1		

Notes1 : For Pin location, please see the technical specifications.
 Notes2 : PNP (—) symbol omitted.
 Notes3 : Package is JEDEC code. () :ROHM Packages , [] :JEITA code

100mA Complex Digital Transistors(For Consumer only) 2										
Package	Configuration	Product No.			Equivalent Element Transistors	R1 (kΩ)	R2 (kΩ)	V _{CC} (V _{CE0}) (V)	I _o (I _c) (A)	Automotive Grade AEC-Q101
		Part No.	Grade Code							
			General	Automotive						
SOT-553 (EMT5) [SC-107BB] 1616 size	PNP×2	EMA5	—	T2R	DTA123J×2	2.2	47	50	0.1	—
		EMA2	—	T2R	DTA144E×2	47	47	50	0.03	—
		EMA3	—	T2R	DTA143T×2	4.7	—	50	0.1	—
		EMA4	—	T2R	DTA114T×2	10	—	50	0.1	—
	NPN×2	EMG11	—	T2R	DTC123J×2	2.2	47	50	0.1	—
		EMG8	—	T2R	DTC143Z×2	4.7	47	50	0.1	—
		EMG9	—	T2R	DTC114E×2	10	10	50	0.05	—
		EMG5	—	T2R	DTC114Y×2	10	47	50	0.07	—
		EMG1	—	T2R	DTC124E×2	22	22	50	0.03	—
		EMG2	—	T2R	DTC144E×2	47	47	50	0.03	—
		EMG3	—	T2R	DTC143T×2	4.7	—	50	0.1	—
		EMG4	—	T2R	DTC114T×2	10	—	50	0.1	—
	EMG6	—	T2R	DTC144T×2	47	—	50	0.1	—	
SOT-353 (UMT5) [SC-88A] 2021 size	PNP×2	UMA5N	—	TR	DTA123J×2	2.2	47	50	0.1	—
		UMA9N	—	TR	DTA114E×2	10	10	50	0.05	—
		UMA1N	—	TR	DTA124E×2	22	22	50	0.03	—
		UMA2N	—	TR	DTA144E×2	47	47	50	0.03	—
		UMA3N	—	TR	DTA143T×2	4.7	—	50	0.1	—
		UMA4N	—	TR	DTA114T×2	10	—	50	0.1	—
	NPN×2	UMG11N	—	TR	DTC123J×2	2.2	47	50	0.1	—
		UMG8N	—	TR	DTC143Z×2	4.7	47	50	0.1	—
		UMG9N	—	TR	DTC114E×2	10	10	50	0.05	—
		UMG5N	—	TR	DTC114Y×2	10	47	50	0.07	—
		UMG1N	—	TR	DTC124E×2	22	22	50	0.03	—
		UMG2N	—	TR	DTC144E×2	47	47	50	0.03	—
		UMG3N	—	TR	DTC143T×2	4.7	—	50	0.1	—
		UMG4N	—	TR	DTC114T×2	10	—	50	0.1	—
	UMG6N	—	TR	DTC144T×2	47	—	50	0.1	—	
SOT-25 (SMT5) [SC-74A] 2928 size	PNP×2	FMA5A	—	T148	DTA123J×2	2.2	47	50	0.1	—
		FMA9A	—	T148	DTA114E×2	10	10	50	0.05	—
		FMA1A	—	T148	DTA124E×2	22	22	50	0.03	—
		FMA2A	—	T148	DTA144E×2	47	47	50	0.03	—
		FMA3A	—	T148	DTA143T×2	4.7	—	50	0.1	—
		FMA4A	—	T148	DTA114T×2	10	—	50	0.1	—
	NPN×2	FMG9A	—	T148	DTC114E×2	10	10	50	0.05	—
		FMG1A	—	T148	DTC124E×2	22	22	50	0.03	—
		FMG2A	—	T148	DTC144E×2	47	47	50	0.03	—
		FMG3A	—	T148	DTC143T×2	4.7	—	50	0.1	—
		FMG4A	—	T148	DTC114T×2	10	—	50	0.1	—
		FMG6A	—	T148	DTC144T×2	47	—	50	0.1	—

Notes1 : * : General part No. have no grade code.
 Notes2 : For Pin location, please see the technical specifications.
 Notes3 : PNP (—) symbol omitted.
 Notes4 : Package is JEDEC code. () :ROHM Packages , [] :JEITA code

Quick Reference for Complex Digital Transistors(For Power Management, Muting and Drivers)									
Configuration	Equivalent Circuit Diagram (TOP View)	SOT-563 (EMT6) [SC-107C] 1616 size	SOT-363 (UMT6) [SC-88] 2021 size	SOT-457 (SMT6) [SC-74] 2928 size	SOT-363T (TUMT6) [SC-113DA] 2021 size	SOT-457T (TSMT6) [SC-95] 2928 size	Equivalent Element Transistors	R1 (kΩ)	R2 (kΩ)
Part No.									
PNP+NPN Power Management		EMD29					DTB513Z DTC114E	1 10	10 10
				IMD10A			—50V/—0.5A DTC114T	0.1 10	10 —
				IMD16A			—50V/—0.5A DTC115T	2.2 100	22 —
NPN×2 Muting				IMH23	US6H23		DTC643T×2	4.7	—
				IMH21			DTC614T×2	10	—
			UMH33N				DTC923TUB×2	2.2	—
			UMH32N				DTC943TUB×2	4.7	—
NPN×2 Driver						QSH29	60±10V/500mA×2	—	10

Notes1 : No.1 pin is located on the upper right of equivalent circuit diagram for SOT-563(EMT6) and SOT-363(UMT6) packages. No.1 pin is located on the lower right of equivalent circuit diagram for SOT-457(SMT6) packages.
Notes2 : PNP (—) symbol omitted.
Notes3 : Package is JEDEC code. () :ROHM Packages , [] :JEITA code

Complex Digital Transistors(For Power Management, Muting and Drivers)											
Package	Configuration	Product No.			Equivalent Element Transistors	R1 (kΩ)	R2 (kΩ)	V _{CC} (V _{CEO}) (V)	I _O (I _C) (A)	Automotive Grade AEC-Q101	
		Part No.	Grade Code								Taping Code
			General	Automotive							
 SOT-563 (EMT6) [SC-107C] 1616 size	PNP+NPN Power Management	EMD29	*	—	T2R	DTB513Z DTC114E	1 10	10 10	12	0.5	—
 SOT-363 (UMT6) [SC-88] 2021 size	NPN×2 Muting	UMH33N	*	—	TN	DTC923TUB×2	2.2	—	40 (V _{EBO})	0.4	—
		UMH32N	*	—	TN	DTC943TUB×2	4.7	—	40 (V _{EBO})	0.4	—
		UMH37N	*	—	TN	DTC914TUB×2	10	—	40 (V _{EBO})	0.4	—
 SOT-457 (SMT6) [SC-74] 2928 size	PNP+NPN Power Management	IMD10A	*	—	T108	Exclusive chip DTC114T	0.1 10	10 —	50	0.5	—
		IMD16A	*	—	T108	Exclusivechip DTC115T	2.2 100	22 —	50	0.5	—
	NPN×2 Muting	IMH23	*	—	T110	DTC643T×2	4.7	—	20	0.6	—
		IMH21	*	—	T110	DTC614T×2	10	—	20	0.6	—
 SOT-363T (TUMT6) [SC-113DA] 2021 size	NPN×2 Muting	US6H23	*	—	TR	DTC643T×2	4.7	—	20	0.6	—
 SOT-457T (TSMT6) [SC-95] 2928 size	NPN×2 Driver	QSH29	*	—	TR	Exclusive chip×2	—	10	60±10	0.5	—

Notes1 : * : General part No. have no grade code.
Notes2 : No.1 pin is located on the upper right of equivalent circuit diagram for SOT-563(EMT6) and SOT-363(UMT6) packages. No.1 pin is located on the lower right of equivalent circuit diagram for SOT-457(SMT6) packages.
Notes3 : PNP (—) symbol omitted.
Notes4 : Package is JEDEC code. () :ROHM Packages , [] :JEITA code

IC Transistor Array

* The following products are belonging to ICs. (Refer P.A20) Please ask IC product group for inquiry.

Transistor Array											
Part No.	Number of Bit	Output Withstand Voltage(V)	Output Saturation Voltage(V)	Output Current (mA)	Input Resistance (kΩ)	Input/Output Relation	Input Active Level	Output Current Relation	Circuit Construction	Features	Package
BA12003BF	7	60	1.46*	500	2.7	Inverting type	H	Sink	Darlington	Built-in surge absorbing diode	SOP16
BA12004BF	7	60	1.46*	500	10.5	Inverting type	H	Sink	Darlington	Built-in surge absorbing diode	SOP16

Note: * Output Current=350mA

Packages

● Dimensions (Unit : mm)

DFN0604-3 (VML0604) 	DFN0806-3 (VML0806) 	DFN1006-3 (VML1006) [SC-101] 	SOT-723 (VMT3) [SC-105AA] 	(VMT6) [SC-105B] 	SOT-416FL (EMT3F) [SC-89] 	SOT-416 (EMT3) [SC-75A] 	SOT-553 (EMT5) [SC-107BB]
SOT-563 (EMT6) [SC-107C] 	SOT-323FL (UMT3F) [SC-85] 	SOT-323 (UMT3) [SC-70] 	SOT-353 (UMT5) [SC-88A] 	SOT-363 (UMT6) [SC-88] 			
SOT-23 (SST3) 	SOT-346 (SMT3) [SC-59] 	SOT-25 (SMT5) [SC-74A] 	SOT-457 (SMT6) [SC-74] 	(TSST8) 			
SOT-323T (TUMT3) [SC-113A] 	SOT-353T (TUMT5) [SC-113CA] 	SOT-363T (TUMT6) [SC-113DA] 	SOT-563T (WEMT6) [SC-120] 	SOT-346T (TSMT3) [SC-96] 	SOT-25T (TSMT5) 		
SOT-457T (TSMT6) [SC-95] 	(TSMT8) 	DFN2020-3S (HUML2020L3) 	DFN2020-8S (HUML2020L8 Single) 	DFN2020-8D (HUML2020L8 Dual) 			
(HSMT8) 	(HSMT8AG) 	(HSML3030L10) 	SOT-89 (MPT3) [SC-62] 				
(SOP8) 	(HSOP8 Single) 						

Notes1 : Package is JEDEC code. () :ROHM Packages , [] :JEITA code
 Notes2 : For details of dimensions, please refer to the technical specifications.

<p>(HSOP8 Asymmetry Dual)</p>	<p>(HSOP8 Symmetry Dual)</p>	<p>(HSOP8 Drain Common Dual)</p>	
<p>SOT-428 (CPT3 DPAK) [SC-63]</p>	<p>TO-252 *1 (DPAK)</p>	<p>TO-252 *2 (DPAK)</p>	<p>TO-263S (LPTS D2-PAK) [SC-83]</p>
<p>TO-263AB (LPTL)</p>	<p>TO-220AB</p>	<p>TO-220FM</p>	<p>TO-3PF</p>
<p>TO-247</p>	<p>TO-247N</p>		

Notes1 : *1 Taping code : TL, *2 Taping code : TL1
 Notes2 : Package is JEDEC code. () : ROHM Packages, [] : JEITA code
 Notes3 : For details of dimensions, please refer to the technical specifications.

Part No. Explanation

• MOSFET Part No. Explanation

<Single-Chip type>

Example: **R T Q 0 3 5 P 0 2 T R**

ROHM

Drive Voltage

Type of MOSFET	Drive Voltage(V)				
	0.9/1.2/1.5/1.8	2.5	4	4.5	10
Low loss type	—	—	C	—	C
General use type	Z,U,Y	T	D,R,S,X	—	—
High ESD Resistance type	—	J	H	—	—
Stripe	A	—	—	—	—

Package

Symbol	Package
M	SOT-723
U	SOT-323
F	SOT-323T
L	SOT-363T
C	SOT-23
K	SOT-346
R	SOT-346T
Q	SOT-457T
P	SOT-89
H	(SOP8)
S	(SOP8)
D	SOT-428
J	TO-263AB
X	TO-220FM

V_{DS}

Symbol	V _{DS} (V)
01	12
02	20
03	30
04	40
05	45
06	60
10	100
19	190
20	200
25	250

Tape Code

Polarity

N	Nch
P	Pch

I_D(Unit: 100mA)
ex.)
035=3,500mA(3.5A)

<Single-Chip type>

Example: **R T 1 A 0 4 0 Z P T L**

ROHM

Package

Symbol	Package
V3	DFN0604-3
V1	DFN0806-3
V2	DFN1006-3
E1	SOT-416FL
U1	SOT-323FL
W1	SOT-563T
T1	(TSST8)
F5	SOT-323T
F6	SOT-363T
Q5	SOT-346T
Q6	SOT-457T
Q1	(TSMT8)
Q7	(TSMT8)
F4	DFN2020-8S
F6	SOT-363T
Q3	(HSMT8)
S3	(SOP8)
S1	(HSOP8)
D1	SOT-428
D3	TO-252
X1	TO-220AB
J1	TO-263S
Z2	TO-247N

V_{DS}

Symbol	V _{DS} (V)
A	12
C	20
E	30
G	40
H	45
J	50
L	60
P	100
S	190
T	200
U	250

I_D(A)
ex.)
040=4A
013=1.3A

Drive Voltage

Symbol	Process	Pol.	Drive Voltage	Comment
SN	Gen.1	Nch	2.5V/4.0V	—
UN	Gen.1	Nch	1.2V/1.5V	—
YN	Gen.1	Nch	0.9V	—
MN	Gen.3	Nch	4.5V	High Performance
BN	Gen.4	Nch	4.5V	—
AD	Gen.4	Nch	4.5V	Built-in ESD Protection
GN	Gen.4	Nch	4.5V	High Performance
AJ	Gen.5	Nch	2.5V	—
SP	Gen.1	Pch	2.5V/4.0V	—
RP	Gen.2	Pch	4.0V	—
ZP	Gen.2	Pch	1.2V/1.5V	—
AP	Gen.4	Pch	1.5V	—
BC	Gen.5	Pch	2.5V	—
AT	Gen.4	Pch	4.5V	—
AA	Gen.1	Nch	10V	For Automotive
AM	Gen.1	Nch	10V	Built-in ESD Protection
BD	Gen.3	Nch	6.0V	—
BE	Gen.3	Nch	10V	—
CN	Gen.1	Nch	10V	—

Tape Code

<Dual-Chip type>

Example: **S H 8 M 3** **T B**

Package

Symbol	Package
VT6	(VMT6)
EM6	SOT-563
UM6	SOT-363
ES6	SOT-563T
US5	SOT-353T
US6	SOT-363T
TT8	(TSST8)
QS5	SOT-25T
QS6	SOT-457T
QH6	SOT-457T
QS8	(TSMT8)
QH8	(TSMT8)
UT6	DFN2020-8D
HS8	(HSML3030L10)
SH8	(SOP8)
SP8	(SOP8)
HP8	(HSOP8)

Polarity

K	Nch+Nch
J	Pch+Pch
M	Nch+Pch
U	MOS+SBD
S	Nch+Nch+SBD

Serial No.(include alphabets)
Note) "N" is put to UMT5 & UMT6 packages

<Single-Chip type>

Example: **R 6 0 2 0 E N X** **C 7**

ROHM

V_{DS}(V)
60=600V

I_D(A)
20=20A

Polarity
N=Nch

Package

Symbol	Package
D3	TO-252
J	TO-263
X	TO-220FM
X1	TO-220AB
Z	TO-3PF
Z1	TO-247
Z2	TO-247N

A=No G-S Protection Diode
C=With G-S Protection Diode
E=Low Noise
J, M=Fast Recovery Body Diode
K=Fast Switching

Tape Code

<Automotive type>

Example: **A G 0 0 9 D G Q 3 T B**

ROHM
AEC-Q101 qualified

Serial No.

Drive Voltage

Symbol	Process	Pol.	Drive Voltage
D	Gen.4	N	4.5V

V_{DS}

Symbol	V _{DS} (V)
G	40

Package

Symbol	Package
Q3	HSMT8AG

Tape Code

• Bipolar Transistor Part No. Explanation

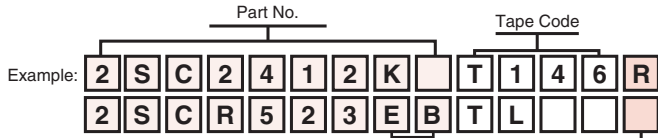

• Package

Code	Package
M	SOT-723
EB	SOT-416FL
E	SOT-416
UB	SOT-323FL
U	SOT-323
U3	SOT-323
K	SOT-346
C	SOT-23
R	SOT-346T
F3	DFN2020-3S
P	SOT-89
P5	SOT-89
D	SOT-428
D3	TO-252

• hFE Ranking Code

Code	hFE Range
N	56 to 120
P	82 to 180
Q	120 to 270
R	180 to 390
S	270 to 560
U	560 to 1200
V	820 to 1800
W	1200 to 2700

• Digital Transistor Part No. Explanation

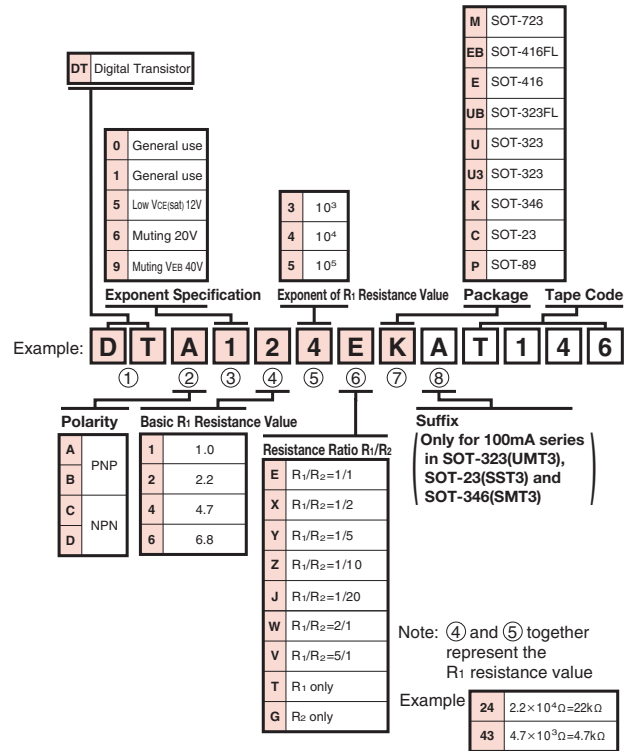

• Packaging type

Package	Code	Packaging Style	Direction	Basic Ordering Unit (pcs)
DFN0604-3(VML0604)	T2L,T2CL	Embossed tape	Terminal No.1 on opposite side from sprocket hole side	8,000
DFN0806-3(VML0806)	T2L,T2CL	Embossed tape	Terminal No.1 on opposite side from sprocket hole side	8,000
DFN1006-3(VML1006)	T2L,T2CL	Embossed tape	Terminal No.1 on opposite side from sprocket hole side	8,000
SOT-723(VMT3)	T2L,T2CL	Embossed tape	One terminal on sprocket hole side	8,000
(VMT6)	T2R,T2CR	Embossed tape	Terminal No.1 on sprocket hole side	8,000
SOT-416FL(EMT3F)	TL,TCL	Embossed tape	One terminal on sprocket hole side	3,000
SOT-416(EMT3)	TL,TCL	Embossed tape	One terminal on sprocket hole side	3,000
SOT-553(EMT5)	T2R,T2CR	Embossed tape	Three terminals on sprocket hole side	8,000
SOT-563(EMT6)	T2R,T2CR	Embossed tape	Terminal No.1 on sprocket hole side	8,000
SOT-323FL(UMT3F)	TL,TCL	Embossed tape	One terminal on sprocket hole side	3,000
SOT-323(UMT3)	T106,T306	Embossed tape	One terminal on sprocket hole side	3,000
SOT-353(UMT5)	TR,TCR	Embossed tape	Three terminals on sprocket hole side	3,000
SOT-363(UMT6)	TR,TCR	Embossed tape	Terminal No.1 on sprocket hole side	3,000
	TN,TCN	Embossed tape	Non-direction	3,000
SOT-563T(WEMT6)	T2R,T2CR	Embossed tape	Terminal No.1 on sprocket hole side	8,000
SOT-323T(TUMT3)	TL,TCL	Embossed tape	One terminal on sprocket hole side	3,000
SOT-353T(TUMT5)	TR,TCR	Embossed tape	Terminal No.1 on sprocket hole side	3,000
SOT-363T(TUMT6)	TR,TCR	Embossed tape	Terminal No.1 on sprocket hole side	3,000
SOT-23(SST3)	T116,T316	Embossed tape	One terminal on sprocket hole side	3,000
SOT-346(SMT3)	T146	Embossed tape	One terminal on sprocket hole side	3,000
SOT-25(SMT5)	T148	Embossed tape	Three terminals on sprocket hole side	3,000
SOT-457(SMT6)	T108	Embossed tape	Terminal No.1 on opposite side from sprocket hole side	3,000
	T110	Embossed tape	Non-direction	3,000
(TSST8)	TR,TCR	Embossed tape	Terminal No.1 on sprocket hole side	3,000
SOT-346T(TSMT3)	TL,TCL	Embossed tape	One terminal on sprocket hole side	3,000
SOT-25T(TSMT5)	TR,TCR	Embossed tape	Terminal No.1 on sprocket hole side	3,000
SOT-457T(TSMT6)	TR,TCR	Embossed tape	Terminal No.1 on sprocket hole side	3,000
(TSMT8)	TR,TCR	Embossed tape	Terminal No.1 on sprocket hole side	3,000
DFN2020-3S(HUML2020L3)	TR,TCR	Embossed tape	Terminal No.1 on opposite side from sprocket hole side	3,000
DFN2020-8(HUML2020L8)	TR,TCR	Embossed tape	Terminal No.1 on sprocket hole side	3,000
(HSMT8)	TB	Embossed tape	Terminal No.1 on sprocket hole side	3,000
(HSMT8AG)	TB	Embossed tape	Terminal No.1 on sprocket hole side	3,000
(HSML3030L10)	TB	Embossed tape	Terminal No.1 on sprocket hole side	3,000
(SOP8)	TB	Embossed tape	Terminal No.1 on sprocket hole side	2,500
SOT-89(MPT3)	T100	Embossed tape	Three terminals on sprocket hole side	1,000
(HSOP8)	TB	Embossed tape	Three terminals on sprocket hole side	2,500
SOT-428(CPT3)	TL	Embossed tape	Fin on sprocket hole side	2,500
TO-252	TL,TL1	Embossed tape	Fin on sprocket hole side	2,500
TO-263(LPT)	TL	Embossed tape	Fin on sprocket hole side	1,000
	TLL	Embossed tape	Fin on sprocket hole side	1,000
TO-220FM	—	Bulk	—	500
	C7	Tube	—	1,000
TO-220AB	C10	Tube	—	1,000
TO-3PF	C8	Tube	—	360
TO-247	C9	Tube	—	450
TO-247N	C11	Tube	—	450

Notes : Package is JEDEC code. () :ROHM Packages



Discrete Devices

Diodes

CONTENTS

■ Schottky Barrier Diodes	P. C60
Small Signal type Schottky Barrier Diodes	P. C60
Middle Power Schottky Barrier Diodes	P. C65
Power Schottky Barrier Diodes	P. C68
■ Fast Recovery Diodes	P. C71
Small Signal/Middle Power Fast Recovery Diodes	P. C71
Power Fast Recovery Diodes	P. C72
■ Rectifier Diodes	P. C75
■ Zener Diodes	P. C76
■ Zener Diodes as ESD Protection	P. C78
■ TVS	P. C80
■ Switching Diodes	P. C83
■ High Frequency Diodes	P. C85
■ Packages	P. C86
■ Product No. Explanation	P. C88









Schottky Barrier Diodes

Quick Reference for Small Signal type Schottky Barrier Diodes

V _R (V)	I _o (mA)	Package														
		0402 Size		0603 Size			1006 Size			1406 Size						
		DSN0402-2 (SMD0402)		DSN0603-2 (SMD0603)		SOD-962 (GMD2)		DSN1006-2 (SMD1006)		DFN1006-2 (VML2)		SOD-923 (VMN2)	SOD-923 (VMN2M)	SOD-723 (VMD2)		
20	500								RBE05AS20A	11						
	2,000							RAS MID RB061QS-20	4							
30	30										RB751CS-40	16	RB751CM-40	19	RB751G-40	32
	100	RAS MID RB522FS-30	1	RAS MID RB522ES-30 RAS MID RB531ES-30	2 3	RB520ZS-30 RB521ZS-30	6 7				RB520CS-30 RB521CS-30	17 18	RB520CM-30 RB521CM-30 RB530CM-30 RB531CM-30	20 21 22 23	RB520G-30 RB521G-30	30 31
	200								RB520AS-30 RB521AS-30	12 13						
40	30					RB751ZS-40	8									
	100					RB520ZS-40 RB521ZS-40	9 10						RB530CM-40 RB531CM-40 RB520CM-40 RB521CM-40	24 25 26 27	RB520G-40 RB521G-40	33 34
	200									RB520AS-40 RB521AS-40	14 15					
60	100															
	1,000							RAS MID RB161QS-40	5					RB530CM-60 RB520CM-60	28 29	

V _R (V)	I _o (mA)	Package													
		1608 Size		2512 Size		2514 Size		1212 Size		1616 Size		2120 Size			
		SOD-523 (EMD2)		SOD-323FL (UMD2)		(TUMD2M)		SOT-723 (VMD3)		SOT-416FL (EMD3F)		SOT-543 (EMD4)		SOT-323 (UMD3)	SOT-323FL (UMD3F)
20	500	RBE02SM20A	35	RB551VM-30 RBE05VM20A	54 55	RB411VAM-50	81								
	700			RBE07V20A	56								RB461F	136	
	1,000					RB162VAM-20 RB161VAM-20 RBE1VAM20A	82 83 84								
	2,000					RBE2VAM20A	85								
30	30	RB751SM-40	36	RB751VM-40	57										
	100	RB510SM-30	37	RB510VM-30	58					RB548WM	129	RB481Y	146		
		RB511SM-30	38	RB530VM-30	59					RB557WM	125	RB480Y	147		
		RB500SM-30	39	RB511VM-30	60					RB558WM	130				
		RB501SM-30	40	RB531VM-30	61										
	200	RB520SM-30	41	RB520VM-30	62										
		RB521SM-30	42	RB521VM-30	63										
		RB530SM-30	43	RB540VM-30	64										
		RB531SM-30	44	RB541VM-30	65										
	500			RB550VM-30	66	RSX051VAM30 RSX051VYM30	86 87								
700						RSX071VAM30 RSX071VYM30	88 89								
1,000					RB168VAM-30 RB168VYM-30	90 91									
					RB550VAM-30 RB550VYM-30	92 93									
					RSX101VAM30 RSX101VYM30	94 95									
					RSX201VAM30 RSX201VYM30	96 97									
	1,500														
40	30							RB715Z	117	RB706WM-40 RB715WM	131 118			RB706UM-40 RB715UM RB717UM	132 119 126
	100	RB510SM-40	45	RB510VM-40	67										
		RB511SM-40	46	RB530VM-40	68										
		RB530SM-40	47	RB531VM-40	69										
		RB531SM-40	48	RB500VM-40 RB501VM-40	70 71 72									RB450UM RB451UM	138 137
		RB540SM-40	49	RB540VM-40	73										
	200	RB541SM-40	50	RB541VM-40	74							RB481Y-40 RB480Y-40	148 149		
		RB520SM-40	51	RB520VM-40	75										
		RB521SM-40	52	RB521VM-40 RB550VM-40 RB551VM-40	76 77 78										
		500			RB560VM-40 RB561VM-40	79 80	RB400VAM-50 RB400VYM-50	98 99							
1,000					RB160VAM-40 RB160VYM-40 RB168VAM-40 RB168VYM-40	100 101 102 103									
60	200	RB521SM-60	53												
	1,000					RB160VAM-60 RB160VYM-60 RB168VAM-60 RB168VYM-60	104 105 106 107								
90	100											RB481Y-90 RB480Y-90	150 151		
	200					RB021VAM90	108								
100	700					RB578VAM100 RB578VYM100	109 110								
	1,000					RB168VAM100 RB168VYM100	111 112								
150	500					RB558VAM150 RB558VYM150	113 114								
	1,000					RB168VAM150 RB168VYM150	115 116								

©RAS MID : ROHM's proprietary new method that enables superior dimensional precision, making it possible to develop the ultra-compact products.
Package is JEDEC code. (): ROHM Packages

V _R (V)	I _o (mA)	Package											
		2120 Size			2924 Size		2928 Size				3028 Size		
													
SOT-343 (UMD4)	SOT-353T (TUMD5)	SOT-363 (UMD6)	SOT-23 (SSD3)	SOT-346 (SMD3)	SOT-25 (SMD5)	SOT-25T (TSMD5)	SOT-457 (SMD6)	(TSMD8)					
20	500					RB411D	141						
	1,000		RB496KA RBE1KA20A	154 155			RB491D	142		RB496EA	157		
	2,000									RBE2EA20A	158		
25	400					RB495D	122						
30	100			RB530XN RB531XN RB541XN	161 162 163								
	200	RB481K	152			BAT54HM BAT54SHM BAT54CHM BAT54AHM	139 133 120 127						
	1,000									RB552EA	159		
	1,400									RB550EA	160		
	2,000											RB061US-30	166
40	30			RB731XN	164		RB705D RB706D-40	123 135				RB731U	165
	100	RB480K	153				RB420D RB421D RB425D	143 144 124	RB471E	156			
	120					BAS40HM BAS40-04HM BAS40-05HM BAS40-06HM	140 134 121 128						
	500						RB400D	145					

Package is JEDEC code. (): ROHM Packages



Schottky Barrier Diodes

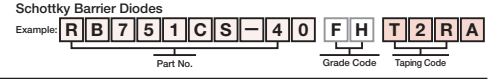

Quick Reference No.	Product No.				Absolute Maximum Ratings(Tc=25°C)				Electrical Characteristics(Tj=25°C)*2				Package	Equivalent Circuit Diagram	Automotive Grade AEC-Q101	
	Part No.	Grade Code		Taping Code	V _{RM} (V)	V _R (V)	I _O *1 (mA)	I _{FSM} (A)*2 60Hz.1~	V _F (V) Max.	I _F (mA)	I _R (μA) Max.	V _B (V)				
		General	Automotive													
1	RASMD RB522FS-30		—	T27R	30	30	100	0.5	0.37	10	7	10	DSN0402-2 (SMD0402)		—	
2	New RASMD RB522ES-30		—	T15R	30	30	100	0.5	0.37	10	7	10	DSN0603-2 (SMD0603)		—	
3	RASMD RB531ES-30		—	T15R	30	30	100	0.5	0.5	100	50	30	DSN1006-2 (SMD1006)		—	
4	New RASMD RB061QS-20		—	T18R	20	20	2,000	15	0.47	2,000	200	10	DSN1006-2 (SMD1006)		—	
5	New RASMD RB161QS-40		—	T18R	40	40	1,000	7	0.6	1,000	100	10	DSN1006-2 (SMD1006)		—	
6	RB520ZS-30	*	—	T2R	30	30	100	0.5	0.46	10	0.3	10	SOD-962 (GMD2)		—	
7	RB521ZS-30	*	—	T2R	30	30	100	0.5	0.37	10	7	10			—	
8	RB751ZS-40	*	—	T2R	40	40	30	0.2	0.37	1	0.5	30			—	
9	RB520ZS-40	*	—	T2R	40	40	100	0.5	0.48	10	2	40			—	
10	RB521ZS-40	*	—	T2R	40	40	100	0.5	0.41	10	25	40			—	
11	RBE05AS20A	*	—	T2R	30	20	500	1	0.53	0.5	0.15	20		DFN1006-2 (VML2)		—
12	RB520AS-30	*	—	T2R	30	30	200	1	0.6	200	1	10				—
13	RB521AS-30	*	—	T2R	30	30	200	1	0.5	200	30	10				—
14	RB520AS-40	*	—	T2R	40	40	200	1	0.55	100	10	40				—
15	RB521AS-40	*	—	T2R	45	40	200	1	0.45	100	90	40			—	
16	RB751CS-40	—	FH	T2RA	40	30	30	0.2	0.37	1	0.5	30	SOD-923 (VMN2)		YES	
17	RB520CS-30	—	FH	T2RA	—	30	100	0.5	0.45	10	0.5	10	SOD-923 (VMN2)		YES	
18	RB521CS-30	—	FH	T2RA	—	30	100	0.5	0.35	10	10	10	SOD-923 (VMN2)		YES	
19	RB751CM-40	—	—	T2R	40	30	30	0.2	0.37	1	0.5	30	SOD-923 (VMN2M)		—	
20	RB520CM-30	—	—	T2R	40	30	100	0.5	0.45	10	0.5	10			—	
21	RB521CM-30	—	—	T2R	—	30	100	0.5	0.35	10	10	10			—	
22	RB530CM-30	—	—	T2R	30	30	100	0.5	0.46	10	0.3	10			—	
23	RB531CM-30	—	—	T2R	30	30	100	0.5	0.37	10	7	10			—	
24	RB530CM-40	—	—	T2R	40	40	100	0.5	0.48	10	2	40			—	
25	RB531CM-40	—	—	T2R	40	40	100	0.5	0.41	10	25	40			—	
26	RB520CM-40	—	—	T2R	40	40	100	1	0.71	100	15	40			—	
27	RB521CM-40	—	—	T2R	40	40	100	1	0.61	100	100	40			—	
28	RB530CM-60	—	—	T2R	60	60	100	0.5	0.54	10	1	60			—	
29	RB520CM-60	—	—	T2R	60	60	100	1	0.44	10	3	60		—		
30	RB520G-30	FH	—	T2R	—	30	100	0.5	0.45	10	0.5	10	SOD-723 (VMD2)		YES	
31	RB521G-30	FH	—	T2R	—	30	100	0.5	0.35	10	10	10			YES	
32	RB751G-40	FH	—	T2R	40	30	30	0.2	0.37	1	0.5	30			YES	
33	RB520G-40	FH	—	T2R	40	40	100	1	0.71	100	15	40			YES	
34	RB521G-40	FH	—	T2R	40	40	100	1	0.61	100	100	40		YES		
35	RBE05SM20A	—	—	T2R	30	20	500	1	0.53	500	150	20	SOD-523 (EMD2)		—	
36	RB751SM-40	FH	—	T2R	40	30	30	0.2	0.37	1	0.5	30			YES	
37	RB510SM-30	FH	—	T2R	30	30	100	0.5	0.46	10	0.3	10			YES	
38	RB511SM-30	FH	—	T2R	30	30	100	0.5	0.37	10	7	10			YES	
39	RB500SM-30	FH	—	T2R	30	30	100	1	0.45	10	0.5	10			YES	
40	RB501SM-30	FH	—	T2R	30	30	100	1	0.35	10	10	10			YES	
41	RB520SM-30	FH	—	T2R	—	30	200	1	0.58	200	1	10			YES	
42	RB521SM-30	FH	—	T2R	—	30	200	1	0.47	200	30	10			YES	
43	RB530SM-30	FH	—	T2R	30	30	200	1	0.45	10	0.5	10			YES	
44	RB531SM-30	FH	—	T2R	30	30	200	1	0.35	10	10	10			YES	
45	RB510SM-40	FH	—	T2R	40	40	100	0.5	0.48	10	2	40		YES		
46	RB511SM-40	FH	—	T2R	40	40	100	0.5	0.41	10	25	40		YES		
47	RB530SM-40	FH	—	T2R	40	40	100	1	0.71	100	15	40		YES		
48	RB531SM-40	FH	—	T2R	40	40	100	1	0.61	100	100	40		YES		
49	RB540SM-40	FH	—	T2R	40	40	200	1	0.71	100	15	40		YES		
50	RB541SM-40	FH	—	T2R	40	40	200	1	0.61	100	100	40		YES		
51	RB520SM-40	FH	—	T2R	45	40	200	1	0.55	100	10	40		YES		
52	RB521SM-40	FH	—	T2R	45	40	200	1	0.45	100	90	40		YES		
53	RB521SM-60	FH	—	T2R	60	60	200	1	0.6	200	100	60		YES		
54	RB551VM-30	—	—	TE-17	30	20	500	2	0.36	100	100	20	SOD-323FL (UMD2)		—	
55	RBE05VM20A	—	—	TE-17	30	20	500	2	0.43	500	200	20			—	
56	RBE07V20A	—	—	TE-17	30	20	700	1	0.43	500	200	20			—	

©RASMD: ROHM's proprietary new method that enables superior dimensional precision, making it possible to develop the ultra-compact products.
 *: General part No. have no grade code.
 *1 : I_O : Average output current per chip. In case of 1, 2 or 3 chip diodes. I_O indicates average output current of 1, 2 or 3 chips.
 *2 : Value/Chip
 Package is JEDEC code. () : ROHM Packages

Schottky Barrier Diodes

Example: **R B 7 5 1 V M - 4 0 F H T E - 1 7**
 Part No. Grade Code Taping Code

Quick Reference No.	Product No.				Absolute Maximum Ratings(Tc=25°C)				Electrical Characteristics(Tj=25°C)*2				Package	Equivalent Circuit Diagram	Automotive Grade AEC-Q101
	Part No.	Grade Code		Taping Code	V _{RM} (V)	V _R (V)	I _o *1 (mA)	I _{FSM} (A)*2 60Hz.1~	V _F (V) Max.	I _R (mA)	I _R (μA) Max.	V _R (V)			
		General	Automotive												
57	RB751VM-40		FH	TE-17	40	30	30	0.2	0.37	1	0.5	30	SOD-323FL (UMD2)		YES
58	RB510VM-30		FH	TE-17	30	30	100	0.5	0.46	10	0.3	10			YES
59	RB530VM-30		FH	TE-17	30	30	100	0.5	0.45	10	0.5	10			YES
60	RB511VM-30		FH	TE-17	30	30	100	0.5	0.37	10	7	10			YES
61	RB531VM-30		FH	TE-17	30	30	100	1	0.35	10	10	10			YES
62	RB520VM-30		FH	TE-17	30	30	200	1	0.58	200	1	10			YES
63	RB521VM-30		FH	TE-17	30	30	200	1	0.47	200	30	10			YES
64	RB540VM-30		FH	TE-17	30	30	200	1	0.45	10	0.5	10			YES
65	RB541VM-30		FH	TE-17	30	30	200	1	0.35	10	30	10			YES
66	RB550VM-30		FH	TE-17	30	30	500	1	0.59	500	35	30			YES
67	RB510VM-40		FH	TE-17	40	40	100	0.1	0.48	10	2	40			YES
68	RB511VM-40		FH	TE-17	40	40	100	0.1	0.41	10	25	40			YES
69	RB530VM-40		FH	TE-17	40	40	100	1	0.71	100	15	40			YES
70	RB531VM-40		FH	TE-17	40	40	100	1	0.61	100	100	40			YES
71	RB500VM-40	*	FH	TE-17	45	40	100	1	0.45	10	1	10			YES
72	RB501VM-40	*	FH	TE-17	45	40	100	1	0.55	100	30	10			YES
73	RB540VM-40	*	FH	TE-17	40	40	200	1	0.71	100	15	40			YES
74	RB541VM-40	*	FH	TE-17	40	40	200	1	0.61	100	100	40			YES
75	RB520VM-40	*	FH	TE-17	40	40	200	1	0.55	100	10	40			YES
76	RB521VM-40	*	FH	TE-17	40	40	200	1	0.54	200	90	40			YES
77	RB550VM-40	*	FH	TE-17	40	40	200	1	0.51	200	40	40			YES
78	RB551VM-40	*	FH	TE-17	40	40	200	1	0.43	200	300	40			YES
79	RB560VM-40	*	FH	TE-17	40	40	500	2	0.64	500	40	40			YES
80	RB561VM-40	*	—	TE-17	40	40	500	2	0.56	500	300	40			—
81	RB411VAM-50	*	—	TR	50	20	500	3	0.5	500	30	10			—
82	RB162VAM-20	*	—	TR	25	20	1,000	5	0.4	1,000	1,200	20			—
83	RB161VAM-20	*	—	TR	30	20	1,000	5	0.42	1,000	1,000	20			—
84	RBE1VAM20A	*	—	TR	30	20	1,000	3	0.53	1,000	200	20			—
85	RBE2VAM20A	*	—	TR	30	20	2,000	5	0.46	2,000	700	20			—
86	RSX051VAM30	*	—	TR	30	30	500	5	0.39	500	200	30			—
87	RSX051VYM30	*	FH	TR	30	30	500	5	0.39	500	200	30			YES
88	RSX071VAM30	*	—	TR	30	30	700	5	0.42	700	200	30			—
89	RSX071VYM30	*	FH	TR	30	30	700	5	0.42	700	200	30			YES
90	RB168VAM-30	*	—	TR	30	30	1,000	5	0.73	1,000	0.3	30			—
91	RB168VYM-30	*	FH	TR	30	30	1,000	5	0.73	1,000	0.3	30	YES		
92	RB550VAM-30	*	—	TR	30	30	1,000	3	0.52	1,000	30	10	—		
93	RB550VYM-30	*	FH	TR	30	30	1,000	3	0.52	1,000	30	10	YES		
94	RSX101VAM30	*	—	TR	30	30	1,000	5	0.47	1,000	200	30	—		
95	RSX101VYM30	*	FH	TR	30	30	1,000	5	0.47	1,000	200	30	YES		
96	RSX201VAM30	*	—	TR	30	30	1,500	8	0.46	1,500	300	30	—		
97	RSX201VYM30	*	FH	TR	30	30	1,500	8	0.46	1,500	300	30	YES		
98	RB400VAM-50	*	—	TR	50	40	500	3	0.55	500	50	30	—		
99	RB400VYM-50	*	FH	TR	50	40	500	3	0.55	500	50	30	YES		
100	RB160VAM-40	*	—	TR	40	40	1,000	5	0.55	700	50	40	—		
101	RB160VYM-40	*	FH	TR	40	40	1,000	5	0.55	700	50	40	YES		
102	RB168VAM-40	*	—	TR	40	40	1,000	5	0.79	1,000	0.5	40	—		
103	RB168VYM-40	*	FH	TR	40	40	1,000	5	0.79	1,000	0.5	40	YES		
104	RB160VAM-60	*	—	TR	60	60	1,000	3	0.67	1,000	40	60	—		
105	RB160VYM-60	*	FH	TR	60	60	1,000	3	0.67	1,000	40	60	YES		
106	RB168VYM-60	*	FH	TR	60	60	1,000	5	0.82	1,000	1	60	YES		
107	RB168VAM-60	*	—	TR	60	60	1,000	5	0.82	1,000	1	60	—		
108	RB021VAM90	*	—	TR	90	90	200	5	0.49	200	900	90	—		
109	RB578VAM100	*	—	TR	100	100	700	5	0.85	700	0.2	100	—		
110	RB578VYM100	*	FH	TR	100	100	700	5	0.85	700	0.2	100	YES		
111	RB168VAM100	*	—	TR	100	100	1,000	5	0.84	1,000	0.3	100	—		
112	RB168VYM100	*	FH	TR	100	100	1,000	5	0.84	1,000	0.3	100	YES		
113	RB558VAM150	*	—	TR	150	150	500	3	0.95	500	0.5	150	—		
114	RB558VYM150	*	FH	TR	150	150	500	3	0.95	500	0.5	150	YES		

* : General part No. have no grade code.
 *1 : I_o : Average output current per chip. In case of 1, 2 or 3 chip diodes. I_o indicates average output current of 1, 2 or 3 chips. *2 : Value/Chip
 Package is JEDEC code. () : ROHM Packages

Schottky Barrier Diodes



Schottky Barrier Diodes

Example: **R B 1 6 8 V Y M 1 5 0 F H T R**
Part No. Grade Code Taping Code

Quick Reference No.	Product No.				Absolute Maximum Ratings(Tc=25°C)				Electrical Characteristics(Tj=25°C)*2				Package	Equivalent Circuit Diagram	Automotive Grade AEC-Q101
	Part No.	Grade Code		Taping Code	V _{RM} (V)	V _R (V)	I _O *1 (mA)	I _{FSM} (A)*2 (60Hz.1~)	V _F (V) Max.	I _F (mA)	I _R (μA) Max.	V _B (V)			
		General	Automotive												
115	RB168VAM150	*	—	TR	150	150	1,000	5	0.89	1,000	1	150	(TUMD2M)		—
116	RB168VYM150	—	FH	TR	150	150	1,000	5	0.89	1,000	1	150		YES	
117	RB715Z	*	FH	T2L	40	40	30	0.2	0.37	1	1	10	SOT-723 (VMD3)		YES
118	RB715WM		FH	TL	40	40	30*2	0.2	0.37	1	1	10	SOT-416FL (EMD3F)		YES
119	RB715UM		FH	TL	40	40	30	0.2	0.37	1	1	10	SOT-323FL (UMD3F)		YES
120	BAT54CHM		FH	T116	30	30	200*2	0.6	0.8	100	2	25	SOT-23 (SSD3)		YES
121	BAS40-05HM		FH	T116	40	40	120*2	0.6	0.5	10	1	30	SOT-23 (SSD3)		YES
122	RB495D		FH	T146	40	25	400	2	0.5	200	70	25	SOT-346 (SMD3)		YES
123	RB705D		FH	T146	40	40	30	0.2	0.37	1	1	10	SOT-346 (SMD3)		YES
124	RB425D		FH	T146	40	40	100	1	0.55	100	30	10	SOT-346 (SMD3)		YES
125	RB557WM		FH	TL	—	30	100*2	0.5	0.49	100	10	10	SOT-416FL (EMD3F)		YES
126	RB717UM		FH	TL	45	40	30*2	0.2	0.37	1	1	30	SOT-323FL (UMD3F)		YES
127	BAT54AHM	—	FH	T116	30	30	200*2	0.6	0.8	100	2	25	SOT-23 (SSD3)	YES	
128	BAS40-06HM	—	FH	T116	40	40	120*2	0.6	0.5	10	1	30	SOT-23 (SSD3)	YES	
129	RB548WM	*	FH	TL	—	30	100*2	0.5	0.45	10	0.5	10	SOT-416FL (EMD3F)		YES
130	RB558WM		FH	TL	—	30	100*2	0.5	0.49	100	10	10			YES
131	RB706WM-40		—	FH	TL	45	40	30*2	0.2	0.37	1	0.5			30
132	RB706UM-40	*	FH	TL	45	40	30*2	0.2	0.37	1	1	30	SOT-323FL (UMD3F)		YES
133	BAT54SHM		FH	T116	30	30	200*2	0.6	0.8	100	2	25	SOT-23 (SSD3)		YES
134	BAS40-04HM		FH	T116	40	40	120*2	0.6	0.5	10	1	30	SOT-23 (SSD3)		YES
135	RB706D-40		FH	T146	45	40	30	0.2	0.37	1	1	10	SOT-346 (SMD3)		YES
136	RB461F		—	T106	25	20	700	3	0.49	700	200	20	SOT-323 (UMD3)		—
137	RB451UM	FH	TL	40	40	100	1	0.45	100	90	40	SOT-323FL (UMD3F)	YES		
138	RB450UM	FH	TL	45	40	100	1	0.55	100	10	40	SOT-323FL (UMD3F)	YES		
139	BAT54HM	FH	T116	30	30	200	0.6	0.8	100	2	25	SOT-23 (SSD3)	YES		
140	BAS40HM	FH	T116	40	40	120	0.6	0.5	10	1	30	SOT-23 (SSD3)	YES		
141	RB411D	FH	T146	40	20	500	3	0.5	500	30	10	SOT-346 (SMD3)		YES	
142	RB491D	—	T146	25	20	1,000	3	0.45	1,000	200	20			—	
143	RB420D	FH	T146	40	40	100	1	0.45	10	1	10			YES	
144	RB421D	FH	T146	40	40	100	1	0.55	100	30	10			YES	
145	RB400D	FH	T146	40	40	500	3	0.55	500	50	30			YES	
146	RB481Y	FH	T2R	—	30	100*2	1	0.43	100	30	10	SOT-543 (EMD4)		YES	
147	RB480Y	FH	T2R	—	30	100*2	1	0.53	100	1	10			YES	
148	RB481Y-40	FH	T2R	40	40	200	1	0.45	100	90	40			YES	
149	RB480Y-40	FH	T2R	40	40	200	1	0.55	100	10	40			YES	
150	RB481Y-90	FH	T2R	90	90	100*2	1	0.61	100	100	90			YES	
151	RB480Y-90	FH	T2R	90	90	100*2	1	0.69	100	5	90			YES	
152	RB481K	FH	TL	30	30	200*2	1	0.5	200	30	10	SOT-343 (UMD4)	YES		
153	RB480K	FH	TL	45	40	100*2	1	0.6	100	1	10	SOT-343 (UMD4)	YES		
154	RB496KA	—	TR	—	20	1,000*2	5	0.43	1,000	800	10	SOT-353 (TUMD5)	—		
155	RBE1KA20A	—	TR	30	20	1,000	3	0.43	500	200	20	SOT-353 (TUMD5)	—		
156	RB471E	FH	T148	40	40	100*2	1	0.55	100	30	10	SOT-25 (SMD5)	YES		
157	RB496EA	—	TR	20	20	1,000*2	10	0.4	1,000	500	10	SOT-25T (TSMD5)		—	
158	RBE2EA20A	—	TR	30	20	2,000	5	0.39	1,000	700	20			—	
159	RB552EA	FH	TR	30	30	1,000	7	0.59	500	8	15			YES	
160	RB550EA	FH	TR	30	30	1,400	15	0.49	700	50	30	SOT-25T (TSMD5)	YES		
161	RB530XN	FH	TR	—	30	100*2	1	0.53	100	1	10	SOT-363 (UMD6)		YES	
162	RB531XN	FH	TR	—	30	100*2	1	0.43	100	30	10			YES	
163	RB541XN	FH	TR	—	30	100	0.5	0.35	10	10	10			YES	
164	RB731XN	FH	TR	40	40	30	0.2	0.37	1	1	10			YES	
165	RB731U	FH	T108	40	40	30	0.2	0.37	1	1	10			SOT-457 (SMD6)	YES
166	RB061US-30	—	TR	30	30	2,000	8	0.4	2,000	900	15	(TSMD8)		—	



*: General part No. have no grade code.
 *1: I_O: Average output current per chip. In case of 1, 2 or 3 chip diodes. I_O indicates average output current of 1, 2 or 3 chips. *2: Value/Chip
 Package is JEDEC code. (): ROHM Packages

● Quick Reference for Middle Power Schottky Barrier Diodes(High Efficient type)

V _R (V)	I _o (A)	Package							
		3516 Size				4725 Size			
									
		SOD-123FL (PMDU)				SOD-128 (PMDTM)			
Ultra Low V _F type		Low V _F type		Ultra Low V _F type		Low V _F type			
20	1	RBS1MM40A	1			RBS1LAM40A	7		
	2	RBS2MM40A	2			RBS2LAM40A	8		
		RBS2MM40B	3			RBS2LAM40B	9		
		RBS2MM40C	4			RBS2LAM40C	10		
	3	RBS3MM40A	5			RBS3LAM40A	11		
RBS3MM40B		6			RBS3LAM40B	12			
	5				RBS3LAM40C	13			
					RBS5LAM40A	14			
30	1			RBR1MM30A	15			RBR1LAM30A	31
	2			RBR2MM30A	16			RBR2LAM30A	32
				RBR2MM30B	17				
	3			RBR3MM30A	18			RBR3LAM30A	33
	5						RBR3LAM30B	34	
							RBR5LAM30A	35	
							RBR5LAM30B	36	
40	1			RBR1MM40A	19			RBR1LAM40A	37
	2			RBR2MM40A	20			RBR2LAM40A	38
				RBR2MM40B	21				
				RBR2MM40C	22				
	3			RBR3MM40A	23			RBR3LAM40A	39
			RBR3MM40B	24			RBR3LAM40B	40	
	5						RBR3LAM40C	41	
							RBR5LAM40A	42	
60	1			RBR1MM60A	25			RBR1LAM60A	43
	2			RBR2MM60A	26			RBR2LAM60A	44
				RBR2MM60B	27			RBR2LAM60B	45
				RBR2MM60C	28				
	3			RBR3MM60B	29			RBR3LAM60A	46
			RBR3MM60A	30			RBR3LAM60B	47	
	5						RBR5LAM60A	48	

Package is JEDEC code. () : ROHM Packages

● Quick Reference for Middle Power Schottky Barrier Diodes(Standard type)

V _R (V)	I _o (A)	Package									
		3516 Size				4725 Size					
											
		SOD-123FL(PMDU)				SOD-128(PMDTM)					
Ultra Low V _F type		Low V _F type		Ultra Low I _R type		Ultra Low V _F type		Ultra Low I _R type			
20	1	RB161MM-20	1								
	3	RB051MM-2Y	2			New RB051LAM-40	4				
		5					New RB081LAM-20	5			
						New RSX501LAM20	6				
30	1	RSX101MM-30	3	RB162MM-30	10	RB168MM-30	35		RB168LAM-30	44	
	1.5			RB160MM-30	11						
				RB070MM-30	12						
	2			RB060MM-30	13	RB068MM-30	36	New RSX201LAM30	7	RB068LAM-30	45
								New RSX205LAM30	8		
3							New RSX301LAM30	9			
	5						New RB050LAM-30	22	New RB058LAM-30	46	
							New RB055LAM-30	23			
							New RB080LAM-30	24	New RB088LAM-30	47	
40	1			RB162MM-40	14	RB168MM-40	37	New RB160LAM-40	25	RB168LAM-40	48
				RB160MM-40	15			New RB162LAM-40	26		
				RB160MM-50	16						
	2			RB060MM-40	17	RB068MM-40	38	New RB060LAM-40	27	RB068LAM-40	49
		3						New RB050LAM-40	28	RB058LAM-40	50
	5						New RB055LAM-40	29			
							New RB056LAM-40	30			
									New RB088LAM-40	51	
60	1			RB162MM-60	18	RB168MM-60	39	New RB162LAM-60	31	RB168LAM-60	52
				RB160MM-60	19						
	2			RB060MM-60	20	RB068MM-60	40			RB068LAM-60	53
								New RB050LAM-60	32	RB058LAM-60	54
								New RB055LAM-60	33		
5								New RB088LAM-60	55		
90	1		RB160MM-90	21			New RB160LAM-90	34			
100	1					RB168MM100	41		RB168LAM100	56	
	2					RB068MM100	42		RB068LAM100	57	
	3								RB058LAM100	58	
	5								New RB088LAM100	59	
150	1					RB168MM150	43		RB168LAM150	60	
	2								RB068LAM150	61	
	3								RB058LAM150	62	
	5								New RB088LAM150	63	

Package is JEDEC code. () : ROHM Packages

Schottky Barrier Diodes

Middle Power Schottky Barrier Diodes(High Efficient type)

Quick Reference No.	Product No.			Absolute Maximum Ratings(Tc=25°C)				Electrical Characteristics(Tj=25°C)				Package	Equivalent Circuit Diagram	Automotive Grade AEC-Q101			
	Part No.	Grade Code General	Automotive	Taping Code	V _{RM} (V)	V _R (V)	I _o (A)	I _{FSM} (A) 60Hz.1~	V _F (V) Max.	I _F (A)	I _F (mA) Max.				V _R (V)		
Ultra Low V_F type																	
1	RBS1MM40A			TR	40	20	1	25	0.38	1	0.4	20	SOD-123FL (PMDU)		—		
2	RBS2MM40A			TR	40	20	2	25	0.48	2	0.4	20			—		
3	RBS2MM40B			TR	40	20	2	35	0.41	2	0.5	20			—		
4	RBS2MM40C			TR	40	20	2	45	0.39	2	0.6	20			—		
5	RBS3MM40A			TR	40	20	3	35	0.49	3	0.5	20			—		
6	RBS3MM40B			TR	40	20	3	45	0.45	3	0.6	20			—		
7	RBS1LAM40A	*		TR	40	20	1	40	0.38	1	0.4	20			SOD-128 (PMDTM)		—
8	RBS2LAM40A			TR	40	20	2	40	0.48	2	0.4	20					—
9	RBS2LAM40B			TR	40	20	2	50	0.41	2	0.5	20					—
10	RBS2LAM40C			TR	40	20	2	80	0.37	2	0.8	20					—
11	RBS3LAM40A			TR	40	20	3	50	0.49	3	0.5	20					—
12	RBS3LAM40B			TR	40	20	3	60	0.45	3	0.6	20					—
13	RBS3LAM40C			TR	40	20	3	80	0.4	3	0.8	20					—
14	RBS5LAM40A			TR	40	20	5	80	0.49	5	0.8	20					—

Low V_F type

15	RBR1MM30A			TF	TR	30	30	1	30	0.48	1	0.05	30	SOD-123FL (PMDU)		YES		
16	RBR2MM30A			TF	TR	30	30	2	30	0.53	2	0.05	30			YES		
17	RBR2MM30B			TF	TR	30	30	2	30	0.49	2	0.08	30			YES		
18	RBR3MM30A			TF	TR	30	30	3	30	0.51	3	0.1	30			YES		
19	RBR1MM40A			TF	TR	40	40	1	20	0.52	1	0.05	40			YES		
20	RBR2MM40A			TF	TR	40	40	2	20	0.62	2	0.05	40			YES		
21	RBR2MM40B			TF	TR	40	40	2	30	0.55	2	0.08	40			YES		
22	RBR2MM40C			TF	TR	40	40	2	30	0.52	2	0.1	40			YES		
23	RBR3MM40A			TF	TR	40	40	3	30	0.62	3	0.08	40			YES		
24	RBR3MM40B			TF	TR	40	40	3	30	0.58	3	0.1	40			YES		
25	RBR1MM60A			TF	TR	60	60	1	20	0.53	1	0.075	60			YES		
26	RBR2MM60A			TF	TR	60	60	2	20	0.65	2	0.075	60			YES		
27	RBR2MM60B			TF	TR	60	60	2	30	0.58	2	0.1	60			YES		
28	RBR2MM60C			TF	TR	60	60	2	30	0.55	2	0.12	60			YES		
29	RBR3MM60B			TF	TR	60	60	3	30	0.61	3	0.12	60			YES		
30	RBR3MM60A			TF	TR	60	60	3	30	0.66	3	0.1	60			YES		
31	RBR1LAM30A	*		TF	TR	30	30	1	40	0.48	1	0.05	30			SOD-128 (PMDTM)		YES
32	RBR2LAM30A			TF	TR	30	30	2	45	0.49	2	0.08	30					YES
33	RBR3LAM30A			TF	TR	30	30	3	40	0.58	3	0.05	30					YES
34	RBR3LAM30B			TF	TR	30	30	3	45	0.53	3	0.08	30					YES
35	RBR5LAM30A			TF	TR	30	30	5	75	0.54	5	0.1	30					YES
36	RBR5LAM30B			TF	TR	30	30	5	100	0.49	5	0.15	30					YES
37	RBR1LAM40A			TF	TR	40	40	1	40	0.52	1	0.05	40					YES
38	RBR2LAM40A			TF	TR	40	40	2	45	0.55	2	0.08	40					YES
39	RBR3LAM40A			TF	TR	40	40	3	40	0.69	3	0.05	40	YES				
40	RBR3LAM40B			TF	TR	40	40	3	45	0.62	3	0.08	40	YES				
41	RBR3LAM40C			TF	TR	40	40	3	75	0.55	3	0.1	40	YES				
42	RBR5LAM40A			TF	TR	40	40	5	100	0.53	5	0.2	40	YES				
43	RBR1LAM60A			TF	TR	60	60	1	40	0.53	1	0.075	60	YES				
44	RBR2LAM60A			TF	TR	60	60	2	40	0.65	2	0.075	60	YES				
45	RBR2LAM60B			TF	TR	60	60	2	75	0.52	2	0.15	60	YES				
46	RBR3LAM60A			TF	TR	60	60	3	45	0.66	3	0.1	60	YES				
47	RBR3LAM60B			TF	TR	60	60	3	75	0.56	3	0.15	60	YES				
48	RBR5LAM60A			TF	TR	60	60	5	100	0.55	5	0.25	60	YES				

* : General part No. have no grade code.
Package is JEDEC code. (): ROHM Packages

Schottky Barrier Diodes

Example: **R B 1 6 0 M M - 3 0 T F T R**
Part No. Grade Code Taping Code

Middle Power Schottky Barrier Diodes(Standard type)																	
Quick Reference No.	Product No.			Absolute Maximum Ratings(Tc=25°C)					Electrical Characteristics(Tj=25°C)				Package	Equivalent Circuit Diagram	Automotive Grade AEC-Q101		
	Part No.	General	Automotive	Taping Code	V _{RM} (V)	V _S (V)	I _O (A)	I _{FSM} (A) 60Hz,1ms	V _F (V) Max.	I _F (A)	I _R (mA) Max.	V _R (V)					
Ultra Low V_F type																	
1	RB161MM-20			TR	25	20	1	30	0.35	1	0.7	20	SOD-123FL (PMDU)		—		
2	RB051MM-2Y			TR	20	20	3	30	0.46	3	0.9	20			—		
3	RSX101MM-30			TF	30	30	1	45	0.39	1	0.2	30			YES		
4	New RB051LAM-40	*		TR	40	20	3	80	0.45	3	0.15	15			—		
5	New RB081LAM-20			TR	25	20	5	80	0.45	5	0.7	20			—		
6	New RSX501LAM20			TR	20	20	5	100	0.39	3	0.5	20			—		
7	New RSX201LAM30			TF	30	30	2	60	0.44	2	0.15	30			YES		
8	New RSX205LAM30			TF	30	30	2	60	0.49	2	0.2	30			YES		
9	New RSX301LAM30			TF	30	30	3	100	0.42	3	0.2	30			YES		
Low V_F type																	
10	RB162MM-30			TF	30	30	1	30	0.52	1	0.1	30	SOD-123FL (PMDU)		YES		
11	RB160MM-30			TF	30	30	1	30	0.48	1	0.05	30			YES		
12	RB070MM-30			TF	30	30	1.5	30	0.49	1.5	0.05	30			YES		
13	RB060MM-30			TF	30	30	2	55	0.49	2	0.05	30			YES		
14	RB162MM-40			TF	40	40	1	30	0.55	1	0.1	40			YES		
15	RB160MM-40			TF	40	40	1	30	0.51	1	0.03	40			YES		
16	RB160MM-50			TF	50	40	1	30	0.51	1	0.03	40			YES		
17	RB060MM-40			TF	40	40	2	30	0.56	2	0.5	40			YES		
18	RB162MM-60			TF	60	60	1	20	0.65	1	0.1	60			YES		
19	RB160MM-60			TF	60	60	1	30	0.55	1	0.05	60			YES		
20	RB060MM-60			TF	60	60	2	30	0.61	2	0.05	60			YES		
21	RB160MM-90			TF	90	90	1	30	0.73	1	0.1	90			YES		
22	New RB050LAM-30	*		TF	30	30	3	100	0.45	3	0.15	30			YES		
23	New RB055LAM-30			TF	30	30	3	55	0.55	3	0.05	30			YES		
24	New RB080LAM-30			TF	30	30	5	100	0.51	5	0.15	30			YES		
25	New RB160LAM-40			TF	40	40	1	50	0.55	1	0.1	40			YES		
26	New RB162LAM-40			TF	40	40	1	40	0.55	1	0.1	40			YES		
27	New RB060LAM-40			TF	40	40	2	80	0.50	2	0.1	40			YES		
28	New RB050LAM-40			TF	40	40	3	80	0.55	3	0.1	40			YES		
29	New RB055LAM-40			TF	40	40	3	70	0.62	3	0.1	40			YES		
30	New RB056LAM-40			TF	40	40	3	50	0.67	3	0.05	40			YES		
31	New RB162LAM-60			TF	60	60	1	40	0.65	1	0.1	60			YES		
32	New RB050LAM-60			TF	60	60	3	80	0.56	3	0.1	60			YES		
33	New RB055LAM-60			TF	60	60	3	50	0.68	3	0.07	60			YES		
34	New RB160LAM-90			TF	95	90	1	50	0.73	1	0.1	90			YES		
Ultra Low I_R type																	
35	RB168MM-30			TF	30	30	1	30	0.69	1	0.0006	30			SOD-123FL (PMDU)		YES
36	RB068MM-30			TF	30	30	2	50	0.7	2	0.0008	30					YES
37	RB168MM-40			TF	40	40	1	40	0.65	1	0.00055	40					YES
38	RB068MM-40			TF	40	40	2	40	0.725	2	0.00055	40					YES
39	RB168MM-60			TF	60	60	1	40	0.68	1	0.0015	60					YES
40	RB068MM-60			TF	60	60	2	40	0.765	2	0.0015	60					YES
41	RB168MM100			TF	100	100	1	40	0.81	1	0.0004	100					YES
42	RB068MM100			TF	100	100	2	40	0.87	2	0.0004	100					YES
43	RB168MM150			TF	150	150	1	35	0.84	1	0.004	150	YES				
44	RB168LAM-30			TF	30	30	1	40	0.69	1	0.0006	30	YES				
45	RB068LAM-30			TF	30	30	2	50	0.7	2	0.0008	30	YES				
46	RB058LAM-30			TF	30	30	3	80	0.68	3	0.0025	30	YES				
47	New RB088LAM-30			TF	30	30	5	80	0.69	5	0.0025	30	YES				
48	RB168LAM-40			TF	40	40	1	40	0.69	1	0.0005	40	YES				
49	RB068LAM-40	*		TF	40	40	2	50	0.69	2	0.001	40	YES				
50	RB058LAM-40			TF	40	40	3	90	0.69	3	0.005	40	YES				
51	New RB088LAM-40			TF	40	40	5	90	0.71	5	0.0036	40	YES				
52	RB168LAM-60			TF	60	60	1	40	0.68	1	0.0015	60	YES				
53	RB068LAM-60			TF	60	60	2	70	0.68	2	0.002	60	YES				
54	RB058LAM-60			TF	60	60	3	90	0.64	3	0.004	60	YES				
55	New RB088LAM-60			TF	60	60	5	90	0.71	5	0.004	60	YES				
56	RB168LAM100			TF	100	100	1	40	0.81	1	0.0004	100	YES				
57	RB068LAM100			TF	100	100	2	70	0.81	2	0.0015	100	YES				
58	RB058LAM100			TF	100	100	3	80	0.81	3	0.003	100	YES				
59	New RB088LAM100			TF	100	100	5	80	0.87	5	0.003	100	YES				
60	RB168LAM150			TF	150	150	1	50	0.84	1	0.0025	150	YES				
61	RB068LAM150			TF	150	150	2	70	0.81	2	0.003	150	YES				
62	RB058LAM150			TF	150	150	3	80	0.84	3	0.003	150	YES				
63	New RB088LAM150			TF	150	150	5	80	0.9	5	0.003	150	YES				

* : General part No. have no grade code.
 Package is JEDEC code. (): ROHM Packages

Schottky Barrier Diodes

●Quick Reference for Power Schottky Barrier Diodes(High Efficient type)

V _R (V)	I _O (A)	Package												
		TO-252 (DPAK)		TO-263S (D2PAK)		TO-220FN (<3pin>)		TO-220FN (<2pin>)						
Low V _F type		Low I _R type		Low V _F type		Low I _R type		Low V _F type		Low I _R type				
30	10	RBR10BM30A	1		RBR10NS30A	10			RBR10T30A	22				
	15	RBR15BM30A	2											
	20	RBR20BM30A	3		RBR20NS30A	11		RBR20T30A	23					
	30				RBR30NS30A	12		RBR30T30A	24					
	40				New RBR40NS30A	13								
40/45	10	RBR10BM40A	4	RBQ10BM45A	31	RBR10NS40A	14	RBQ10NS45A	37	RBR10T40A	25	RBQ10T45A	44	
	15	RBR15BM40A	5	RBQ15BM45A	32									
	20	RBR20BM40A	6	RBQ20BM45A	33	RBR20NS40A	15	RBQ20NS45A	38	RBR20T40A	26	RBQ20T45A	45	
	30				RBR30NS40A	16	RBQ30NS45A	39	RBR30T40A	27	RBQ30T45A	46	RBQ30TB45B	50
	40				New RBR40NS40A	17	RBQ30NS45B	43						
60/65	10	RBR10BM60A	7	RBQ10BM65A	34	RBR10NS60A	18	RBQ10NS65A	40	RBR10T60A	28	RBQ10T65A	47	
	15	RBR15BM60A	8	RBQ15BM65A	35									
	20	RBR20BM60A	9	RBQ20BM65A	36	RBR20NS60A	19	RBQ20NS65A	41	RBR20T60A	29	RBQ20T65A	48	
	30				RBR30NS60A	20	RBQ30NS65A	42	RBR30T60A	30	RBQ30T65A	49		
	40				RBR40NS60A	21								

Package is JEDEC code. (): ROHM Packages

●Quick Reference for Power Schottky Barrier Diodes(Standard type)

V _R (V)	I _O (A)	Package											
		TO-252 (DPAK)		TO-263S (D2PAK)		TO-220FN (<3pin>)		TO-220FN (<3pin>)					
Low V _F type		Ultra Low I _R type		Low V _F type		Ultra Low I _R type		Low V _F type		Ultra Low I _R type			
30	5		RB078BM30S	24									
	6	RB095BM-30	1	RB098BM-30	25								
	10	RB085BM-30	2	RB088BM-30	26			RB088NS-30	36		RB088T-30	57	
	20							RB218NS-30	37		RB218T-30	58	
	30							RB228NS-30	38		RB228T-30	59	
40	40							RB238NS-30	39		RB238T-30	60	
	5		RB075BM40S	27									
	6	RB095BM-40	3	RB098BM-40	28					RB095T-40	10		
	10	RB085BM-40	4	RB088BM-40	29			RB088NS-40	40	RB085T-40	11	RB088T-40	61
	15									RB205T-40	12		
60	20							RB218NS-40	41	RB215T-40	13	RB218T-40	62
	30				RB225NS-40	9	RB228NS-40	42	RB225T-40	14	RB228T-40	63	
	40						RB238NS-40	43		14	RB238T-40	64	
	6	RB095BM-60	5	RB098BM-60	30					RB095T-60	15		
	10	RB085BM-60	6	RB088BM-60	31			RB088NS-60	44	RB085T-60	16	RB088T-60	65
90	15									RB205T-60	17		
	20							RB218NS-60	45	RB215T-60	18	RB218T-60	66
	30							RB228NS-60	46	RB225T-60	19	RB228T-60	67
	40							RB238NS-60	47		19	RB238T-60	68
	6	RB095BM-90	7							RB095T-90	20		
100	10	RB085BM-90	8							RB085T-90	21		
	15									RB205T-90	22		
	20									RB215T-90	23		
	6		RB098BM100	32									
	10		RB088BM100	33				RB088NS100	48			RB088T100	69
150	20							RB218NS100	49			RB218T100	70
	30							RB228NS100	50			RB228T100	71
	40							RB298NS100	51			RB298T100	42
	6		RB098BM150	34				RB238NS100	52			RB238T100	73
	10		RB088BM150	35								RB088T150	74
150	20							RB218NS150	54			RB218T150	75
	30							RB228NS150	55			RB228T150	76
	40							RB238NS150	56			RB238T150	77

Package is JEDEC code. (): ROHM Packages

Schottky Barrier Diodes

Example: **RBR10BM30AFHTL**
 Part No. Grade Code Taping Code

Power Schottky Barrier Diodes(High Efficient type)																
Quick Reference No.	Product No.			Absolute Maximum Ratings(Tc=25°C)				Electrical Characteristics(Tj=25°C)				Package	Equivalent Circuit Diagram	Automotive Grade AEC-Q101		
	Part No.	General	Automotive	Taping Code	V _{RM} (V)	V _R (V)	I _o *1(A)	I _{FSM} (A)*2	V _F (V) Max.	I _F (A)	I _R (mA) Max.				V _R (V)	
Low V_F type																
1	RBR10BM30A			FH	TL	30	30	10	50	0.55	5	0.1	30	TO-252 (DPAK)		YES
2	RBR15BM30A			FH	TL	30	30	15	100	0.51	7.5	0.2	30			YES
3	RBR20BM30A			FH	TL	30	30	20	100	0.51	10	0.3	30			YES
4	RBR10BM40A			FH	TL	40	40	10	50	0.62	5	0.12	40			YES
5	RBR15BM40A			FH	TL	40	40	15	100	0.55	7.5	0.24	40			YES
6	RBR20BM40A			FH	TL	40	40	20	100	0.55	10	0.36	40			YES
7	RBR10BM60A			FH	TL	60	60	10	50	0.65	5	0.2	60			YES
8	RBR15BM60A			FH	TL	60	60	15	100	0.58	7.5	0.4	60			YES
9	RBR20BM60A			FH	TL	60	60	20	100	0.59	10	0.6	60			YES
10	RBR10NS30A		*	FH	TL	30	30	10	50	0.55	5	0.1	30	TO-263S (D2PAK)		YES
11	RBR20NS30A			FH	TL	30	30	20	100	0.55	10	0.2	30			YES
12	RBR30NS30A			FH	TL	30	30	30	100	0.55	15	0.3	30			YES
13	New RBR40NS30A			FH	TL	30	30	40	100	0.52	20	0.6	30			YES
14	RBR10NS40A			FH	TL	40	40	10	50	0.62	5	0.12	40			YES
15	RBR20NS40A			FH	TL	40	40	20	100	0.62	10	0.24	40			YES
16	RBR30NS40A			FH	TL	40	40	30	100	0.62	15	0.36	40			YES
17	New RBR40NS40A			FH	TL	40	40	40	100	0.55	20	0.43	40			YES
18	RBR10NS60A			FH	TL	60	60	10	50	0.65	5	0.2	60			YES
19	RBR20NS60A			FH	TL	60	60	20	100	0.64	10	0.4	60			YES
20	RBR30NS60A			FH	TL	60	60	30	100	0.67	15	0.6	60			YES
21	RBR40NS60A			FH	TL	60	60	40	100	0.6	20	0.8	60	YES		
22	RBR10T30A	NZ		HZ	C9	30	30	10	50	0.55	5	0.1	30	TO-220FN <3pin>		YES
23	RBR20T30A	NZ		HZ	C9	30	30	20	100	0.55	10	0.2	30			YES
24	RBR30T30A	NZ		HZ	C9	30	30	30	100	0.55	15	0.3	30			YES
25	RBR10T40A	NZ		HZ	C9	40	45	10	50	0.62	5	0.12	40			YES
26	RBR20T40A	NZ		HZ	C9	40	45	20	100	0.62	10	0.24	40			YES
27	RBR30T40A	NZ		HZ	C9	40	45	30	100	0.62	15	0.36	40			YES
28	RBR10T60A	NZ		HZ	C9	60	60	10	50	0.65	5	0.2	60			YES
29	RBR20T60A	NZ		HZ	C9	60	60	20	100	0.64	10	0.4	60			YES
30	RBR30T60A	NZ		HZ	C9	60	60	30	100	0.67	15	0.6	60			YES
Low I_R type																
31	RBQ10BM45A			FH	TL	45	45	10	50	0.65	5	0.07	45	TO-252 (DPAK)		YES
32	RBQ15BM45A			FH	TL	45	45	15	100	0.59	7.5	0.14	45			YES
33	RBQ20BM45A			FH	TL	45	45	20	100	0.59	10	0.2	45			YES
34	RBQ10BM65A			FH	TL	65	65	10	50	0.69	5	0.07	65			YES
35	RBQ15BM65A			FH	TL	65	65	15	100	0.63	7.5	0.14	65			YES
36	RBQ20BM65A			FH	TL	65	65	20	100	0.63	10	0.2	65			YES
37	RBQ10NS45A		*	FH	TL	45	45	10	100	0.65	5	0.07	45	TO-263S (D2PAK)		YES
38	RBQ20NS45A			FH	TL	45	45	20	100	0.65	10	0.14	45			YES
39	RBQ30NS45A			FH	TL	45	45	30	100	0.65	15	0.2	45			YES
40	RBQ10NS65A			FH	TL	65	65	10	100	0.69	5	0.07	65			YES
41	RBQ20NS65A			FH	TL	65	65	20	100	0.69	10	0.14	65			YES
42	RBQ30NS65A			FH	TL	65	65	30	100	0.69	15	0.2	65			YES
43	RBQ30NS45B			FH	TL	45	45	30	100	0.59	30	0.7	45		YES	
44	RBQ10T45A	NZ		HZ	C9	45	45	10	100	0.65	5	0.07	45	TO-220FN <3pin>		YES
45	RBQ20T45A	NZ		HZ	C9	45	45	20	100	0.65	10	0.14	45			YES
46	RBQ30T45A	NZ		HZ	C9	45	45	30	100	0.65	15	0.2	45			YES
47	RBQ10T65A	NZ		HZ	C9	65	65	10	100	0.69	5	0.07	65			YES
48	RBQ20T65A	NZ		HZ	C9	65	65	20	100	0.69	10	0.14	65			YES
49	RBQ30T65A	NZ		HZ	C9	65	65	30	100	0.69	15	0.2	65	YES		
50	RBQ30T45B	NZ		HZ	C9	45	45	30	100	0.59	30	0.7	45		YES	

*: General part No. have no grade code.
 *1: I_o: Average rectified output current per die. In case of 2 dies, I_o indicates average output current of 2 dies.
 *2: Value/Die
 Package is JEDEC code. () : ROHM Packages

Schottky Barrier Diodes

Schottky Barrier Diodes

 Example: **R B 0 9 5 B M - 3 0 F H T L**
Part No. Grade Code Taping Code

Power Schottky Barrier Diodes(Standard type)															
Quick Reference No.	Product No.				Absolute Maximum Ratings(Tc=25°C)				Electrical Characteristics(Tj=25°C)*2				Package	Equivalent Circuit Diagram	Automotive Grade AEC-Q101
	Part No.	Grade Code General	Automotive	Taping Code	V _{RM} (V)	V _R (V)	I _O *1 (A)	I _{FSM} (A)*2 60Hz.1~	V _F (V) Max.	I _F (A)	I _R (mA) Max.	V _R (V)			
Low V_F type															
1	RB095BM-30	*	FH	TL	35	30	6	50	0.425	3	0.2	30	TO-252 (DPAK)		YES
2	RB085BM-30		FH	TL	35	30	10	50	0.48	4	0.3	30			YES
3	RB095BM-40		FH	TL	45	40	6	50	0.55	3	0.1	40			YES
4	RB085BM-40		FH	TL	45	40	10	50	0.55	5	0.2	40			YES
5	RB095BM-60		FH	TL	60	60	6	50	0.58	3	0.3	60			YES
6	RB085BM-60		FH	TL	60	60	10	50	0.58	5	0.3	60			YES
7	RB095BM-90		FH	TL	90	90	6	50	0.75	3	0.15	90			YES
8	RB085BM-90		FH	TL	90	90	10	50	0.83	5	0.15	90			YES
9	RB225NS-40		FH	TL	40	40	30	50	0.55	15	0.5	40			TO-263S (D2PAK)
10	RB095T-40	NZ	HZ	C9	45	40	6	100	0.55	3	0.1	40	TO-220FN <3pin>		YES
11	RB085T-40	NZ	HZ	C9	45	40	10	100	0.55	5	0.2	40			YES
12	RB205T-40	NZ	HZ	C9	45	40	15	100	0.55	7.5	0.3	40			YES
13	RB215T-40	NZ	HZ	C9	45	40	20	100	0.55	10	0.5	40			YES
14	RB225T-40	NZ	HZ	C9	40	40	30	100	0.63	15	0.5	40			YES
15	RB095T-60	NZ	HZ	C9	60	60	6	100	0.58	3	0.1	60			YES
16	RB085T-60	NZ	HZ	C9	60	60	10	100	0.58	5	0.3	60			YES
17	RB205T-60	NZ	HZ	C9	60	60	15	100	0.58	7.5	0.6	60			YES
18	RB215T-60	NZ	HZ	C9	60	60	20	100	0.58	10	0.6	60			YES
19	RB225T-60	NZ	HZ	C9	60	60	30	100	0.63	15	0.6	60			YES
20	RB095T-90	NZ	HZ	C9	90	90	6	100	0.75	3	0.15	90			YES
21	RB085T-90	NZ	HZ	C9	90	90	10	100	0.83	5	0.15	90			YES
22	RB205T-90	NZ	HZ	C9	90	90	15	100	0.78	7.5	0.3	90			YES
23	RB215T-90	NZ	HZ	C9	90	90	20	100	0.75	10	0.4	90			YES
Ultra Low I_R type															
24	RB078BM30S	*	FH	TL	35	30	5	50	0.72	5	0.005	30	TO-252 (DPAK)		YES
25	RB098BM-30		FH	TL	35	30	6	50	0.72	3	0.0015	30			YES
26	RB088BM-30		FH	TL	35	30	10	50	0.72	5	0.003	30			YES
27	RB075BM40S	*	FH	TL	40	40	5	50	0.75	5	0.005	40	TO-263S (D2PAK)		YES
28	RB098BM-40		FH	TL	45	40	6	50	0.77	3	0.0015	40			YES
29	RB088BM-40		FH	TL	45	40	10	50	0.77	5	0.003	40			YES
30	RB098BM-60		FH	TL	60	60	6	50	0.83	3	0.0015	60			YES
31	RB088BM-60		FH	TL	60	60	10	50	0.83	5	0.003	60			YES
32	RB098BM100		FH	TL	110	100	6	100	0.77	3	0.003	100			YES
33	RB088BM100		FH	TL	100	100	10	100	0.87	5	0.005	100			YES
34	RB098BM150		FH	TL	150	150	6	100	0.83	3	0.007	150			YES
35	RB088BM150		FH	TL	150	150	10	100	0.88	5	0.015	150			YES
36	RB088NS-30		FH	TL	35	30	10	50	0.72	5	0.003	30			YES
37	RB218NS-30		FH	TL	35	30	20	100	0.72	10	0.005	30			YES
38	RB228NS-30		FH	TL	35	30	30	100	0.72	15	0.01	30			YES
39	RB238NS-30		FH	TL	35	30	40	100	0.75	20	0.012	30			YES
40	RB088NS-40		FH	TL	45	40	10	50	0.77	5	0.003	40			YES
41	RB218NS-40		FH	TL	45	40	20	100	0.77	10	0.005	40	YES		
42	RB228NS-40		FH	TL	45	40	30	100	0.77	15	0.01	40	YES		
43	RB238NS-40		FH	TL	45	40	40	100	0.8	20	0.012	40	YES		
44	RB088NS-60		FH	TL	60	60	10	50	0.83	5	0.003	60	YES		
45	RB218NS-60		FH	TL	60	60	20	100	0.83	10	0.005	60	YES		
46	RB228NS-60		FH	TL	60	60	30	100	0.83	15	0.01	60	YES		
47	RB238NS-60		FH	TL	60	60	40	100	0.86	20	0.012	60	YES		
48	RB088NS100		FH	TL	110	100	10	100	0.87	5	0.005	100	YES		
49	RB218NS100		FH	TL	110	100	20	100	0.87	10	0.007	100	YES		
50	RB228NS100		FH	TL	110	100	30	100	0.87	15	0.005	100	YES		
51	RB298NS100		FH	TL	110	100	30	100	0.87	15	0.01	100	YES		
52	RB238NS100		FH	TL	110	100	40	100	0.86	20	0.02	100	YES		
53	RB088NS150		FH	TL	150	150	10	50	0.88	5	0.015	150	YES		
54	RB218NS150		FH	TL	150	150	20	100	0.88	10	0.02	150	YES		
55	RB228NS150		FH	TL	150	150	30	100	0.88	15	0.025	150	YES		
56	RB238NS150		FH	TL	150	150	40	100	0.87	20	0.03	150	YES		
57	RB088T-30	NZ	HZ	C9	35	30	10	50	0.72	5	0.003	30	YES		
58	RB218T-30	NZ	HZ	C9	35	30	20	100	0.72	10	0.005	30	YES		
59	RB228T-30	NZ	HZ	C9	35	30	30	100	0.72	15	0.01	30	YES		
60	RB238T-30	NZ	HZ	C9	35	30	40	100	0.75	20	0.012	30	YES		
61	RB088T-40	NZ	HZ	C9	45	40	10	50	0.77	5	0.003	40	YES		
62	RB218T-40	NZ	HZ	C9	45	40	20	100	0.77	10	0.005	40	YES		
63	RB228T-40	NZ	HZ	C9	45	40	30	100	0.77	15	0.01	40	YES		
64	RB238T-40	NZ	HZ	C9	45	40	40	100	0.8	20	0.012	40	YES		
65	RB088T-60	NZ	HZ	C9	60	60	10	50	0.83	5	0.003	60	YES		
66	RB218T-60	NZ	HZ	C9	60	60	20	100	0.83	10	0.005	60	YES		
67	RB228T-60	NZ	HZ	C9	60	60	30	100	0.83	15	0.01	60	YES		
68	RB238T-60	NZ	HZ	C9	60	60	40	100	0.86	20	0.012	60	YES		
69	RB088T100	NZ	HZ	C9	110	100	10	100	0.87	5	0.005	100	YES		
70	RB218T100	NZ	HZ	C9	110	100	20	100	0.87	10	0.007	100	YES		
71	RB228T100	NZ	HZ	C9	110	100	30	100	0.87	15	0.005	100	YES		
72	RB298T100	NZ	HZ	C9	110	100	30	100	0.87	15	0.01	100	YES		
73	RB238T100	NZ	HZ	C9	110	100	40	100	0.86	20	0.02	100	YES		
74	RB088T150	NZ	HZ	C9	150	150	10	50	0.88	5	0.015	150	YES		
75	RB218T150	NZ	HZ	C9	150	150	20	100	0.88	10	0.02	150	YES		
76	RB228T150	NZ	HZ	C9	150	150	30	100	0.88	15	0.025	150	YES		
77	RB238T150	NZ	HZ	C9	150	150	40	100	0.87	20	0.03	150	YES		

*: General part No. have no grade code.

 *1: I_O: Average rectified output current per die. In case of 2 dies, I_O indicates average output current of 2 dies.

*2: Value/Die

Package is JEDEC code. () : ROHM Packages

Fast Recovery Diodes

Small Signal/Middle Power Fast Recovery Diodes

Fast Recovery Diodes

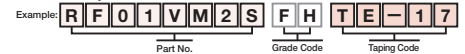

V _R (V)	I _o (A)	Surface Mount type																		
		1608 Size SOD-523 (EMD2)	2512 Size SOD-323FL (UMD2)	2514 Size (TUMD2M)		2514 Size (TUMD2SM)		3516 Size SOD-123FL (PMDU)	4725 Size SOD-128 (PMDTM)	2928 Size SOT-457T (TSMD6)										
100	0.5			RF05VAM1S RF05VYM1S	3 4															
200	0.4																		RF04UA2D	24
	0.5			RF05VAM2S RF05VYM2S	5 6				RFC02MM2S	9										
	0.7								RF071MM2S	10										
	0.8								RF081MM2S	11										
	1																			
	1.1																		RF101LAM2S	12
	1.1																		RF081LAM2S	13
2																		RF201LAM2S RF202LAM2S	14 15	
3																		RF302LAM2S	16	
250	0.1			RF01VM2S	2															
400	1																			
	1.5																			
450	0.1	RFU01SM4S	1																	
600	0.2								RFU02VSM6S	7										
	0.8																			
	1.5																			
700	0.8																			
800	0.2								RFU02VSM8S	8										

Package is JEDEC code. () : ROHM Packages

Small Signal/Middle Power Fast Recovery Diodes																		
Quick Reference No.	Product No.				Absolute Maximum Ratings (T _c =25°C or T _l =25°C)				Absolute Maximum Ratings (T _j =25°C)*2							Package	Equivalent Circuit Diagram	Automotive Grade AEC-Q101
	Part No.	Grade Code		Taping Code	V _{RM} (V)	V _R (V)	I _o (A)	I _{FSM} (A) 60Hz. 1~	V _F (V) Max.		I _R (μA) Max.		trr(ns) Max.					
		General	Automotive						I _F (A)	I _R (A)	V _R (V)	I _F (A)	I _R (A)					
1	RFU01SM4S	—	—	T2R	450	450	0.1	1	1.8	0.1	10	450	35	0.1	0.1	SOD-523 (EMD2)		—
2	RF01VM2S	*	FH	TE-17	250	250	0.1	1	1.2	0.1	10	250	50	*3		SOD-323FL (UMD2)		YES
3	RF05VAM1S	—	—	TR	100	100	0.5	6	0.98	0.5	10	100	25	0.5	1	(TUMD2M)		—
4	RF05VYM1S	—	FH	TR	100	100	0.5	6	0.98	0.5	10	100	25	0.5	1			YES
5	RF05VAM2S	*	—	TR	200	200	0.5	6	0.98	0.5	10	200	25	0.5	1			—
6	RF05VYM2S	—	FH	TR	200	200	0.5	6	0.98	0.5	10	200	25	0.5	1			YES
7	RFU02VSM6S	—	—	TR	600	600	0.2	1	2.2	0.2	10	600	35	0.1	0.1	(TUMD2M)		—
8	RFU02VSM8S	—	—	TR	800	800	0.2	1	3	0.2	10	800	35	0.1	0.1			—
9	RFC02MM2S	—	—	TR	200	200	0.5	10	0.95	0.5	1	200	35	0.1	0.2	SOD-123FL (PMDU)		YES
10	RF071MM2S	—	FH	TR	200	200	0.7	15	0.85	0.7	10	200	25	0.5	1			YES
11	RF081MM2S	—	FH	TR	200	200	0.8	20	0.95	0.8	10	200	25	0.5	1			YES
12	RF101LAM2S	—	FH	TR	200	200	1	20	0.87	1	10	200	25	0.5	1			YES
13	RF081LAM2S	—	FH	TR	200	200	1.1	25	0.98	1	10	200	25	0.5	1	YES		
14	RF201LAM2S	—	FH	TR	200	200	2	20	0.87	2	10	200	25	0.5	1	YES		
15	RF202LAM2S	—	FH	TR	200	200	2	20	0.93	2	10	200	25	0.5	1	YES		
16	RF302LAM2S	*	—	TR	200	200	3	20	0.92	3	10	200	25	0.5	1	SOD-128 (PMDTM)		YES
17	New RF071LAM4S	—	FH	TR	400	400	1	15	1.25	0.7	10	400	25	0.5	1			YES
18	New RF101LAM4S	—	FH	TR	400	400	1	25	1.25	1	10	400	25	0.5	1			YES
19	New RF201LAM4S	—	FH	TR	400	400	1.5	50	1.2	1.5	1	400	30	0.5	1			YES
20	New RFN2LAM4S	—	FH	TR	400	400	1.5	50	1.2	1.5	1	400	30	0.5	1			YES
21	RFN1LAM6S	—	FH	TR	600	600	0.8	15	1.45	0.8	1	600	35	0.5	1			YES
22	RFN2LAM6S	—	FH	TR	600	600	1.5	40	1.55	1.5	1	600	35	0.5	1			YES
23	RFN1LAM7S	—	FH	TR	700	700	0.8	15	1.5	0.8	1	700	80	0.5	1			YES
24	RF04UA2D	—	—	TR	200	200	0.4	1	0.98	0.2	10	200	25	0.5	1	SOT-457T (TSMD6)		

*General part No. have no grade code.

*1 : I_o : Average output current per chip. In case of 2 chip diodes. I_o indicates average output current of 2 chips. *2 : Value/Chip *3 : V_R=6V, I_F=10mA, I_{rr}=0.1nA
 Package is JEDEC code. () : ROHM Packages.

Diodes C

Fast Recovery Diodes

Quick Reference for Power Fast Recovery Diodes

V _R (V)	I _o (A)	Surface Mount type				Leaded type														
		TO-252 (DPAK)	TO-263S (D2PAK)	TO-220FN <2pin>	TO-220FN <3pin>	TO-220NFM <2pin>	TO-220AC	TO-220ACFP	TO-247											
200	3	RF301BM2S RFN3BM2S	21 22																	
	5	RF501BM2S RFN5BM2S	23 24																	
	6	RF601BM2D RFN6BM2D	1 2				RF601T2D RFN6T2D	8 9												
	10		RF1001NS2D	3			RF1001T2D RFN10T2D	10 11												
	16		RF1601NS2D	4			RF1601T2D RFN16T2D	12 13												
	20		RF2001NS2D	5			RF2001T2D RFN20T2D	14 15												
300	20		RF2001NS3D	6		RF2001T3D	16	RF1501TF3S	55											
350	5	RFN5BM3S	25																	
	10	RFN10BM3S	33	RFN10NS3S	35															
	20		RFN20NS3S RFUH25NS3S RFUH20NS3S	36 37 38	RFUH25TB3S RFUH20TB3S	49 50														
430	10		RFN10NS4S RFUH10NS4S	39 40	RFN10TB4S RFUH10TB4S	51 52														
	20		RFN20NS4S RFUH20NS4S	41 42	RFN20TB4S RFUH20TB4S	53 54														
600	3	RFN3BM6S RF305BM6S	26 27																	
	5	RFN5BM6S RF505BM6S RFV5BM6S	28 29 30 31					RFN5TF6S RF505TF6S RFUH5TF6S	56 57 58		RFN5L5J6S	65								
	8	RFV8BM6S	32							RFV8TG6S RFV8TJ6S	75 76	RFV8TJ6S RFV8TJ6S	66 67							
	10	RFN10BM6S	34	RFN10NS6S RFUH10NS6S	43 44			RFN10TF6S RF1005TF6S RFUH10TF6S	59 60 61			RFN10TJ6S	68							
	12									RFV12TG6S	77	RFV12TJ6S	69							
	15									RFV15TG6S	78	RFN15TJ6S RFV15TJ6S	70 71							
	20		RFN20NS6S RFUH20NS6S	45 46				RFN20TF6S RFUH20TF6S	62 63			RFN20TJ6S RFN20TJ6S RFUH20TJ6S	72 73 74							
	30									RFV30TG6S	79			RFN30TS6D RFUH30TS6D RFN30TS6S RFUH30TS6S	17 18 47 48					
	60													RFN60TS6D RFUH60TS6D	19 20					
	800	5						RFN5TF8S	64											
10		RFN10NS8D	7																	

Package is JEDEC code. (): ROHM Packages

Power Fast Recovery Diodes 1																	
Quick Reference No.	Product No.				Absolute Maximum Ratings(Tc=25°C)				Electrical Characteristics(Tj=25°C)*2						Package	Equivalent Circuit Diagram	Automotive Grade AEC-Q101
	Part No.	Grade Code		Taping Code	V _{RM} (V)	V _R (V)	I _O *1(A)	I _{FSM} (A)*2 60Hz,1ms	V _F (V) Max.	I _F (A)	I _R (μA) Max.	V _R (V)	t _{rr} (ns)/ Max.	I _F (A)			
1	RF601BM2D	*	FH	TL	200	200	6	60	0.93	3	10	200	25	0.5	1	TO-252 (DPAK)	YES
2	RFN6BM2D		FH	TL	200	200	6	40	0.98	3	10	200	25	0.5	1		YES
3	RF1001NS2D		FH	TL	200	200	10	80	0.93	5	10	200	25	0.5	1		YES
4	RF1601NS2D		FH	TL	200	200	16	100	0.93	8	10	200	30	0.5	1		YES
5	RF2001NS2D		FH	TL	200	200	20	100	0.93	10	10	200	30	0.5	1		YES
6	RF2001NS3D		FH	TL	350	300	20	100	1.3	10	10	300	25	0.5	1		YES
7	RFN10NS8D		FH	TL	800	800	10	60	2.1	5	10	800	40	0.5	1		YES
8	RF601T2D	NZ	HZ	C9	200	200	6	60	0.93	3	10	200	25	0.5	1	TO-220FN <3pin>	YES
9	RFN6T2D	NZ	HZ	C9	200	200	6	40	0.98	3	10	200	25	0.5	1		YES
10	RF1001T2D	NZ	HZ	C9	200	200	10	80	0.93	5	10	200	30	0.5	1		YES
11	RFN10T2D	NZ	HZ	C9	200	200	10	80	0.98	5	10	200	25	0.5	1		YES
12	RF1601T2D	NZ	HZ	C9	200	200	16	100	0.93	8	10	200	30	0.5	1		YES
13	RFN16T2D	NZ	HZ	C9	200	200	16	100	0.98	8	10	200	30	0.5	1		YES
14	RF2001T2D	NZ	HZ	C9	200	200	20	100	0.93	10	10	200	30	0.5	1		YES
15	RFN20T2D	NZ	HZ	C9	200	200	20	100	0.98	10	10	200	30	0.5	1	YES	
16	RF2001T3D	NZ	HZ	C9	350	300	20	100	1.3	10	10	300	25	0.5	1	YES	
17	RFN30TS6D	G	—	C11	600	600	30	120	1.55	15	10	600	55	0.5	1	TO-247	—
18	RFUH30TS6D	G	—	C11	600	600	30	80	2.8	15	10	600	30	0.5	1		—
19	RFN60TS6D	G	—	C11	600	600	60	180	1.55	30	10	600	60	0.5	1		—
20	RFUH60TS6D	G	—	C11	600	600	60	120	2.8	30	10	600	35	0.5	1		—
21	RF301BM2S	*	FH	TL	200	200	3	40	0.93	3	10	200	25	0.5	1	TO-252 (DPAK)	YES
22	RFN3BM2S		FH	TL	200	200	3	40	0.98	3	10	200	25	0.5	1		YES
23	RF501BM2S		FH	TL	200	200	5	40	0.92	5	1	200	25	0.5	1		YES
24	RFN5BM2S		FH	TL	200	200	5	40	0.98	5	10	200	25	0.5	1		YES
25	RFN5BM3S		FH	TL	350	350	5	50	1.5	5	10	350	30	0.5	1		YES
26	RFN3BM6S		FH	TL	600	600	3	20	1.55	3	10	600	30	0.5	1		YES
27	RF305BM6S		FH	TL	600	600	3	50	1.7	3	10	600	30	0.5	1		YES
28	RFNL5BM6S		FH	TL	600	600	5	50	1.3	5	10	600	60	0.5	1		YES
29	RFN5BM6S		FH	TL	600	600	5	30	1.55	5	10	600	50	0.5	1		YES
30	RF505BM6S		FH	TL	600	600	5	50	1.7	5	10	600	30	0.5	1		YES
31	RFV5BM6S		FH	TL	600	600	5	60	2.8	5	10	600	20	0.5	1		YES
32	RFV8BM6S		FH	TL	600	600	8	100	2.8	8	10	600	25	0.5	1		YES
33	RFN10BM3S	*	FH	TL	350	350	10	80	1.5	10	10	350	30	0.5	1	TO-252 (DPAK)	YES
34	RFN10BM6S		FH	TL	600	600	10	100	1.55	10	10	600	50	0.5	1		YES
35	RFN10NS3S		FH	TL	350	350	10	100	1.5	10	10	350	30	0.5	1		YES
36	RFN20NS3S		FH	TL	350	350	20	100	1.35	20	10	350	35	0.5	1		YES
37	RFUH25NS3S		FH	TL	350	350	20	100	1.45	20	10	350	30	0.5	1		YES
38	RFUH20NS3S		FH	TL	350	350	20	100	1.5	20	10	350	25	0.5	1		YES
39	RFN10NS4S		FH	TL	430	430	10	80	1.55	10	10	430	30	0.5	1		YES
40	RFUH10NS4S		FH	TL	430	430	10	80	1.7	10	10	430	25	0.5	1		YES
41	RFN20NS4S		FH	TL	430	430	20	100	1.55	20	10	430	30	0.5	1		YES
42	RFUH20NS4S		FH	TL	430	430	20	100	1.7	20	10	430	25	0.5	1		YES
43	RFN10NS6S		FH	TL	600	600	10	100	1.55	10	10	600	50	0.5	1		YES
44	RFUH10NS6S		FH	TL	600	600	10	60	2.8	10	10	600	25	0.5	1		YES
45	RFN20NS6S		FH	TL	600	600	20	100	1.55	20	10	600	60	0.5	1		YES
46	RFUH20NS6S		FH	TL	600	600	20	100	2.8	20	10	600	35	0.5	1		YES
47	RFN30TS6S		G	—	C11	600	600	30	200	1.55	30	10	600	60	0.5		1
48	RFUH30TS6S	G	—	C11	600	600	30	150	2.8	30	10	600	35	0.5	1	—	

*General part No. have no grade code.

*1 : I_O : Average rectified output current die. In case of 2 dies , I_O indicates average output current of 2 chips. *2 : Value/Chip Package is JEDEC code. () : ROHM Packages

Fast Recovery Diodes

Example: R F U H 2 5 T B 3 S H Z C 9
Part No. Grade Code Taping Code

Fast Recovery Diodes

Power Fast Recovery Diodes 2																		
Quick Reference No.	Product No.				Absolute Maximum Ratings(Tc=25°C)				Electrical Characteristics(Tj=25°C)							Package	Equivalent Circuit Diagram	Automotive Grade AEC-Q101
	Part No.	Grade Code		Taping Code	V _{RM} (V)	V _R (V)	I _O (A)	I _{FSM} (A) 60Hz, 1ms	V _F (V) Max.	I _F (A)	I _R (μA) Max.	V _R (V)	t _{rr} (ns)/Max.	I _F (A)	I _R (A)			
	General	Automotive																
49	RFUH25TB3S	NZ	HZ	C9	350	350	20	100	1.45	20	10	350	30	0.5	1	TO-220FN <2pin>		YES
50	RFUH20TB3S	NZ	HZ	C9	350	350	20	100	1.5	20	10	350	25	0.5	1			YES
51	RFN10TB4S	NZ	HZ	C9	430	430	10	80	1.55	10	10	430	30	0.5	1			YES
52	RFUH10TB4S	NZ	HZ	C9	430	430	10	80	1.7	10	10	430	25	0.5	1			YES
53	RFN20TB4S	NZ	HZ	C9	430	430	20	100	1.55	20	10	430	30	0.5	1			YES
54	RFUH20TB4S	NZ	HZ	C9	430	430	20	100	1.7	20	10	430	25	0.5	1			YES
55	RF1501TF3S	*	FH	C9	350	300	20	100	1.5	20	10	300	30	0.5	1	TO-220NFM <2pin>		YES
56	RFN5TF6S		FH	C9	600	600	5	30	1.55	5	10	600	50	0.5	1			YES
57	RF505TF6S		FH	C9	600	600	5	80	1.7	5	10	600	30	0.5	1			YES
58	RFUH5TF6S		FH	C9	600	600	5	30	2.8	5	10	600	25	0.5	1			YES
59	RFN10TF6S		FH	C9	600	600	10	100	1.55	10	10	600	50	0.5	1			YES
60	RF1005TF6S		FH	C9	600	600	10	100	1.7	10	10	600	40	0.5	1			YES
61	RFUH10TF6S		FH	C9	600	600	10	60	2.8	10	10	600	25	0.5	1			YES
62	RFN20TF6S		FH	C9	600	600	20	100	1.55	20	10	600	60	0.5	1			YES
63	RFUH20TF6S		FH	C9	600	600	20	100	2.8	20	10	600	35	0.5	1			YES
64	RFN5TF8S		FH	C9	800	800	5	60	2.1	5	10	800	40	0.5	1			YES
65	RFNL5TJ6S	G	FHG	C9	600	600	5	50	1.3	5	10	600	60	0.5	1	TO-220ACFP		YES
66	RFV8TJ6S	G	—	C9	600	600	8	100	2.8	8	10	600	25	0.5	1			—
67	RFV58TJ6S	G	—	C9	600	600	8	60	3	8	10	600	20	0.5	1			—
68	RFNL10TJ6S	G	FHG	C9	600	600	10	120	1.25	8	10	600	65	0.5	1			YES
									1.3	10								
69	RFV12TJ6S	G	—	C9	600	600	12	120	2.8	12	10	600	25	0.5	1			—
70	RFNL15TJ6S	G	FHG	C9	600	600	15	160	1.3	15	10	600	65	0.5	1			YES
71	RFV15TJ6S	G	—	C9	600	600	15	150	2.8	15	10	600	30	0.5	1			—
72	RFNL20TJ6S	G	FHG	C9	600	600	20	200	1.3	20	10	600	70	0.5	1			YES
73	RFN20TJ6S	G	FHG	C9	600	600	20	150	1.55	20	10	600	60	0.5	1			YES
74	RFUH20TJ6S	G	FHG	C9	600	600	20	120	2.8	20	10	600	35	0.5	1	YES		
75	RFV8TG6S	G	—	C9	600	600	8	100	2.8	8	10	600	25	0.5	1	TO-220AC		—
76	RFV58TG6S	G	—	C9	600	600	8	60	3	8	10	600	20	0.5	1			—
77	RFV12TG6S	G	—	C9	600	600	12	120	2.8	12	10	600	25	0.5	1			—
78	RFV15TG6S	G	—	C9	600	600	15	150	2.8	15	10	600	30	0.5	1			—
79	RFV30TG6S	G	—	C9	600	600	30	200	2.8	30	10	600	40	0.5	1			—

*General part No. have no grade code.
Package is JEDEC code. (): ROHM Packages

Rectifier Diodes

Example: **RR1VWM4S** **TF** **TR**
 Part No. Grade Code Taping Code

Rectifier Diodes

Quick Reference for Rectifier Diodes

	V _{RM} (V)	I _O (A)	Surface Mount type							Leaded type									
			2513 Size (PMDE)	2514 Size (TUMD2SM)	3516 Size SOD-123FL (PMDU)	4725 Size SOD-128 (PMDTM)	2928 Size SOT-25T (TSMD5)	TO-252 (DPAK)	TO-220ACFP										
General Purpose Rectifier Diodes	400	0.2		RRE02VSM4S RRE02VTM4S	3 4														
		0.4							RRE04EA4D	18									
		0.7		RRE07VSM4S RRE07VTM4S	5 6	RRD07MM4S RR264MM-400	11 12												
		1	RR1VWM4S	1				RR1LAM4S	14	RR274EA-400	19								
		2						RR2LAM4S	15										
	600	0.2		RRE02VSM6S RRE02VTM6S	7 8														
		0.4								RRE04EA6D	20								
		0.7		RRE07VSM6S RRE07VTM6S	9 10														
		1	RR1VWM6S	2		RR268MM-600	13	RR1LAM6S	16										
		2						RR2LAM6S	17										
High-Speed Rectifier Diodes	400	1						RRU1LAM4S	21										
Power Rectifier Diodes	400	6															RR601BM4S	22	
	1000	20																RRD20TJ10S	23

Package is JEDEC code. () : ROHM Packages

General Purpose Rectifier Diodes																		
Quick Reference No.	Product No.				Absolute Maximum Ratings (T _c =25°C or T _I =25°C)				Electrical Characteristics (T _j =25°C)*2						Package	Equivalent Circuit Diagram	Automotive Grade AEC-Q101	
	Part No.	Grade Code General	Grade Code Automotive	Taping Code	V _{RM} (V)	V _R (V)	I _O *1 (A)	I _{FSM} (A) 60Hz, 1% _~	V _F (V) Max.	I _F (A)	I _n (μA) Max.	V _R (V)	t _{rr} (ns)/Max.	I _F (mA)				I _R (mA)
1	RR1VWM4S	*	TF	TR	400	400	1	15	1.2	1	10	400	—	—	—	(PMDE)		YES
2	RR1VWM6S	*	TF	TR	600	600	1	15	1.2	1	10	600	—	—	—			YES
3	RRE02VSM4S	—	—	TR	400	400	0.2	1	1.1	0.2	1	400	—	—	—	(TUMD2SM)		—
4	RRE02VTM4S	—	FH	TR	400	400	0.2	1	1.1	0.2	1	400	—	—	—			YES
5	RRE07VSM4S	*	—	TR	400	400	0.7	2	1.1	0.7	1	400	—	—	—			—
6	RRE07VTM4S	—	FH	TR	400	400	0.7	2	1.1	0.7	1	400	—	—	—			YES
7	RRE02VSM6S	*	—	TR	600	600	0.2	1	1.1	0.2	1	600	—	—	—			—
8	RRE02VTM6S	—	FH	TR	600	600	0.2	1	1.1	0.2	1	600	—	—	—			YES
9	RRE07VSM6S	*	—	TR	600	600	0.7	2	1.1	0.7	1	600	—	—	—			—
10	RRE07VTM6S	—	FH	TR	600	600	0.7	2	1.1	0.7	1	600	—	—	—			YES
11	RRD07MM4S	—	—	TR	400	400	0.7	150*3	0.98	0.7	1	400	—	—	—	SOD-123FL (PMDU)	—	
12	RR264MM-400	—	TF	TR	400	400	0.7	25	1.1	0.7	10	400	—	—	—		YES	
13	RR268MM-600	—	TF	TR	600	400	1	25	0.98	1	10	400	—	—	—	YES		
14	RR1LAM4S	—	TF	TR	500	400	1	30	1.1	1	10	400	—	—	—	SOD-128 (PMDTM)	YES	
15	RR2LAM4S	*	TF	TR	400	400	2	50	1.1	2	10	400	—	—	—		YES	
16	RR1LAM6S	—	TF	TR	750	600	1	30	1.1	1	10	600	—	—	—		YES	
17	RR2LAM6S	—	TF	TR	600	600	2	50	1.1	2	10	600	—	—	—	YES		
18	RRE04EA4D	—	FH	TR	400	400	0.4	2	1.1	0.2	1	400	—	—	—	SOT-25T (TSMD5)	YES	
19	RR274EA-400	—	FH	TR	400	400	1	8	1.1	0.5	10	400	—	—	—		YES	
20	RRE04EA6D	—	FH	TR	600	600	0.4	2	1.1	0.2	1	600	—	—	—		YES	
High-Speed Rectifier Diode																		
21	RRU1LAM4S	*	TF	TR	500	400	1	20	1.3	0.8	10	400	400	10	10	SOD-128 (PMDTM)		YES
Power Rectifier Diodes																		
22	RR601BM4S	*	FH	TL	400	400	6	40	1.1	6	10	400	—	—	—	TO-252 (DPAK)		YES
23	RRD20TJ10S	G	—	C9	1,000	1,000	20	200	1.05	20	10	1,000	—	—	—	TO-220ACFP		—

*General part No. have no grade code.

*1 : I_O : Average output current per chip. In case of 2 chip diodes, I_O indicates average output current of 2 chips. *2 : Value/Chip *3 I_{FSM}(guaranteed) : charged waveform t=500us(1/2peak), 1pulse/4s, R_{th}<80°C/W

Package is JEDEC code.() : ROHM Packages.

Zener Diodes
 Example: **Y F Z V** **F H** **TR** **2 . 0** **B**
 Part No. Grade Code Taping Code Zener Voltage Sub Division

Zener Diodes 2																			
Package	Surface Mount type																		
	2514 Size (TUMD2M)	2513 Size (TUMD2M)	2514 Size (TUMD2M)	3516 Size SOD-123FL(PMDU)	2120 Size SOT-343(UMD4)														
Equivalent Circuit Diagram																			
Series Name	YFZV Series			New TDZV Series			New YDZV Series			KDZV Series			UMZK Series						
Automotive Grade Code	FH			—			FH			TF			FH						
Power(mW)	500			500			500			1,000			200						
Taping Code	TR			TR			TR			TR			TL						
Electrical Characteristics (Ta=25°C)	Vz (V)	Iz (mA)	Automotive Grade AEC-Q101	Vz (V)	Iz (mA)	Automotive Grade AEC-Q101	Vz (V)	Iz (mA)	Automotive Grade AEC-Q101	Vz (V)	Iz (mA)	Automotive Grade AEC-Q101	Vz (V)	Iz (mA)	Automotive Grade AEC-Q101				
	2.0B	2.02 to 2.20	20	YES	—	—	—	—	—	—	2.0B	2.00 to 2.24	40	YES	—	—			
2.2B	2.22 to 2.41	20	YES	—	—	—	—	—	—	2.2B	2.20 to 2.45	40	YES	—	—				
2.4B	2.43 to 2.63	20	YES	—	—	—	—	—	—	2.4B	2.40 to 2.70	40	YES	—	—				
2.7B	2.69 to 2.91	20	YES	—	—	—	—	—	—	2.7B	2.70 to 3.10	40	YES	—	—				
3.0B	3.01 to 3.22	20	YES	—	—	—	—	—	—	3.0B	3.00 to 3.40	40	YES	—	—				
3.3B	3.32 to 3.53	20	YES	—	—	—	—	—	—	3.3B	3.30 to 3.70	40	YES	—	—				
3.6B	3.600 to 3.845	20	YES	—	—	—	—	—	—	3.6B	3.60 to 4.00	40	YES	3.6K	3.600 to 3.845	5	YES		
3.9B	3.89 to 4.16	20	YES	—	—	—	—	—	—	3.9B	3.90 to 4.40	40	YES	3.9K	3.89 to 4.16	5	YES		
4.3B	4.17 to 4.43	20	YES	—	—	—	—	—	—	4.3B	4.30 to 4.80	40	YES	4.3K	4.17 to 4.43	5	YES		
4.7B	4.55 to 4.80	20	YES	—	—	—	—	—	—	4.7B	4.70 to 5.20	40	YES	4.7K	4.55 to 4.75	5	YES		
5.1B	4.94 to 5.20	20	YES	5.1	4.60 to 5.60	10	—	5.1	4.60 to 5.60	10	YES	5.1B	5.10 to 5.70	40	YES	5.1K	4.98 to 5.20	5	YES
5.6B	5.45 to 5.73	20	YES	5.6	5.10 to 6.10	10	—	5.6	5.10 to 6.10	10	YES	5.6B	5.60 to 6.30	40	YES	5.6K	5.49 to 5.73	5	YES
6.2B	5.96 to 6.27	20	YES	6.2	5.60 to 6.80	10	—	6.2	5.60 to 6.80	10	YES	6.2B	6.20 to 7.00	40	YES	6.2K	6.06 to 6.33	5	YES
6.8B	6.49 to 6.83	20	YES	6.8	6.20 to 7.40	10	—	6.8	6.20 to 7.40	10	YES	6.8B	6.80 to 7.70	40	YES	6.8K	6.65 to 6.93	5	YES
7.5B	7.07 to 7.45	20	YES	7.5	6.80 to 8.30	10	—	7.5	6.80 to 8.30	10	YES	7.5B	7.50 to 8.40	40	YES	7.5K	7.28 to 7.60	5	YES
8.2B	7.78 to 8.19	20	YES	8.2	7.40 to 9.00	10	—	8.2	7.40 to 9.00	10	YES	8.2B	8.20 to 9.30	40	YES	8.2K	8.02 to 8.36	5	YES
9.1B	8.57 to 9.01	20	YES	9.1	8.20 to 10.00	10	—	9.1	8.20 to 10.00	10	YES	9.1B	9.10 to 10.20	40	YES	9.1K	8.85 to 9.23	5	YES
10B	9.41 to 9.90	20	YES	10	9.00 to 11.00	10	—	10	9.00 to 11.00	10	YES	10B	10.00 to 11.20	40	YES	10K	9.77 to 10.21	5	YES
11B	10.50 to 11.05	10	YES	11	9.90 to 12.10	10	—	11	9.90 to 12.10	10	YES	11B	11.00 to 12.30	20	YES	11K	10.76 to 11.22	5	YES
12B	11.44 to 12.03	10	YES	12	10.80 to 13.20	10	—	12	10.80 to 13.20	10	YES	12B	12.00 to 13.50	20	YES	12K	11.74 to 12.24	5	YES
13B	12.55 to 13.21	10	YES	13	11.70 to 14.30	10	—	13	11.70 to 14.30	10	YES	13B	13.30 to 15.00	20	YES	13K	12.91 to 13.49	5	YES
15B	13.89 to 14.62	10	YES	15	13.50 to 16.50	10	—	15	13.50 to 16.50	10	YES	15B	14.70 to 16.50	20	YES	15K	14.34 to 14.98	5	YES
16B	15.25 to 16.04	10	YES	16	14.40 to 17.60	10	—	16	14.40 to 17.60	10	YES	16B	16.20 to 18.30	20	YES	16K	15.85 to 16.51	5	YES
18B	16.82 to 17.70	10	YES	18	16.20 to 19.80	10	—	18	16.20 to 19.80	10	YES	18B	18.00 to 20.30	20	YES	18K	17.56 to 18.35	5	YES
20B	18.63 to 19.59	10	YES	20	18.00 to 22.00	10	—	20	18.00 to 22.00	10	YES	20B	20.00 to 22.40	20	YES	20K	19.52 to 20.39	5	YES
22B	20.64 to 21.71	5	YES	22	19.80 to 24.20	10	—	22	19.80 to 24.20	10	YES	22B	22.00 to 24.50	10	YES	22K	21.54 to 22.47	5	YES
24B	22.61 to 23.77	5	YES	24	21.60 to 26.40	10	—	24	21.60 to 26.40	10	YES	24B	24.00 to 27.60	10	YES	24K	23.72 to 24.78	5	YES
27B	24.97 to 26.26	5	YES	27	24.30 to 29.70	10	—	27	24.30 to 29.70	10	YES	27B	27.00 to 30.80	10	YES	27K	26.19 to 27.53	5	YES
30B	27.70 to 29.13	5	YES	30	27.00 to 33.00	10	—	30	27.00 to 33.00	10	YES	30B	30.00 to 34.00	10	YES	30K	29.19 to 30.69	5	YES
33B	30.32 to 31.88	5	YES	—	—	—	—	—	—	33B	33.00 to 37.00	10	YES	33K	32.15 to 33.79	5	YES		
36B	32.79 to 34.49	5	YES	—	—	—	—	—	—	36B	36.00 to 40.00	10	YES	36K	35.07 to 36.87	5	YES		
39B	35.36 to 37.19	5	YES	—	—	—	—	—	—	—	—	—	—	—	—	—			

Zener Diodes 2																			
Package	Surface Mount type																		
	2512 Size SOD-323FL(UMD2)	2924 Size SOT-23(SSD3)	2924 Size SOT-23(SSD3)	3516 Size SOD-123FL(PMDU)	4725 Size SOD-128(PMDTM)														
Equivalent Circuit Diagram																			
Series Name	UDZLV Series			New BZX84B Series			BZX84C Series			KDZLV Series			New PDZVB Series						
Automotive Grade Code	FH			FH			FH			TF			TF						
Power(mW)	200			250			250			1,000			1,000						
Taping Code	TE-17			T116			T116			TR			TR						
Electrical Characteristics (Ta=25°C)	Vz (V)	Iz (mA)	Automotive Grade AEC-Q101	Vz (V)	Iz (mA)	Automotive Grade AEC-Q101	Vz (V)	Iz (mA)	Automotive Grade AEC-Q101	Vz (V)	Iz (mA)	Automotive Grade AEC-Q101	Vz (V)	Iz (mA)	Automotive Grade AEC-Q101				
	51	48 to 54	2	YES	—	—	—	2V4L	2.2 to 2.6	5	YES	51	48 to 54	2	YES	2.0B	2.00 to 2.24	40	YES
56	53 to 60	2	YES	—	—	—	2V7L	2.5 to 2.9	5	YES	56	53 to 60	2	YES	2.2B	2.20 to 2.45	40	YES	
62	58 to 66	2	YES	—	—	—	3V0L	2.8 to 3.2	5	YES	62	58 to 66	2	YES	2.4B	2.40 to 2.70	40	YES	
68	64 to 72	2	YES	—	—	—	3V3L	3.1 to 3.5	5	YES	68	64 to 72	2	YES	2.7B	2.70 to 3.10	40	YES	
75	70 to 79	2	YES	—	—	—	3V6L	3.4 to 3.8	5	YES	75	70 to 79	2	YES	3.0B	3.00 to 3.40	40	YES	
82	77 to 87	2	YES	—	—	—	3V9L	3.7 to 4.1	5	YES	82	77 to 87	2	YES	3.3B	3.30 to 3.70	40	YES	
91	85 to 96	1	YES	—	—	—	4V3L	4.0 to 4.6	5	YES	91	85 to 96	2	YES	3.6B	3.60 to 4.00	40	YES	
100	94 to 106	1	YES	—	—	—	4V7L	4.4 to 5.0	5	YES	100	94 to 106	2	YES	3.9B	3.90 to 4.40	40	YES	
110	104 to 116	1	YES	5V1L	5.00 to 5.20	5	YES	5V1L	4.8 to 5.4	5	YES	110	104 to 116	2	YES	4.3B	4.30 to 4.80	40	YES
120	114 to 126	1	YES	5V6L	5.49 to 5.71	5	YES	5V6L	5.2 to 6.0	5	YES	120	114 to 126	2	YES	4.7B	4.70 to 5.20	40	YES
130	122 to 138	1	YES	6V2L	6.08 to 6.32	5	YES	6V2L	5.8 to 6.6	5	YES	130	122 to 138	2	YES	5.1B	5.10 to 5.70	40	YES
150	140 to 160	1	YES	6V8L	6.66 to 6.94	5	YES	6V8L	6.4 to 7.2	5	YES	150	140 to 160	2	YES	5.6B	5.60 to 6.30	40	YES
—	—	—	—	7V5L	7.35 to 7.65	5	YES	7V5L	7.0 to 7.9	5	YES	—	—	—	—	6.2B	6.20 to 7.00	40	YES
—	—	—	—	8V2L	8.04 to 8.36	5	YES	8V2L	7.7 to 8.7	5	YES	—	—	—	—	6.8B	6.80 to 7.70	40	YES
—	—	—	—	9V1L	8.92 to 9.28	5	YES	9V1L	8.5 to 9.6	5	YES	—	—	—	—	7.5B	7.50 to 8.40	40	YES
—	—	—	—	10V1L	9.80 to 10.20	5	YES	10V1L	9.4 to 10.6	5	YES	—	—	—	—	8.2B	8.20 to 9.30	40	YES
—	—	—	—	11V1L	10.80 to 11.20	5	YES	11V1L	10.4 to 11.6	5	YES	—	—	—	—	9.1B	9.10 to 10.20	40	YES
—	—	—	—	12V1L	11.80 to 12.20	5	YES	12V1L	11.4 to 12.7	5	YES	—	—	—	—	10B	10.00 to 11.20	40	YES
—	—	—	—	13V1L	12.70 to 13.30	5	YES	13V1L	12.4 to 14.1	5	YES	—	—	—	—	11B	11.00 to 12.30	20	YES
—	—	—	—	15V1L	14.70 to 15.30	5	YES	15V1L	13.8 to 15.6	5	YES	—	—	—	—	12B	12.00 to 13.50	20	YES
—	—	—	—	16V1L	15.70 to 16.30	5	YES	16V1L	15.3 to 17.1	5	YES	—	—	—	—	13B	13.30 to 15.00	20	YES
—	—	—	—	18V1L	17.60 to 18.40	5	YES	18V1L	16.8 to 19.1	5	YES	—	—	—	—	15B	14.70 to 16.50	20	YES
—	—	—	—	20V1L	19.60 to 20.40	5	YES	20V1L	18.8 to 21.2	5	YES	—	—	—	—	16B	16.20 to 18.30	20	YES
—	—	—	—	22V1L	21.60 to 22.40	5	YES	22V1L	20.8 to 23.3	5	YES	—	—	—	—	18B	18.00 to 20.30	20	YES
—	—	—	—	24V1L	23.50 to 24.50	5	YES	24V1L	22.8 to 25.6	5	YES	—	—	—	—	20B	20.00 to 22.40	20	YES
—	—	—	—	27V1L	26.50 to 27.50	2	YES	27V1L	25.1 to 28.9	2	YES	—	—	—	—	22B	22.00 to 24.50	10	YES
—	—	—	—	30V1L	29.40 to 30.60	2	YES	30V1L	28.0 to 32.0	2	YES	—	—	—	—	24B	24.00 to 27.60	10	YES
—	—	—	—	33V1L	32.30 to 33.70	2	YES	33V1L	31.0 to 35.0	2	YES	—	—	—	—	27B	27.00 to 30.80	10	YES
—	—	—	—	36V1L	35.30 to 36.70	2	YES	36V1L	34.0 to 38.0	2	YES	—	—	—	—	30B	30.00 to 34.00	10	YES
—	—	—	—	—	—	—	—	—	—	—	—	—	—	—	33B	33.00 to 37.00	10	YES	
—	—	—	—	—	—	—	—	—	—	—	—	—	—	—	36B	36.00 to 40.00	10	YES	

Note : This table shows available voltages.
 Package is JEDEC code. () : ROHM Packages

Zener Diodes as ESD Protection

● Quick Reference for Protection Devices [2-4 Elements]

Vz (V)	Package							
	1212 Size	1616 Size			2120 Size		2928 Size	
	SOT-723 (VMD3)	SOT-416 (EMD3)	SOT-553 (EMD5)	SOT-323 (UMD3)	SOT-323FL (UMD3F)	SOT-353 (UMD5)	SOT-346 (SMD3)	SOT-25 (SMD5)
4.3								FTZ4.3E
5.1					New UMZ5.1NUM			
5.6							STZ5.6N	FTZ5.6E
6.2							STZ6.2N	
6.8	VMZ6.8N	EMZ6.8N	EMZ6.8E	UMZ6.8N		UMZ6.8EN	STZ6.8T STZ6.8N	FTZ6.8E
8.2					New UMZ8.2NUM			
12					New UMZ12NUM			
16					New UMZ16NUM			
18					New UMZ18NUM			
27					New UMZ27NUM			
30					New UMZ30NUM			FTZ30E
36					New UMZ36NUM			

Package is JEDEC code. (): ROHM Packages.

● Quick Reference for Low Capacitance Protection Devices

Vz (V)	Package					
	1006 Size		1608 Size	1616 Size		2928 Size
	SOD-923 (VMN2)	SOD-923 (VMN2M)	SOD-523 (EMD2)	SOT-553 (EMD5)	SOT-563 (EMD6)	SOT-25 (SMD5)
5.1		CDZCV5.1B				
6.2						FTZU6.2E
6.8	CDZC6.8B	New CDZCV6.8B New RSAC6.8CM	EDZCV6.8B	EMZT6.8E		
12					RSB12JS2	
16		New RSAC16CM				
18	RSAC18CS					

Package is JEDEC code. (): ROHM Packages.

● Quick Reference for ESD Protection Devices

Vz (V)	Package		
	1616 Size	2120 Size	2928 Size
	SOT-553 (EMD5)	SOT-353 (UMD5)	SOT-457 (SMD6)
6	RSA6.1J4	RSA6.1EN	RSA6.1U5

Package is JEDEC code. (): ROHM Packages.

● Quick Reference for Bi-Directional Zener Diodes

Vz (V)	Package									
	0603 Size	1006 Size		1608 Size	1616 Size	2512 Size	2513 Size	2120 Size		
							(TUMD2)			
	SOD-962 (GMD2)	SOD-923 (VMN2)	SOD-923 (VMN2M)	SOD-523 (EMD2)	SOT-416FL (EMD3F)	SOD-323FL (UMD2)		SOT-323 (UMD3)	SOT-323FL (UMD3F)	SOT-363 (UMD6)
4.0										
5.6				RSB5.6SM						
6.8	RSB6.8ZS	RSB6.8CS	RSB6.8CM	RSB6.8SM				RSB6.8F2		
12					New RSB12WM	RSB12V				
16						RSB16V	RSB16VA	RSB16F2		RSB16X3N
18						RSB18V	RSB18VA		New RSB18UM2	
27						RSB27V	RSB27VA		RSB27UM2	
33						RSB33V		RSB33F2		
36						RSB36V		RSB36F2		
39						RSB39V		RSB39F2		

Package is JEDEC code. (): ROHM Packages.

● Quick Reference for Ultra Low Capacitance Bi-Directional Zener Diodes

Vz (V)	Package	
	1006 Size	
	SOD-923 (VMN2)	SOD-923 (VMN2M)
6.8	RSBC6.8CS	New RSBC6.8CM

Package is JEDEC code. (): ROHM Packages.

Zener Diodes as ESD Protection

Zener Diodes as ESD Protection

Example:

F	T	Z	U	6	.	2	E	F	H	T	1	4	8	
				Part No.					Grade Code	Taping Code				

Protection Devices [2-4 Elements]											
Product No.			Absolute Maximum Ratings(Ta=25°C)	Electrical Characteristics(Ta=25°C)*2			Remarks	Package	Equivalent Circuit Diagram	Automotive Grade AEC-Q101	
Part No.	Grade Code			P _D (mW)	V _Z (V)	I _Z (mA)					
	General	Automotive									
STZ6.8T			T146	200	6.47 to 7.14	5	IEC61000-4-2 150pF, 330Ω Contact 8kV Air 15kV	SOT-346 (SMD3)		YES	
VMZ6.8N		FH	T2L	150	6.47 to 7.14	5		SOT-723 (VMD3)		YES	
EMZ6.8N		FH	TL	150	6.47 to 7.14	5		SOT-416 (EMD3)		YES	
UMZ6.8N		FH	T106	200	6.47 to 7.14	5		SOT-323 (UMD3)		YES	
New UMZ5.1NUM		FH	TL	200	4.84 to 5.37	5		SOT-323FL (UMD3F)		YES	
New UMZ8.2NUM		FH	TL	200	7.76 to 8.64	5				YES	
New UMZ12NUM		FH	TL	200	11.00 to 13.00	5				YES	
New UMZ16NUM		FH	TL	200	15.85 to 16.51	5				YES	
New UMZ18NUM		FH	TL	200	17.56 to 18.53	5				YES	
New UMZ27NUM	*	FH	TL	200	26.19 to 27.35	5				YES	
New UMZ30NUM		FH	TL	200	29.19 to 30.69	5				YES	
New UMZ36NUM		FH	TL	200	35.07 to 36.87	5				YES	
STZ5.6N		FH	T146	200	5.31 to 5.92	5			SOT-346 (SMD3)	YES	
STZ6.2N		FH	T146	200	5.81 to 6.40	5			YES		
STZ6.8N		FH	T146	200	6.47 to 7.14	5		YES			
EMZ6.8E		FH	T2R	150	6.47 to 7.14	5		SOT-553 (EMD5)		YES	
UMZ6.8EN		FH	TR	200	6.47 to 7.14	5		SOT-353 (UMD5)		YES	
FTZ4.3E		FH	T148	200	4.04 to 4.57	5		SOT-25 (SMD5)		YES	
FTZ5.6E		FH	T148	200	5.31 to 5.92	5				YES	
FTZ6.8E		FH	T148	200	6.47 to 7.14	5				YES	
FTZ30E		FH	T148	200	29.19 to 30.09	5				YES	

*General part No. have no grade code.
Package is JEDEC code. (): ROHM Packages

Low Capacitance Protection Devices												
Product No.			Absolute Maximum Ratings(Ta=25°C)	Electrical Characteristics(Ta=25°C)						Package	Equivalent Circuit Diagram	Automotive Grade AEC-Q101
Part No.	Grade Code			P _D (mW)	V _Z (V)	I _Z (mA)	C _t (pF) (Typ.)	f(MHz)	V _R (V)			
	General	Automotive										
FTZU6.2E		FH	T148	200	5.90 to 6.50	5	8	1	0	SOT-25(SMD5)		YES
CDZC6.8B		FH	T2RA	100	6.65 to 6.93	5	3	1	0	SOD-923 (VMN2)		YES
CDZCV5.1B		—	T2R	100	4.98 to 5.20	5	5.5	1	0	SOD-923 (VMN2M)		—
New CDZCV6.8B		—	T2R	100	6.65 to 6.93	5	3	1	0	SOD-523 (EMD2)		—
EDZCV6.8B		FH	T2R	150	6.65 to 6.93	5	3	1	0	SOD-523 (EMD2)		YES
EMZT6.8E		FH	T2R	150	6.47 to 7.14	5	7	1	0	SOT-553 (EMD5)		YES
RSB12JS2		FH	T2R	150	9.60 to 14.40	5	1	1	0	SOT-563 (EMD6)		YES
New RSAC16CM		—	T2R	100	16.49 to 17.51	5	0.3	1	0	SOD-923 (VMN2M)		—
RSAC18CS		—	T2RA	100	18.20 to 19.35	5	0.3	1	0	SOD-923 (VMN2)		—
New RSAC6.8CM		—	T2R	100	6.70 to 7.33	5	0.3	1	0	SOD-923 (VMN2M)		—

*General part No. have no grade code.
*1 : (3), (6) pin must be open when using.
Package is JEDEC code. (): ROHM Packages

ESD Protection Devices											
Product No.			Absolute Maximum Ratings(Ta=25°C)	Electrical Characteristics(Ta=25°C)			Peak Pulse Power(W) (tp=10×100μs)	Package	Equivalent Circuit Diagram	Automotive Grade AEC-Q101	
Part No.	Grade Code			P _D (mW)	V _Z (V)	I _Z (mA)					
	General	Automotive									
RSA6.1J4		FH	T2R	150	6.10 to 7.20	1	10	SOT-553 (EMD5)		YES	
RSA6.1EN		FH	TR	200	6.10 to 7.20	1	30	SOT-353 (UMD5)		YES	
RSA6.1U5		FH	T108	200	6.10 to 7.20	1	30	SOT-457 (SMD6)		YES	

*General part No. have no grade code.
Package is JEDEC code. (): ROHM Packages

Zener Diodes as ESD Protection

Example: **R S B C 6 . 8 C S F H T 2 R A**
Part No. Grade Code Taping Code

Zener Diodes as ESD Protection

Bi-Directional Zener Diodes													
Product No.			Absolute Maximum Ratings (Ta=25°C)		Electrical Characteristics (Ta=25°C)		Peak Pulse Power (W) (tp=10×1000µs)			Remarks	Package	Equivalent Circuit Diagram	Automotive Grade AEC-Q101
Part No.	Grade Code		Po (mW)	Vz (V)	Iz (mA)	Ct (pF) (Typ.)	f (MHz)	Vr (V)					
	General	Automotive	Taping Code										
RSB6.8ZS	—	—	T2N	100	5.78 to 7.82	1	—	—	—	IEC61000-4-2 150pF, 330Ω Contact 8kV Air 15kV	SOD-962 (GMD2)	—	
RSB6.8CS	—	FH	T2RA	100	5.78 to 7.82	1	10	15	1		0	SOD-923 (VMN2)	YES
RSB6.8CM	—	—	T2N	100	5.78 to 7.82	1	10	15	1		0	SOD-923 (VMN2M)	—
RSB5.6SM	—	—	T2N	150	4.76 to 6.44	1	10	50	1		0	SOD-523 (EMD2)	—
RSB6.8SM	—	—	T2N	150	5.78 to 7.82	1	10	30	1		0		—
RSB12V	—	FH	TE-17	200	10.8 to 13.2	1	—	30	1		0	SOD-323FL (UMD2)	YES
RSB16V	—	FH	TE-17	200	14.4 to 17.6	1	—	30	1		0		YES
RSB18V	—	FH	TE-17	200	16.2 to 19.8	1	—	30	1		0		YES
RSB27V	—	FH	TE-17	200	26.2 to 32.0	1	—	30	1		0		YES
RSB33V	—	FH	TE-17	200	29.7 to 36.3	1	—	30	1		0		YES
RSB36V	—	FH	TE-17	200	32.4 to 39.6	1	—	30	1		0		YES
RSB39V	—	FH	TE-17	200	35.1 to 42.9	1	—	30	1		0		YES
RSB16VA	*	FH	TR	500	14.4 to 17.6	1	—	—	—		—		YES
RSB18VA	*	FH	TR	500	16.2 to 19.8	1	—	—	—		—		YES
RSB27VA	*	FH	TR	500	26.2 to 32.0	1	—	—	—		—		YES
RSB6.8F2	—	FH	T106	200	5.78 to 7.82	1	—	30	1		0	SOT-323 (UMD3)	YES
RSB16F2	—	FH	T106	200	14.4 to 17.6	1	—	30	1		0		YES
RSB33F2	—	FH	T106	200	29.7 to 36.3	1	—	30	1		0		YES
RSB36F2	—	FH	T106	200	32.4 to 39.6	1	—	30	1		0		YES
RSB39F2	—	FH	T106	200	35.1 to 42.9	1	—	30	1		0		YES
New RSB18UM2	—	FH	TL	200	16.2 to 19.8	1	—	30	1	0	SOT-323FL (UMD3F)		YES
RSB27UM2	—	FH	TL	200	26.2 to 32.0	1	—	30	1	0	YES		
RSB16X3N	—	FH	TR	200	14.4 to 17.6	1	—	30	1	0	SOT-363 (UMD6)		YES
New RSB12WM	—	FH	TL	150	9.60 to 14.40	5	—	1	1	0	SOT-416FL (EMD3F)		YES

*General part No. have no grade code.
Package is JEDEC code. (): ROHM Packages

Ultra Low Capacitance Bi-Directional Zener Diodes													
Product No.			Absolute Maximum Ratings (Ta=25°C)		Electrical Characteristics (Ta=25°C)		Peak Pulse Power (W) (tp=10×1000µs)			Remarks	Package	Equivalent Circuit Diagram	Automotive Grade AEC-Q101
Part No.	Grade Code		Po (mW)	Vz (V)	Iz (mA)	Ct (pF) (Typ.)	f (MHz)	Vr (V)					
	General	Automotive	Taping Code										
RSBC6.8CS	—	FH	T2RA	100	6.62 to 7.24	5	1typ.	1	0	SOD-923 (VMN2)	SOT-923 (VMN2M)	YES	
New RSBC6.8CM	*	—	T2R	100	6.62 to 7.24	5	1typ.	1	0			—	—

*General part No. have no grade code.
Package is JEDEC code. (): ROHM Packages

TVS

TVS Quick Reference

V _{RWM} (V)	2924 Size		3516 Size		4725 Size	
	Package	Part No.	Package	Part No.	Package	Part No.
	SOT-23 (SSD3)	MMBZ5V6AL MMBZ6V2AL MMBZ6V8AL	SOD-123FL (PMDU)	New SMF5V0 New SMF6V0 New SMF6V5 New SMF7V0 New SMF7V5 New SMF8V0	SOD-128 (PMDTM)	New VS5V0UA1LAM New VS6V0UA1LAM New VS7V0UA1LAM New VS8V0UA1LAM
3.0						
4.5						
5.0						
6.0		MMBZ9V1AL				
6.5		MMBZ10VAL				
7.0						
7.5						
8.0						
8.5		MMBZ12VAL				
9.0				New SMF9V0		New VS9V0UA1LAM
10.0				New SMF10V		New VS10VUA1LAM
11.0				New SMF11V		New VS11VUA1LAM
12.0		MMBZ15VAL		New SMF12V		New VS12VUA1LAM
13.0		MMBZ16VAL		New SMF13V		New VS13VUA1LAM
14.0				New SMF14V		New VS14VUA1LAM
14.5		MMBZ18VAL				
15.0				New SMF15V		New VS15VUA1LAM
16.0				New SMF16V		New VS16VUA1LAM
17.0		MMBZ20VAL				New VS17VUA1LAM
18.0				New SMF18V		New VS18VUA1LAM
20.0		MMBZ24VAL MMBZ27VCL MMBZ27VAL		New SMF20V New SMF22V		New VS20VUA1LAM New VS22VUA1LAM
22.0						
24.0		New RESDICAN MMBZ30VAL		New SMF24V		New VS24VUA1LAM
26.0		MMBZ33VAL		New SMF26V		New VS26VUA1LAM
28.0				New SMF28V		New VS28VUA1LAM
30.0				New SMF30V		New VS30VUA1LAM
33.0				New SMF33V		

Package is JEDEC code. (): ROHM Packages.

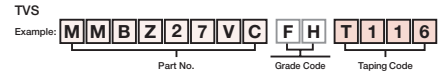

● Bi-Directional TVS

V _{RWM} (V)	Package	
	0402 Size	0603 Size
	DSN0402-2 (SMD0402)	DSN0603-2 (SMD0603)
3.3	RASMID VS3V3BA1FS RASMID VS3V3BB1FS New RASMID VS3V3BT1FS	New RASMID VS3V3BC1HS RASMID VS3V3BA1ES RASMID VS3V3BB1ES
5.0	RASMID VS5V0BA1FS RASMID VS5V0BB1FS	RASMID VS5V0BA1ES RASMID VS5V0BB1ES RASMID VS5V0BC1ES RASMID VS5V0BL1HS RASMID VS5V0BN1HS

©RASMID: ROHM's proprietary new method that enables superior dimensional precision, making it possible to develop the ultra-compact products. Package is JEDEC code. (): ROHM Packages.















TVS 1

Product No.				V _{RWM} (V)	Absolute Maximum Ratings (Ta=25°C) P _D (mW)	Electrical Characteristics (Ta=25°C)		Peak Pulse Power (W) (tp=10×1000µs)	Package	Equivalent Circuit Diagram	Automotive Grade AEC-Q101																		
Part No.	Grade Code		Taping Code			V _Z (V) or V _{BR} (V)	I _Z (mA)																						
	General	Automotive																											
New RESD1CAN		FH	T116	24	225	26.2 to 32.0	1	350(8/20µs)	SOT-23 (SSD3)		YES																		
MMBZ27VCL		FH	T116	22	225	25.65 to 28.35	1	40		SOT-23 (SSD3)		YES																	
MMBZ5V6AL		FH	T116	3	225	5.32 to 5.88	20	24			SOT-23 (SSD3)		YES																
MMBZ6V2AL		FH	T116	3	225	5.89 to 6.51	1	24				SOT-23 (SSD3)		YES															
MMBZ6V8AL		FH	T116	4.5	225	6.46 to 7.14	1	24					SOT-23 (SSD3)		YES														
MMBZ9V1AL		FH	T116	6	225	8.65 to 9.56	1	24						SOT-23 (SSD3)		YES													
MMBZ10VAL		FH	T116	6.5	225	9.50 to 10.50	1	24							SOT-23 (SSD3)		YES												
MMBZ12VAL		FH	T116	8.5	225	11.40 to 12.60	1	40								SOT-23 (SSD3)		YES											
MMBZ15VAL		FH	T116	12	225	14.25 to 15.75	1	40									SOT-23 (SSD3)		YES										
MMBZ16VAL		FH	T116	13	225	15.20 to 16.80	1	40										SOT-23 (SSD3)		YES									
MMBZ18VAL		FH	T116	14.5	225	17.10 to 18.90	1	40											SOT-23 (SSD3)		YES								
MMBZ20VAL		FH	T116	17	225	19.00 to 21.00	1	40												SOT-23 (SSD3)		YES							
MMBZ24VAL		FH	T116	20	225	22.80 to 25.20	1	40													SOT-23 (SSD3)		YES						
MMBZ27VAL		FH	T116	22	225	25.65 to 28.35	1	40														SOT-23 (SSD3)		YES					
MMBZ30VAL		FH	T116	24	225	28.50 to 31.50	1	40															SOT-23 (SSD3)		YES				
MMBZ33VAL		FH	T116	26	225	31.35 to 34.65	1	40																SOT-23 (SSD3)		YES			
New SMF5V0		TF	TR	5	1,000	6.40 or more	40	200	SOD-123FL (PMDU)																	YES			
New SMF6V0		TF	TR	6	1,000	6.67 or more	40	200		SOD-123FL (PMDU)																YES			
New SMF6V5	*	TF	TR	6.5	1,000	7.22 or more	40	200			SOD-123FL (PMDU)															YES			
New SMF7V0		TF	TR	7	1,000	7.78 or more	40	200				SOD-123FL (PMDU)														YES			
New SMF7V5		TF	TR	7.5	1,000	8.33 or more	40	200					SOD-123FL (PMDU)													YES			
New SMF8V0		TF	TR	8	1,000	8.89 or more	40	200						SOD-123FL (PMDU)												YES			
New SMF9V0		TF	TR	9	1,000	10.0 or more	40	200							SOD-123FL (PMDU)											YES			
New SMF10V		TF	TR	10	1,000	11.1 or more	20	200								SOD-123FL (PMDU)										YES			
New SMF11V		TF	TR	11	1,000	12.2 or more	20	200									SOD-123FL (PMDU)									YES			
New SMF12V		TF	TR	12	1,000	13.3 or more	20	200										SOD-123FL (PMDU)								YES			
New SMF13V		TF	TR	13	1,000	14.4 or more	20	200											SOD-123FL (PMDU)							YES			
New SMF14V		TF	TR	14	1,000	15.6 or more	20	200												SOD-123FL (PMDU)						YES			
New SMF15V		TF	TR	15	1,000	16.7 or more	20	200													SOD-123FL (PMDU)					YES			
New SMF16V		TF	TR	16	1,000	17.2 or more	20	200														SOD-123FL (PMDU)				YES			
New SMF18V		TF	TR	18	1,000	20.0 or more	20	200															SOD-123FL (PMDU)			YES			
New SMF20V		TF	TR	20	1,000	22.2 or more	10	200																SOD-123FL (PMDU)		YES			
New SMF22V		TF	TR	22	1,000	24.4 or more	10	200																	SOD-123FL (PMDU)		YES		
New SMF24V		TF	TR	24	1,000	26.7 or more	10	200																		SOD-123FL (PMDU)		YES	
New SMF26V		TF	TR	26	1,000	28.9 or more	10	200																			SOD-123FL (PMDU)		YES
New SMF28V		TF	TR	28	1,000	31.1 or more	10	200																				SOD-123FL (PMDU)	
New SMF30V		TF	TR	30	1,000	33.3 or more	10	200	SOD-123FL (PMDU)																				
New SMF33V		TF	TR	33	1,000	36.7 or more	10	200		SOD-123FL (PMDU)																			

*General part No. have no grade code. Package is JEDEC code. (): ROHM Packages

Switching Diodes

● Quick Reference for Switching Diodes

V _R (V)	Package						
	1006 Size		1212 Size	1608 Size	1616 Size		
							
	SOD-923 (VMN2)	SOD-923 (VMN2M)	SOT-723 (VMD3)	SOD-523 (EMD2)	SOT-416FL (EMD3F)	SOT-416 (EMD3)	SOT-543 (EMD4)
20			DA221M			DA221	
80	1SS400CS	1SS400CM	DAN222M DAP222M	1SS400SM	DAN222WM DAP222WM DAN217WM New DA228WM		DA227Y
V _R (V)	Package						
	2120 Size						
							
	SOT-323FL (UMD3F)	SOT-343 (UMD4)	SOT-353 (UMD5)	SOT-363 (UMD6)			
80	DAN202UM DAP202UM DAN217UM New DA228UM New BAW156UM New BAV199UM	DA227	UMN1N	UMN10N UMN20N UMR12N			
V _R (V)	Package						
	2512 Size	2924 Size	2928 Size				
							
	SOD-323FL (UMD2)	SOT-23 (SSD3)	SOT-346 (SMD3)	SOT-457 (SMD6)			
20			DA204K				
35	New 1SS380VM						
80	1SS355VM	BAS16HM BAV70HM BAW56HM BAV99HM BAW156HM BAV199HM New BAS116HM New BAV170HM	DAN202K DAP202K DAN217 DA228K	IMN10			
200	New BAS21VM	BAS21HM					

Package is JEDEC code. (): ROHM Packages

Switching Diodes

Switching Diodes









Example: **1SS400CSFH T2RA**
Part No. Grade Code Taping Code

High-speed Type																		
Product No.				Absolute Maximum Ratings(Ta=25°C)*1					Electrical Characteristics(Ta=25°C)*1						Package	Equivalent Circuit Diagram	Automotive Grade AEC-Q101	
Part No.	Grade Code General	Grade Code Automotive	Taping Code	V _{RM} (V)	V _R (V)	I _{FM} (mA)	I _o (mA)	I _{surge} (mA)	V _F (V) Max.	I _F (mA)	I _R (μA) Max.	V _R (V)	t _{rr} (ns) Max.	V _R (V)				I _F (mA)
1SS400CS		FH	T2RA	90	80	—	100	500(1s)	1.2	100	0.1	80	4	6	10	SOD-923 (VMN2)		YES
1SS400CM		—	T2R	90	80	—	100	500(1s)	1.2	100	0.1	80	4	6	10	SOD-923 (VMN2M)		—
1SS355VM		FH	TE-17	90	80	225	100	500(1s)	1.2	100	0.1	80	4	6	10	SOD-323FL (UMD2)		YES
1SS400SM		FH	T2R	90	80	225	100	500(1s)	1.2	100	0.1	80	4	6	10	SOD-523 (EMD2)		YES
BAS16HM		FH	T116	100	80	500	215*3	4,000(1μs)	1.25	150	0.1	80	4	10*2	10	SOT-23 (SSD3)		YES
DAN222M		FH	T2L	80	80	300	100	4,000(1μs)	1.2	100	0.1	70	4	6	5	SOT-723(VMD3)		YES
DAN222WM		FH	TL	80	80	300	100	4,000(1μs)	1.2	100	0.1	70	4	6	5	SOT-416FL (EMD3F)		YES
DAN202UM		FH	TL	80	80	300	100	4,000(1μs)	1.2	100	0.1	70	4	6	5	SOT-323FL (UMD3F)		YES
BAV70HM		FH	T116	90	80	450	215*3	4,000(1μs)	1.25	150	0.1	80	4	10*2	10	SOT-23(SSD3)		YES
DAN202K		FH	T146	80	80	300	100	4,000(1μs)	1.2	100	0.1	70	4	6	5	SOT-346(SMD3)	YES	
DAP222M		FH	T2L	80	80	300	100	4,000(1μs)	1.2	100	0.1	70	4	6	5	SOT-723(VMD3)		YES
DAP222WM		FH	TL	80	80	300	100	4,000(1μs)	1.2	100	0.1	70	4	6	5	SOT-416FL (EMD3F)		YES
DAP202UM	*	FH	TL	80	80	300	100	4,000(1μs)	1.2	100	0.1	70	4	6	5	SOT-323FL (UMD3F)		YES
BAW56HM		FH	T116	100	80	500	215*3	4,000(1μs)	1.25	150	0.1	80	4	10*2	10	SOT-23(SSD3)		YES
DAP202K		FH	T146	80	80	300	100	4,000(1μs)	1.2	100	0.1	70	4	6	5	SOT-346(SMD3)	YES	
DAN217WM		FH	TL	80	80	300	100	4,000(1μs)	1.2	100	0.1	70	4	6	5	SOT-416FL (EMD3F)		YES
DAN217UM		FH	TL	80	80	300	100	4,000(1μs)	1.2	100	0.2	70	4	6	5	SOT-323FL (UMD3F)		YES
BAV99HM		FH	T116	100	80	500	215*3	4,000(1μs)	1.25	150	0.1	80	4	10*2	10	SOT-23(SSD3)		YES
DAN217		FH	T146	80	80	300	100	4,000(1μs)	1.2	100	0.1	70	4	6	5	SOT-346(SMD3)		YES
UMN1N		FH	TR	80	80	80	25	250(1μs)	0.9	5	0.1	70	4	6	5	SOT-353 (UMD5)		YES
DA227Y		FH	T2R	80	80	300	100	400(1μs)	1.2	100	0.1	70	4	6	5	SOT-543(EMD4)		YES
DA227		FH	TL	80	80	300	100	4,000(1μs)	1.2	100	0.1	70	4	6	5	SOT-343(UMD4)		YES
UMN10N		FH	TR	80	80	300	100	4,000(1μs)	1.2	100	0.1	70	4	6	5	SOT-363(UMD6)		YES
IMN10		FH	T108	80	80	300	100	4,000(1μs)	1.2	100	0.1	70	4	6	5	SOT-457(SMD6)		YES
BAS21HM		FH	T116	250	200	—	215*3	10,000(1μs)	1	100	0.1	200	50	30*2	30	SOT-23 (SSD3)		YES
New BAS21VM		FH	TE-17	250	200	—	215*3	10,000(1μs)	1	100	0.1	200	50	30*2	30	SOD-323FL (UMD2)		YES
Low Leak Type																		
New 1SS380VM		FH	TE-17	40	35	225	100	400(1s)	1.2	100	0.01	20	—	—	—	SOD-323FL (UMD2)		YES
UMN20N		FH	TR	80	80	225	100	400(1s)	1.2	100	0.01	20	—	—	—	SOT-363 (UMD6)		YES
BAW156HM		FH	T116	100	80	500	215*3	4,000(1μs)	1.25	150	0.005	75	3,000	10*2	10	SOT-23 (SSD3)		YES
New BAW156UM		FH	TL	100	80	500	215*3	4,000(1μs)	1.25	150	0.005	75	3,000	10*2	10	SOT-323FL (UMD3F)		YES
DA221M		FH	T2L	20	20	200	100	300(1μs)	1	10	0.1	15	—	—	—	SOT-723 (VMD3)		YES
DA221		FH	TL	20	20	200	100	300(1μs)	1	10	0.1	15	—	—	—	SOT-416 (EMD3)		YES
BAV199HM		FH	T116	100	80	500	215*3	4,000(1μs)	1.25	150	0.005	75	3,000	10*2	10	SOT-23 (SSD3)		YES
New BAV199UM	*	FH	TL	100	80	500	215*3	4,000(1μs)	1.25	150	0.005	75	3,000	10*2	10	SOT-323FL (UMD3F)		YES
New DA228WM		FH	TL	80	80	200	100	4,000(1μs)	1.2	100	0.1	80	—	—	—	SOT-416FL (EMD3F)		YES
New DA228UM		FH	TL	80	80	200	100	300(1μs)	1.2	100	0.01	80	—	—	—	SOT-323FL (UMD3F)		YES
DA228K		FH	T146	80	80	200	100	300(1μs)	1.2	100	0.1	80	—	—	—	SOT-346 (SMD3)	YES	
DA204K		FH	T146	20	20	200	100	300(1μs)	1	10	0.1	15	—	—	—	SOT-346(SMD3)	YES	
New BAV170HM		FH	T116	90	80	500	215*3	4,000(1μs)	1.25	150	0.005	75	—	—	—	SOT-23(SSD3)		YES
New BAS116HM		FH	T116	100	80	500	215*3	4,000(1μs)	1.25	150	0.005	75	—	—	—	SOT-23 (SSD3)		YES
UMR12N		FH	TN	80	80	200	100	300(1μs)	1.2	100	0.1	80	—	—	—	SOT-363(UMD6)		YES











*General part No. have no grade code.
 *1: Value/Chip *2: Not V_R(V) but I_F(mA) Value *3: I_F Value
 Package is JEDEC code. () : ROHM Packages

High Frequency Diodes

Quick Reference for High Frequency Diodes

	V _R (V)	Package							
		0603 Size	1006 Size		1608 Size	1616 Size	2512 Size	2120 Size	2928 Size
									
		SOD-962 (GMD2)	SOD-923 (VMN2)	SOD-923 (VMN2M)	SOD-523 (EMD2)	SOT-543 (EMD4)	SOD-323FL (UMD2)	SOT-323 (UMD3)	SOT-346 (SMD3)
Band Switching Diodes	35				New 1SS390SM		1SS356		
PIN Diodes	30	RN142ZS	RN242CS RN262CS						
	50			New RN141CM			RN731V RN771V	RN739F RN779F	RN779D
	60				New RN142SM				
Detection Schottky Diodes	3						RB851Y		
	5			New RB886CM			RB861Y		
	15						RB886Y		

Package is JEDEC code. () : ROHM Packages.

Band Switching Diodes																
Product No.			Absolute Maximum Ratings(Ta=25°C)*1				Electrical Characteristics(Ta=25°C)*1						Package	Equivalent Circuit Diagram	Automotive Grade AEC-Q101	
Part No.	Grade Code		Taping Code	V _R (V)	I _F (mA)	T _J (°C)	T _{stg} (°C)	Ct(pF) Max.	V _R (V)	f(MHz)	rF(Ω) Max.	I _F (mA)				f(MHz)
	General	Automotive											General	Automotive		
New 1SS390SM		FH	T2R	35	150	150	-55 to +150	1.2	6	1	0.9	2	100	SOD-523(EMD2)		YES
1SS356	*	FH	TW11	35	125	125	-55 to +125	1.2	6	1	0.9	2	100	SOD-323FL (UMD2)		YES
PIN Diodes																
Product No.			Absolute Maximum Ratings(Ta=25°C)*1				Electrical Characteristics(Ta=25°C)*1						Package	Equivalent Circuit Diagram	Automotive Grade AEC-Q101	
Part No.	Grade Code		Taping Code	V _R (V)	I _F (mA)	T _J (°C)	T _{stg} (°C)	Ct(pF) Max.	V _R (V)	f(MHz)	rF(Ω) Max.	I _F (mA)				f(MHz)
	General	Automotive											General	Automotive		
RN142ZS			T2R	30	50	150	-55 to +150	0.45	1	1	2.5	3	100	SOD-962(GMD2)		—
RN242CS			T2RA	30	100	150	-55 to +150	0.35	1	1	3	3	100	SOD-923 (VMN2)		—
RN262CS			T2RA	30	100	150	-55 to +150	0.4	1	1	2.8	3	100	SOD-923(VMN2M)		—
New RN141CM			T2R	50	100	150	-55 to +150	0.8	1	1	2	3	100	SOD-923(VMN2M)		—
New RN142SM			T2R	60	100	150	-55 to +150	0.45	1	1	3	3	100	SOD-523(EMD2)	—	
RN731V		FH	TE-17	50	50	125	-55 to +150	0.4	35	1	7	10	100	SOD-323FL (UMD2)		YES
RN771V		FH	TE-17	50	50	150	-55 to +150	0.9	35	1	7	10	100	SOD-323FL (UMD2)		YES
RN739F		FH	T106	50	50	125	-55 to +150	0.4	35	1	7	10	100	SOT-323 (UMD3)		YES
RN779F		FH	T106	50	50	150	-55 to +150	0.9	35	1	7	10	100	SOT-323 (UMD3)		YES
RN779D		FH	T146	50	50	150	-55 to +150	0.9	35	1	7	10	100	SOT-346(SMD3)		YES
Detection Schottky Diodes																
Product No.			Absolute Maximum Ratings(Ta=25°C)*1				Electrical Characteristics(Ta=25°C)*1						Package	Equivalent Circuit Diagram	Automotive Grade AEC-Q101	
Part No.	Grade Code		Taping Code	V _R (V)	I _F (mA)	T _J (°C)	T _{stg} (°C)	V _F (V) Max.	I _F (mA)	Ct(pF) Max.	V _R (V)	f(MHz)				
	General	Automotive											General	Automotive		
RB886Y			T2R	15	10	125	-40 to +125	0.35	1	0.8	1	1	SOT-543(EMD4)		—	
RB851Y			T2R	3	30	125	-40 to +125	0.46	1	0.8	0	1	SOT-543(EMD4)		—	
RB861Y			T2R	5	10	125	-40 to +125	0.3	1	1.1	0	1	SOT-543(EMD4)		—	
New RB886CM			T2R	5	10	125	-40 to +125	0.35	1	0.45	1	1	SOD-923(VMN2M)			—

* : General part No. have no grade code.

*1 : Value/Chip

Package is JEDEC code. () : ROHM Packages.

Packages

■ Dimensions (Unit : mm)

Surface Mount Type

DSN0402-2(SMD0402) 	DSN0603-2(SMD0603) 	SOD-962(GMD2) 	DSN1006-2(SMD1006) 	DFN1006-2(VML2)
SOD-923(VMN2) 	SOD-923(VMN2M) 	SOD-723(VMD2) [SC-104A] 	SOT-723(VMD3) [SC-105AA] 	SOD-523(EMD2) [SC-79]
SOT-416(EMD3) [SC-75A] 	SOT-416FL(EMD3F) [SC-89] 	SOT-543(EMD4) [SC-107A] <p>Each lead has same dimensions</p>	SOT-553(EMD5) [SC-107BB] 	SOT-563(EMD6) [SC-107C] <p>Each lead has same dimensions</p>
SOD-323FL(UMD2) [SC-90A] 	SOT-323(UMD3) [SC-70] 	SOT-323FL(UMD3F) [SC-85] 	SOT-343(UMD4) [SC-82] <p>Each lead has same dimensions</p>	SOT-353(UMD5) [SC-88A]
SOT-353T(TUMD5) [SC-113CA] 	SOT-363(UMD6) [SC-88] <p>Each lead has same dimensions</p>	SOT-23(SSD3) 	SOT-346(SMD3) [SC-59] 	SOT-25(SMD5) [SC-74A]
SOT-457(SMD6) [SC-74] <p>Each lead has same dimensions</p>	SOT-25T(TSMD5) [SC-95] 	SOT-457T(TSMD6) [SC-95] <p>Each lead has same dimensions</p>	(TSMD8) <p>Each lead has same dimensions</p>	(TUMD2M) [SC-108B]
(TUMD2SM) 	(TUMD2) 			

Package is JEDEC code. () : ROHM Packages, [] : JEITA Code

Power Packages

● Dimensions (Unit : mm)

Surface Mount Type

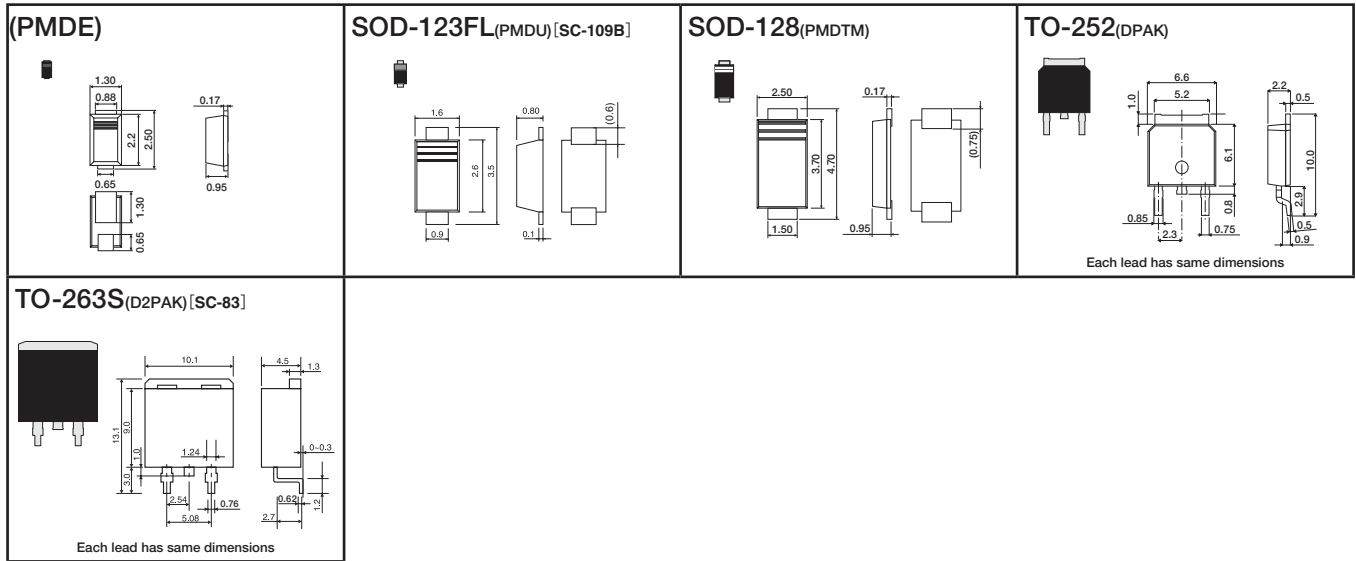

Package is JEDEC code. () : ROHM Packages, [] : JEITA Code

Leaded Type

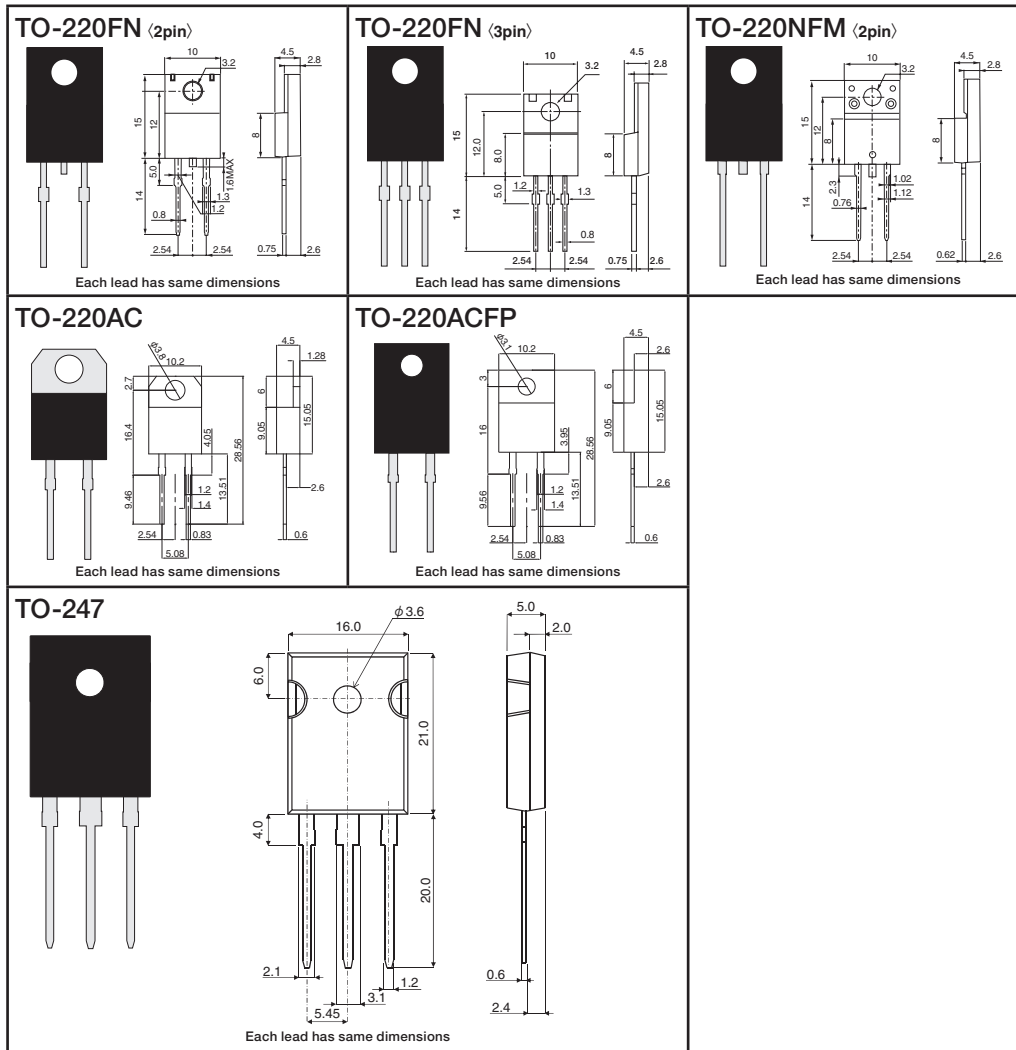

Package is JEDEC code.

Product No. Explanation

- When ordering, specify the part number.
- Check each code against the tables shown below.
- Fill in from the left, leaving any extra boxes empty on the right.

• Schottky Barrier Diodes

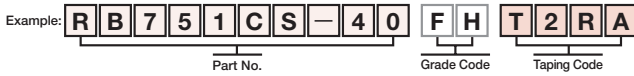

• Fast Recovery Diodes

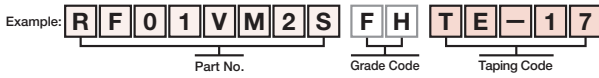

• Rectifier Diodes



• Zener Diodes

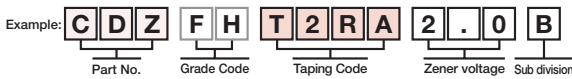

• Zener Diodes as ESD Protection

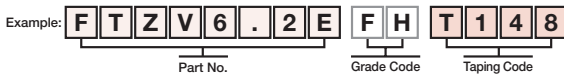

• TVS

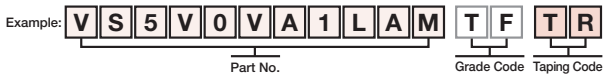

• Switching Diodes

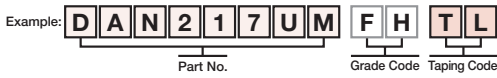

• High Frequency Diodes

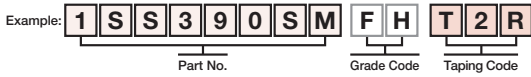

• Packaging type

Package	Code	ROHM Package	Package Style	Direction	Basic ordering unit(pcs)	
Surface Mount type	DSN0402-2	T27R	SMD0402	Embossed tape	Cathode on sprocket hole side	27,000
		T27N		Embossed tape	Non-direction	
	DSN0603-2	T15R	SMD0603	Embossed tape	Cathode on sprocket hole side	15,000
		T2N	GMD2	Embossed tape	Non-direction	
	SOD-962	T2R	VML2	Embossed tape	Cathode on sprocket hole side	8,000
		T2N	VMN2	Embossed tape	Non-direction	
	DFN1006-2	T2R	VML2	Embossed tape	Cathode on sprocket hole side	8,000
	SOD-923	T2RA	VMN2	Embossed tape	Cathode on sprocket hole side	
	SOD-923	T2R	VMN2M	Embossed tape	Cathode on sprocket hole side	8,000
	SOD-723	T2R	VMD2	Embossed tape	Cathode on sprocket hole side	
	DFN1608-2	T2R	KMD2	Embossed tape	Cathode on sprocket hole side	8,000
	SOT-723	T2L	VMD3	Embossed tape	One terminal on sprocket hole side	
	SOD-523	TE61	EMD2	Embossed tape	Cathode on sprocket hole side	3,000
		T2R		Embossed tape	Cathode on sprocket hole side	
		T2N		Embossed tape	Non-direction	
	SOT-416	TL	EMD3	Embossed tape	One terminal on sprocket hole side	3,000
	SOT-416FL	TL	EMD3F	Embossed tape	One terminal on sprocket hole side	
	SOT-543	T2R	EMD4	Embossed tape	Cathode on sprocket hole side	8,000
	SOT-553	T2R	EMD5	Embossed tape	Cathode on sprocket hole side	
	SOT-563	T2R	EMD6	Embossed tape	Cathode on sprocket hole side	8,000
	SOD-323FL	TE-17	UMD2	Embossed tape	Cathode on sprocket hole side	
		TW11				
	SOT-323	T106	UMD3	Embossed tape	One terminal on sprocket hole side	3,000
	SOT-323FL	TL	UMD3F	Embossed tape	One terminal on sprocket hole side	
	SOT-343	TL	UMD4	Embossed tape	Cathode on sprocket hole side (DA227)	3,000
	SOT-353	TR	UMD5	Embossed tape	Three terminals on sprocket hole side	
	SOT-363	TN	UMD6	Embossed tape	Non-direction	3,000
		TR		Embossed tape	Cathode on sprocket hole side	
	SOT-23	T116	SSD3	Embossed tape	One terminal on sprocket hole side	3,000
	SOT-346	T146	SMD3	Embossed tape	One terminal on sprocket hole side	
	SOT-25	T148	SMD5	Embossed tape	Three terminals on sprocket hole side	3,000
	SOT-457	T108	SMD6	Embossed tape	Anode on sprocket hole side	
		T110		Embossed tape	Non-direction	
	SOT-25T	TR	TSMD5	Embossed tape	Terminal No.1 on sprocket hole side	3,000
	SOT-457T	TR	TSMD6	Embossed tape	Terminal No.1 on sprocket hole side	
	TSMD8	TR	TSMD8	Embossed tape	Terminal No.1 on sprocket hole side	3,000
	SOD-323HE	TR	TUMD2	Embossed tape	Cathode on sprocket hole side	
		TR	TUMD2S	Embossed tape	Cathode on sprocket hole side	
		TR	TUMD2M	Embossed tape	Cathode on sprocket hole side	
		TR	TUMD2SM	Embossed tape	Cathode on sprocket hole side	
SOT-353T	TR	TUMD5	Embossed tape	Terminal No.1 on sprocket hole side	3,000	
—	TR	PMDE	Embossed tape	Cathode on sprocket hole side		
SOD-123FL	TR	PMDU	Embossed tape	Cathode on sprocket hole side	3,000	
SOD-128	TR	PMDTM	Embossed tape	Cathode on sprocket hole side		
TO-252(DPAK)	TL	—	Embossed tape	Fin on sprocket hole side	2,500	
TO-263S(D2PAK)	TL	—	Embossed tape	Fin on sprocket hole side		
Leaded type	TO-220FN	C9	—	Stick	box	1,000
	TO-220NFM	C9	—	Stick	box	1,000
	TO-220AC	C9	—	Stick	box	1,000
	TO-220ACFP	C9	—	Stick	box	1,000
TO-247	C11	—	Stick	box	450	



Passive Devices

Resistors

CONTENTS

- **Quick Reference of Resistance Range** P. D2
- **Class-leading Compact Size Chip Resistors (RAS MID series)**
 - Ultra-Compact Chip Resistors (SMR003 <009005>) P. D3
- **Thick Film Chip Resistors (Standard series)**
 - Compact Chip Resistors (MCR series <01005 to 0805>) P. D4
 - Chip Resistors (MCR series <1206 to 2512>) P. D5
 - Compact Chip Resistor Networks (MNR series <0402×2 to 1206×4>) P. D6
 - 8-element Chip Resistor Networks (MNR series <0603×5 to 1206×5>) P. D7
- **Thick Film Chip Resistors (High Reliability series)**
 - High Anti-surge Chip Resistors (SDR series) P. D8
 - Anti-surge Chip Resistors (ESR series) P. D8
 - High Power Chip Resistors <Wide Terminal type> (LTR series) P. D9
 - High Voltage Resistance Chip Resistors (KTR series) P. D10
 - Tolerance for Sulfurization Chip Resistor (SFR series) P. D11
- **Chip Resistors for Current Detection (Thick Film type)**
 - Chip Resistors (Low Ohmic MCR series) P. D12
 - Low Ohmic Chip Resistors <Face Down type> (UCR series) P. D13
 - High Power Chip Resistors <Wide Terminal type> (Low Ohmic LTR series) P. D14
- **Chip Resistors for Current Detection (Metal Plate type)**
 - Ultra Low Ohmic Chip Shunt Resistors (PMR series) P. D15
 - Ultra Low Ohmic Chip Shunt Resistors <Wide Terminal type> (PML series) P. D16
 - High Power Ultra Low Ohmic Chip Shunt Resistors (PSR series) P. D17
 - High Power Low Ohmic Chip Shunt Resistors (GMR series) P. D18
- **Standard Nominal Resistance Values** P. D19

ISO9001-/IATF 16949-approved



Quick Reference of Resistance Range

Low Ohmic Resistor Lineup

Part No./mm[inch]/Page

PSR GMR PML PMR Metal Strip UCR LTR MCR Thick Film

Power Rating (W)	Resistance[Ω]							
	0.1m	1m	10m	100m	1	10		
5	0.1m PSR500/15×7.75[5931]/P.D17	2m	5m ☆GMR320/7142[2817]/P.D18	100m				
4	0.2m PSR400/10×5.2[3921]/P.D17	3m						
3	0.3m PSR100/6432[2512]/P.D17	3m	5m GMR100/6432[2512]/P.D18	220m				
2	0.5m	2.2m PML100/3264[1225]/P.D16	5m ☆GMR50/5025[2010]/P.D18	200m				
	0.5m	1m PMR100/6432[2512]/P.D15	10m	100m LTR100/3264[1225]/P.D14	910m			
1.5		0.5m	2.2m PML50/2550[1020]/P.D16					
1	PMR25/3225[1210]/P.D15	1m	PMR50/5025[2010]/P.D15	10m	47m	MCR100/6432[2512]/P.D12	9.1	
	0.5m	1m	PMR18/3216[1206]/P.D15	10m	10m	LTR18/1632[0612]/P.D14	1	
0.66	PML10/1220[0508]/P.D16	1m	2.5m					
1/2				47m	MCR50/5025[2010]/P.D12	9.1		
				47m	MCR25/3225[1210]/P.D12	9.1		
1/3			2m	PMR10/2012[0805]/P.D15	10m	47m	LTR10/1220[0508]/P.D14	9.1
				11m	UCR18/3216[1206]/P.D13	100m		
1/4				11m	UCR10/2012[0805]/P.D13	100m		
				47m	MCR18/3216[1206]/P.D12	9.1		
1/5				47m	MCR10/2012[0805]/P.D12	9.1		
				PMR03/1608[0603]/P.D15	10m	20m	UCR03/1608[0603]/P.D13	200m
1/8				PMR01/1005[0402]/P.D15	10m		68m	UCR01/1005[0402]/P.D13
1/10							100m	UCR006/0603[0201]/P.D13
1/16								MCR03/1608[0603]/P.D12
1/20								MCR01/1005[0402]/P.D12
								MCR006/0603[0201]/P.D12

☆: Under Development

1 Ω or more Resistor Lineup

Part No./mm[inch]/Page

ESR SDR KTR LTR MCR SFR SMR Thick Film

Power Rating (W)	Resistance[Ω]								
	1	10	100	1k	10k	100k	1M	10M	30M
2									
1									
0.75									
0.66									
1/2									
2/5									
1/3									
1/4									
1/5									
1/8									
1/10									
1/16									
1/20									
1/32									
1/50									

☆: Under Development

D Resistors

Class-leading Compact Size Chip Resistors(RASMID series) Ultra-Compact Chip Resistors (SMR003 <009005>)

- Original process technology ensures greater accuracy
- Chip dimensional precision improved from $\pm 20\mu\text{m}$ to $\pm 10\mu\text{m}$
- Gold electrodes utilized for superior solderability and reliability

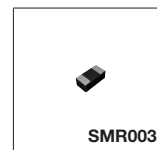

SMR003 <009005>								
Part No.	Size Code mm(inch)	Rated Power (70°C)	Limiting Element Voltage (V)	Tolerance	Temperature Coefficient (ppm/°C)	Resistance Range	Operating Temperature (°C)	Automotive Grade AEC-Q200
SMR003	03015 (009005)	0.020W (1/50W)	10	J(±5%)	±200	10 to 1MΩ(E24 Series)	-55 to +125	—
				F(±1%)		10 to 1MΩ(E24, 96 Series)		

*E24 : Standard products E96 : Custom products

Jumper type					
Part No.	Size Code mm(inch)	Rated Current	Resistance	Operating Temperature(°C)	Automotive Grade AEC-Q200
SMR003	03015(009005)	0.5A	50mΩ Max.	-55 to +125	—

Dimensions(Unit : mm)

Part No.	Size Code mm(inch)	L	W	t	a	b
SMR003	03015 (009005)	0.30 ± 0.01	0.15 ± 0.01	0.11 ± 0.01	—	0.07 ± 0.01

SMR003

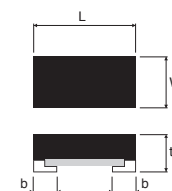

Part No. Explanation

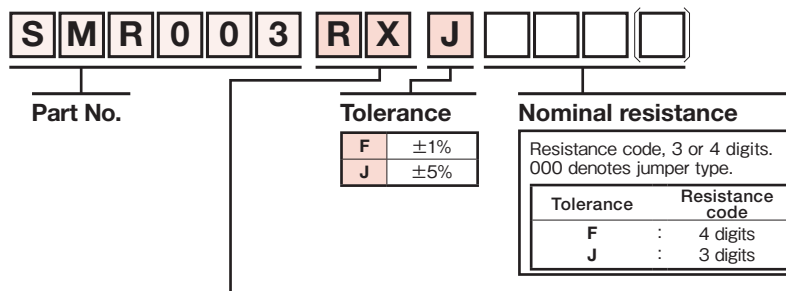

Packaging Specifications Code

Part No.	Code	Tolerance		Packaging Specifications	Reel	Basic Ordering Unit (pcs)
		J(±5%)	F(±1%)			
SMR003	RX	○	○	Embossed tape(1mm Pitch)	φ180mm(7inch)	40,000

Reel (φ180mm) : Compatible with JEITA standard "EIAJ ET-7200B"
○ : Standard product

*RASMID : ROHM's proprietary new method that enables superior dimensional precision, making it possible to develop the ultra-compact products

Thick Film Chip Resistors (Standard series) Compact Chip Resistors (MCR series <01005 to 0805>)

- High reliability chip resistors optimized for a variety of applications.
- Nine package sizes, ranging from 01005 to 2512.
- Market-proven reliability.

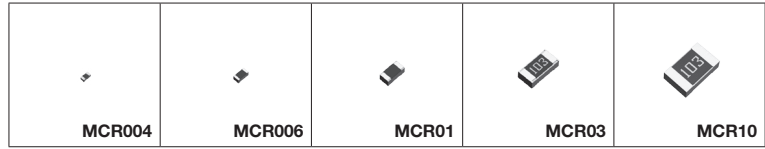

MCR series <01005 to 0805>									
Part No.	Size Code mm(inch)	Rated Power (70°C)	Limiting Element Voltage (V)	Tolerance	Temperature Coefficient (ppm/°C)	Resistance Range		Operating Temperature (°C)	Automotive Grade AEC-Q200
MCR004	0402 (01005)	0.031W (1/32W)	15	J(±5%)	+600/−200 ±300 ±250	1Ω to 9.1Ω (E24 Series)	9.1Ω to 91Ω (E24 Series)	−55 to +125	—
				F(±1%)	±300 ±250	100Ω to 3MΩ (E24 Series)	100Ω to 3MΩ (E24,96 Series)		
MCR006	0603 (0201)	0.05W (1/20W)	25	J(±5%)	+600/−200 ±200	1Ω to 9.1Ω (E24 Series)	9.1Ω to 10MΩ (E24 Series)	−55 to +155	Yes
				F(±1%)	±200	10Ω to 10MΩ (E24,96 Series)	10Ω to 10MΩ (E24,96 Series)		
				D(±0.5%)	±200 ±100	10Ω to 97.6Ω (E24,96 Series)	1kΩ to 1MΩ (E24,96 Series)		
MCR01	1005 (0402)	0.063W*1 (1/16W)	50	J(±5%)	+500/−250 ±200	1Ω to 9.1Ω (E24 Series)	9.1Ω to 10MΩ (E24 Series)	−55 to +155	Yes
				F(±1%)	±100	10Ω to 2.2MΩ (E24,96 Series)	10Ω to 2.2MΩ (E24,96 Series)		
				D(±0.5%)	±100 ±50	10Ω to 97.6Ω (E24,96 Series)	100Ω to 1MΩ (E24,96 Series)		
MCR03	1608 (0603)	0.1W*1 (1/10W)	50	J(±5%)	±400 ±200	1Ω to 9.1Ω (E24 Series)	9.1Ω to 10MΩ (E24 Series)	−55 to +155	Yes
				FX(±1%)	±100	10Ω to 10MΩ (E24,96 Series)	10Ω to 10MΩ (E24,96 Series)		
				D(±0.5%)	±100 ±50	10Ω to 97.6Ω (E24,96 Series)	100Ω to 1MΩ (E24,96 Series)		
MCR10	2012 (0805)	0.125W*1 (1/8W)	150	J(±5%)	±400 ±200	1Ω to 9.1Ω (E24 Series)	9.1Ω to 10MΩ (E24 Series)	−55 to +155	Yes
				F(±1%)	±100	10Ω to 2.2MΩ (E24,96 Series)	10Ω to 2.2MΩ (E24,96 Series)		
				D(±0.5%)	±100 ±50	10Ω to 97.6Ω (E24,96 Series)	100Ω to 1MΩ (E24,96 Series)		

*1 : Please contact us for the higher rated power.
*E24 : Standard products E96 : Custom products

Jumper type					
Part No.	Size Code mm(inch)	Rated Current	Resistance	Operating Temperature(°C)	Automotive Grade AEC-Q200
MCR004	0402(01005)	0.5A	50mΩ Max.	−55 to +125	—
MCR006	0603(0201)	0.5A		−55 to +155	Yes
MCR01	1005(0402)	1A		−55 to +155	Yes
MCR03	1608(0603)	1A		−55 to +155	Yes
MCR10	2012(0805)	2A		−55 to +155	Yes

Dimensions (Unit : mm)

Part No.	Size Code mm(inch)	L	W	t	a	b
MCR004	0402(01005)	0.4 ± 0.02	0.2 ± 0.02	0.13 ± 0.02	0.1 ± 0.03	0.1 ± 0.03
MCR006	0603(0201)	0.6 ± 0.03	0.3 ± 0.03	0.23 ± 0.03	0.1 ± 0.05	0.15 ± 0.05
MCR01	1005(0402)	1.0 ± 0.05	0.5 ± 0.05	0.35 ± 0.05	0.2 ± 0.1	0.25 ^{+0.05} _{−0.10}
MCR03	1608(0603)	1.6 ± 0.1	0.8 ± 0.1	0.45 ± 0.1	0.3 ± 0.2	0.3 ± 0.2
MCR10	2012(0805)	2.0 ± 0.1	1.25 ± 0.1	0.55 ± 0.1	0.4 ± 0.2	0.4 ± 0.2

- MCR004/006/01
- MCR03 (Partially marked)

- MCR10

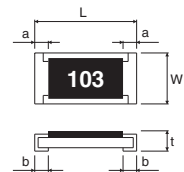
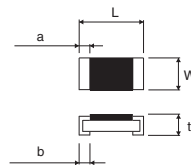

Part No. Explanation



Part No.

Tolerance

Nominal resistance

D	±0.5%
F(X)	±1%
J	±5%

J is also used for jumper

Resistance code, 3 or 4 digits. 000 denotes jumper type.	
Tolerance	Resistance code
D, F(X)	: 4 digits
J	: 3 digits

Packaging Specifications Code

Part No.	Code	Tolerance			Packaging Specifications	Reel	Basic Ordering Unit (pcs)	Remarks
		J(±5%)	F(±1%)	D(±0.5%)				
MCR004	QLP	○	○	—	Paper tape(2mm Pitch)	φ180mm(7inch)	20,000	—
MCR006	YLP	○	○	○	Paper tape(2mm Pitch)	φ180mm(7inch)	15,000	—
MCR01	MZP	○	○	○	Paper tape(2mm Pitch)	φ180mm(7inch)	10,000	—
MCR03	EZP	○	○(FX)	○	Paper tape(4mm Pitch)	φ180mm(7inch)	5,000	—
MCR10	EZP	○	○	○	Paper tape(4mm Pitch)	φ180mm(7inch)	5,000	—

Reel(φ180mm) : Compatible with JEITA standard "EIAJ ET-7200B"
○ : Standard product

Thick Film Chip Resistors (Standard series) Chip Resistors (MCR series <1206 to 2512>)

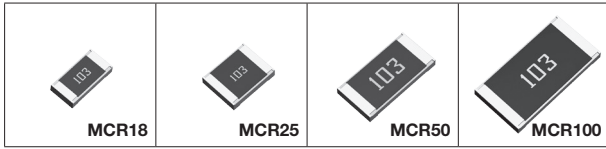

MCR series <1206 to 2512>								
Part No.	Size Code mm(inch)	Rated Power (70°C)	Limiting Element Voltage (V)	Tolerance	Temperature Coefficient (ppm/°C)	Resistance Range	Operating Temperature (°C)	Automotive Grade AEC-Q200
MCR18	3216 (1206)	0.25W (1/4W) 0.125W (1/8W)	200	J(±5%)	±400 ±200	1Ω to 9.1Ω (E24 Series) 10Ω to 10MΩ (E24 Series)	-55 to +155	Yes
				F(±1%)	±100	10Ω to 2.2MΩ (E24,96 Series)		
				D(±0.5%)	±100 ±50	10Ω to 97.6Ω (E24,96 Series) 100Ω to 1MΩ (E24,96 Series)		
MCR25	3225 (1210)	0.25W to 0.5W*1 (1/4W to 1/2W)	200	J(±5%)	500±350 ±500 ±200	1Ω to 2Ω (E24 Series) 2.2Ω to 5.1Ω (E24 Series) 5.6Ω to 3.3MΩ (E24 Series)	-55 to +155	Yes
				F(±1%)	±100	10Ω to 1.0MΩ (E24,96 Series)		
MCR50	5025 (2010)	0.5W (1/2W)	200	J(±5%)	500±350 ±500 ±200 ±350	1Ω to 2Ω (E24 Series) 2.2Ω to 9.1Ω (E24 Series) 10Ω to 330kΩ (E24 Series) 360kΩ to 560kΩ (E24 Series)	-55 to +125	Yes
				F(±1%)	±100	10Ω to 180kΩ (E24,96 Series)		
MCR100	6432 (2512)	1W	200	J(±5%)	500±350 ±500 ±350 ±200	1Ω to 2Ω (E24 Series) 2.2Ω to 9.1Ω (E24 Series) 10Ω to 22Ω (E24 Series) 24Ω to 100kΩ (E24 Series)	-55 to +125	Yes
				F(±1%)	±100	10Ω to 82kΩ (E24,96 Series)		

*1 : Rated power 1Ω to 9.76Ω : 0.25W, 10Ω to 9.76kΩ : 0.5W, 10kΩ to 3.3MΩ : 0.33W
*E24 : Standard products E96 : Custom products

Jumper type					
Part No.	Size Code mm(inch)	Rated Current	Resistance	Operating Temperature(°C)	Automotive Grade AEC-Q200
MCR18	3216(1206)	2A	50mΩ Max.	-55 to +155	Yes
MCR25	3225(1210)	2A			Yes
MCR50	5025(2010)	3A			Yes
MCR100	6432(2512)	4A		-55 to +125	Yes

Dimensions (Unit : mm)

Part No.	Size Code mm(inch)	L	W	t	a	b
MCR18	3216(1206)	3.2±0.15	1.6±0.15	0.55±0.1	0.5±0.25	0.5±0.25
MCR25	3225(1210)	3.2±0.15	2.5±0.15	0.55±0.15	0.5±0.25	0.5±0.25
MCR50	5025(2010)	5.0±0.15	2.5±0.15	0.55±0.15	0.6±0.25	0.6±0.25
MCR100	6432(2512)	6.3±0.15	3.2±0.15	0.55±0.15	0.6±0.25	0.6±0.25

● MCR18/25/50/100

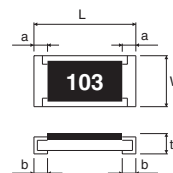

Part No. Explanation

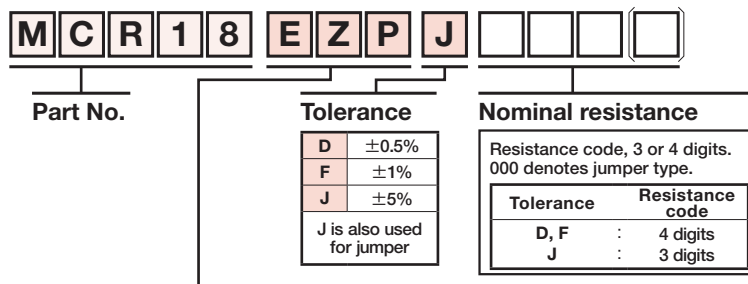

Packaging Specifications Code

Part No.	Code	Tolerance			Packaging Specifications	Reel	Basic Ordering Unit (pcs)
		J(±5%)	F(±1%)	D(±0.5%)			
MCR18	EZP	○	○	○	Paper tape(4mm Pitch)	φ180mm(7inch)	5,000
MCR25	JZH	○	○	—	Embossed tape(4mm Pitch)	φ180mm(7inch)	4,000
MCR50	JZH	○	○	—	Embossed tape(4mm Pitch)	φ180mm(7inch)	4,000
MCR100	JZH	○	○	—	Embossed tape(4mm Pitch)	φ180mm(7inch)	4,000

Reel(φ180mm) : Compatible with JEITA standard "EIAJ ET-7200B"
○ : Standard product

Thick Film Chip Resistors (Standard series) Compact Chip Resistor Networks (MNR series <0402×2 to 1206×4>)

- Reduces cost
Use of chip networks reduces the number of components and saves mounting space.
- Easy fillet inspection
Convex type electrodes facilitate visual inspection of fillets.
Inspection can be performed with automatic inspection equipment.

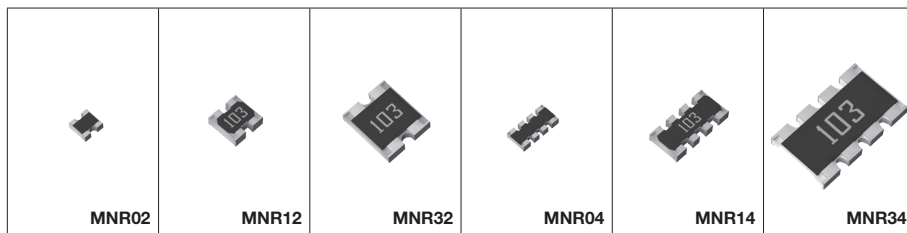

MNR series <0402×2 to 1206×4>											
Part No.	Size Code mm(inch)	No. of Terminals	No. of Elements	Rated Power (70°C)	Limiting Element Voltage (V)	Tolerance	Temperature Coefficient (ppm/°C)	Resistance Range	Operating Temperature (°C)	Automotive Grade AEC-Q200	
MNR02	1005(0402)×2	4	2	0.063W/Element	25	J(±5%)	±200	10Ω to 1MΩ (E24 Series)	-55 to +155	Yes	
MNR04	1005(0402)×4	8	4	0.063W/Element	25	J(±5%)	+500/-250 ±200	1Ω to 9.1Ω (E24 Series) 10Ω to 1MΩ (E24 Series)		Yes	
MNR12	1608(0603)×2	4	2	0.063W/Element	50	J(±5%) F(±1%)	±200 ±100	10Ω to 1MΩ (E24 Series)		Yes	
MNR14	1608(0603)×4	8	4	0.063W/Element	50	J(±5%) F(±1%)	±500 ±200 ±100	2.2Ω to 6.8Ω (E6 Series) 10Ω to 1MΩ (E24 Series) 10Ω to 1MΩ (E24 Series)		Yes	
MNR32	3216(1206)×2	4	2	0.125W/Element	200	J(±5%)	±200	10Ω to 1MΩ (E24 Series)		-55 to +125	Yes
MNR34	3216(1206)×4	8	4	0.125W/Element	200	J(±5%)	±200	10Ω to 1MΩ (E24 Series)			Yes

Jumper type					
Part No.	Size Code mm(inch)	Rated Current	Resistance	Operating Temperature (°C)	Automotive Grade AEC-Q200
MNR02	1005(0402)×2	1A/Element	50mΩ Max.	-55 to +155	Yes
MNR04	1005(0402)×4	1A/Element			Yes
MNR12	1608(0603)×2	1A/Element			Yes
MNR14	1608(0603)×4	1A/Element		Yes	
MNR32	3216(1206)×2	2A/Element		-55 to +125	Yes
MNR34	3216(1206)×4	2A/Element			Yes

Dimensions (Unit : mm)

- MNR02/MNR12/MNR32 (Marked except MNR02)
Different marking system may apply to each product type.

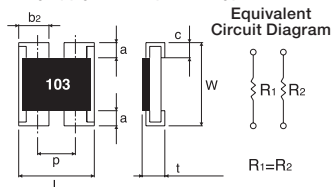

- MNR04/MNR14/MNR34 (Marked except MNR04)
Different marking system may apply to each product type.

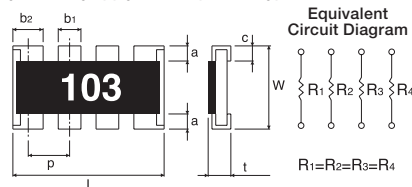

Part No.	L	W	t	a	b2	c	p
MNR02	1.0±0.1	1.0±0.1	0.35±0.1	0.2±0.1	0.33 ^{+0.1} _{-0.05}	0.25±0.1	0.68
MNR12	1.6±0.1	1.6±0.1	0.5±0.1	0.3±0.2	0.6±0.15	0.25±0.15	0.8
MNR32	2.6±0.2	3.1±0.2	0.55±0.1	0.5±0.3	1.0±0.2	0.5Max.	1.27

Part No.	L	W	t	a	b1	b2	c	p
MNR04	2.0±0.1	1.0±0.1	0.35±0.1	0.2±0.1	0.3±0.1	0.4±0.1	0.25±0.1	0.5
MNR14	3.2±0.1	1.6±0.1	0.5±0.1	0.3±0.2	0.4±0.15	0.6±0.15	0.25±0.15	0.8
MNR34	5.2±0.4	3.1±0.2	0.55±0.1	0.5±0.3	0.8±0.2	1.0±0.2	0.5Max.	1.27

Part No. Explanation

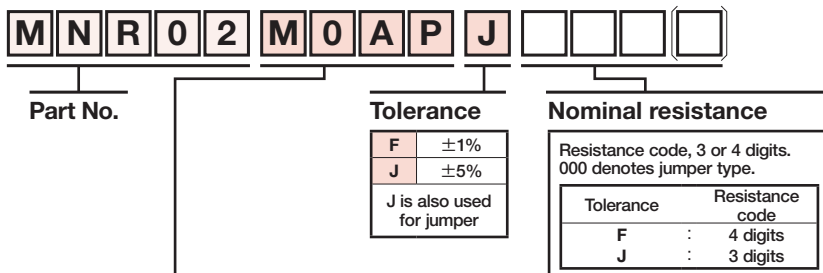

Packaging Specifications Code

Part No.	Code	Tolerance		Packaging Specifications	Reel	Basic Ordering Unit (pcs)
		J(±5%)	F(±1%)			
MNR02	M0AP	○	—	Paper tape(2mm Pitch)	φ180mm(7inch)	10,000
MNR04	M0AP	○	—	Paper tape(2mm Pitch)	φ180mm(7inch)	10,000
MNR12	E0AP	○	○	Paper tape(4mm Pitch)	φ180mm(7inch)	5,000
MNR14	E0AP	○	○	Paper tape(4mm Pitch)	φ180mm(7inch)	5,000
MNR32	J0AB	○	—	Embossed tape(4mm Pitch)	φ180mm(7inch)	4,000
MNR34	J5AB	○	—	Embossed tape(4mm Pitch)	φ180mm(7inch)	4,000

Reel(φ180mm) : Compatible with JEITA standard "EIAJ ET-7200B"
○ : Standard product

Thick Film Chip Resistors (Standard series) 8-element Chip Resistor Networks (MNR series <0603×5 to 1206×5>)

- One package built in 8-element chip contributes to space-saving
- 8 resistor elements reduce mounting cost
- Convex type electrodes facilitate visual inspection of fillets.
Inspection can be performed with automatic inspection equipment.
- Suitable for pull-up resistor, damping resistor
- No direction to be mounted

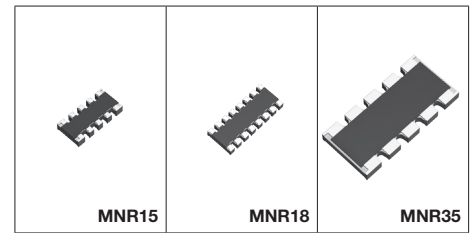

MNR series <0603×5 to 1206×5>										
Part No.	Size Code mm(inch)	No. of Terminals	No. of Elements	Rated Power (70°C)	Limiting Element Voltage (V)	Tolerance	Temperature Coefficient (ppm/°C)	Resistance Range	Operating Temperature (°C)	Automotive Grade AEC-Q200
MNR15	1608 (0603)×5	10	8	0.031W/Element	12.5	J(±5%)	±200	56Ω to 100kΩ(E24 Series)	-55 to +125	Yes
MNR18	1605 (0602)×8	16	8	0.063W/Element*	25	J(±5%)	±200	10Ω to 1MΩ(E24 Series)		Yes
MNR35	3216 (1206)×5	10	8	0.063W/Element	50	J(±5%)	±200	56Ω to 100kΩ(E12 Series)		Yes

*Power for a packing Max. 0.25W

Jumper type					
Part No.	Size Code mm(inch)	Rated Current	Resistance	Operating Temperature(°C)	Automotive Grade AEC-Q200
MNR18	1605(0602)×8	1A/Element	50mΩ Max.	-55 to +125	Yes

Dimensions (Unit : mm)

MNR15

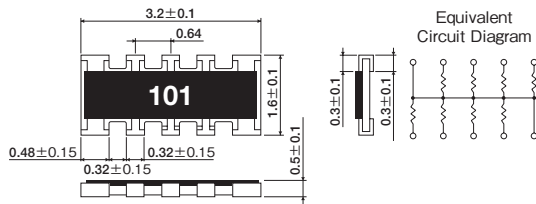

MNR18

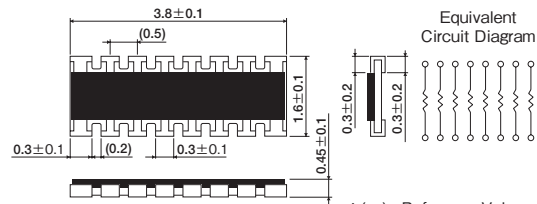

* () : Reference Value

MNR35

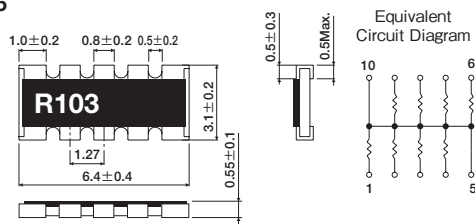

Part No. Explanation

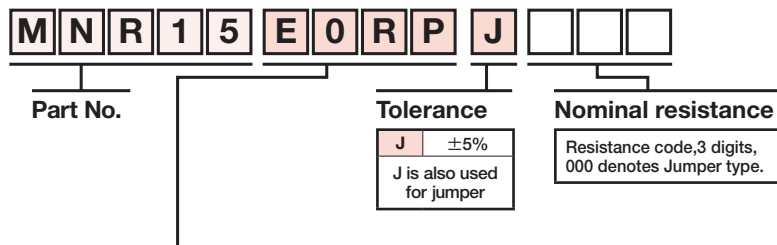

Packaging specifications Code

Part No.	Code	Tolerance J(±5%)	Packaging Specifications	Reel	Basic Ordering Unit (pcs)
MNR15	E0RP	○	Paper tape(4mm Pitch)	φ180mm(7inch)	5,000
MNR18	E0AP	○	Paper tape(4mm Pitch)	φ180mm(7inch)	5,000
MNR35	J5R	○	Embossed tape(4mm Pitch)	φ180mm(7inch)	4,000

Reel(φ180mm) : Compatible with JEITA standard "EIAJ ET-7200B"
○ : Standard product

Thick Film Chip Resistors (High Reliability series)

High Anti-surge Chip Resistors (SDR series)

Anti-surge Chip Resistors (ESR series)

- Exclusive resistive element pattern and laser trimming technology results in significantly improved surge resistance characteristics.
- Superior power ratings.



SDR series								
Part No.	Size Code mm(inch)	Rated Power (70°C)	Limiting Element Voltage (V)	Tolerance	Temperature Coefficient (ppm/°C)	Resistance Range	Operating Temperature (°C)	Automotive Grade AEC-Q200
SDR03	1608 (0603)	0.3W	150	J(±5%)	±200	1Ω to 10MΩ(E24 Series)	-55 to +155	Yes
				F(±1%)	±200 ±100	1Ω to 9.76kΩ(E24, 96 Series) 10Ω to 10MΩ(E24, 96 Series)		
				D(±0.5%)	±100	10Ω to 1MΩ(E24, 96 Series)		
☆SDR10	2012 (0805)	0.50W	200	J(±5%)	±200	1Ω to 10MΩ(E24 Series)		
				F(±1%)	±100	1Ω to 10MΩ(E24, 96 Series)		
				D(±0.5%)	±100	10Ω to 1MΩ(E24, 96 Series)		
ESR series								
ESR01	1005 (0402)	0.2W (1/5W)	50	J(±5%)	+500/-250 ±200	1Ω to 9.1Ω(E24Series) 10Ω to 10MΩ(E24Series)	-55 to +155	Yes
				F(±1%)	±100	10Ω to 976kΩ(E24, 96 Series) 1MΩ to 2.2MΩ(E24 Series)		
ESR03	1608 (0603)	0.25W (1/4W)	150	J(±5%)	±200	1Ω to 10MΩ(E24 Series)		
				F(±1%)	±200 ±100	1Ω to 9.76kΩ(E24, 96 Series) 10Ω to 10MΩ(E24, 96 Series)		
				D(±0.5%)	±100	10Ω to 1MΩ(E24, 96 Series)		
ESR10	2012 (0805)	0.4W (2/5W)	150	J(±5%)	±200	1Ω to 30MΩ(E24 Series)		
				F(±1%)	±100	1Ω to 10MΩ(E24, 96 Series)		
				D(±0.5%)	±100	10Ω to 1MΩ(E24, 96 Series)		
ESR18	3216 (1206)	0.5W (1/2W)	200	J(±5%)	±200	1Ω to 15MΩ(E24 Series)		
				F(±1%)	±100	1Ω to 10MΩ(E24,96 Series)		
				D(±0.5%)	±100	10Ω to 1MΩ(E24,96 Series)		
ESR25	3225 (1210)	0.66W (2/3W)	200	J(±5%)	±200	1Ω to 10MΩ(E24 Series)		
				F(±1%)	±100	1Ω to 10MΩ(E24,96 Series)		
				D(±0.5%)	±100	10Ω to 1MΩ(E24,96 Series)		

☆ : Under Development
 *E24 : Standard products E96 : Custom products

Dimensions (Unit : mm)

Part No.	Size Code mm(inch)	L	W	t	a	b
SDR03	1608(0603)	1.6±0.1	0.8±0.1	0.45±0.1	0.25±0.1	0.25±0.1
SDR10	2012(0805)	2.0±0.1	1.25±0.1	0.55±0.1	0.25±0.1	0.4 ±0.2
ESR01	1005(0402)	1.0±0.05	0.5±0.05	0.35±0.05	0.2±0.1	0.25 ^{+0.05} _{-0.1}
ESR03	1608(0603)	1.6±0.1	0.8±0.1	0.45±0.1	0.3±0.2	0.3 ±0.2
ESR10	2012(0805)	2.0±0.1	1.25±0.1	0.55±0.1	0.3±0.2	0.4 ±0.2
ESR18	3216(1206)	3.2±0.15	1.6±0.15	0.55±0.1	0.3±0.25	0.5 ±0.25
ESR25	3225(1210)	3.2±0.15	2.5±0.15	0.55±0.1	0.3±0.25	0.5 ±0.25

●SDR03/10

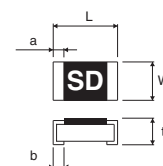

●ESR01/03

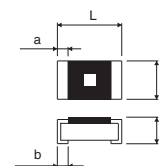

●ESR10/18/25

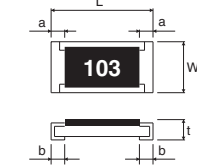

Part No. Explanation

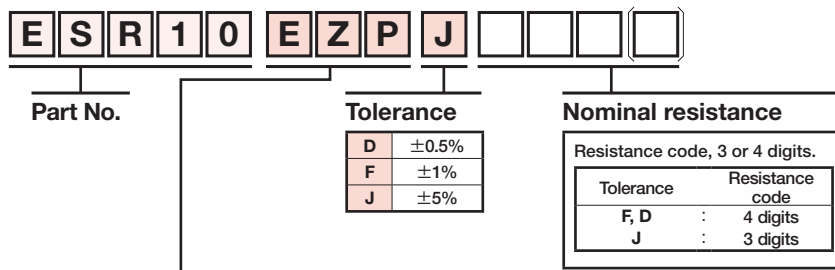

Packaging Specifications Code

Part No.	Code	Tolerance			Packaging Specifications	Reel	Basic Ordering Unit (pcs)
		J(±5%)	F(±1%)	D(±0.5%)			
SDR03	EZP	○	○	○	Paper tape(4mm Pitch)	φ180mm(7inch)	5,000
SDR10	EZP	○	○	○	Paper tape(4mm Pitch)	φ180mm(7inch)	5,000
ESR01	MZP	○	○	—	Paper tape(4mm Pitch)	φ180mm(7inch)	10,000
ESR03	EZP	○	○	○	Paper tape(4mm Pitch)	φ180mm(7inch)	5,000
ESR10	EZP	○	○	○	Paper tape(4mm Pitch)	φ180mm(7inch)	5,000
ESR18	EZP	○	○	○	Paper tape(4mm Pitch)	φ180mm(7inch)	5,000
ESR25	JZP	○	○	○	Embossed tape(4mm Pitch)	φ180mm(7inch)	4,000

Reel(φ180mm) : Compatible with JEITA standard "EIAJ ET-7200B"
 ○ : Standard product

Thick Film Chip Resistors (High Reliability series) High Power Chip Resistors <Wide Terminal type> (LTR series)

- High joint reliability with long side terminations.
- Highest power ratings in their class.
- Guaranteed anti-surge characteristic in all series.

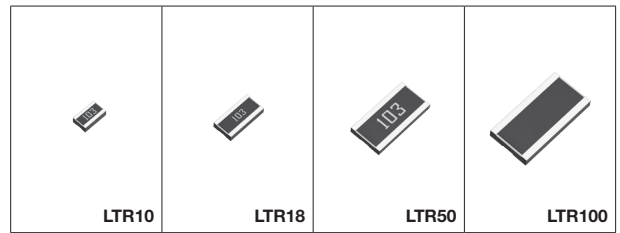

LTR series											
Part No.	Size Code mm(inch)	Rated Power (70°C)	Limiting Element Voltage (V)	Tolerance	Temperature Coefficient (ppm/°C)	Resistance Range	Operating Temperature (°C)	Automotive Grade AEC-Q200			
LTR10	1220 (0508)	0.25W (1/4W)	150	J(±5%)	±200	1Ω to 1MΩ (E24 Series)	-55 to +155	Yes			
				F(±1%)	±100	1Ω to 1MΩ (E24, 96 Series)					
				D(±0.5%)	±100	10Ω to 1MΩ (E24, 96 Series)					
LTR18	1632 (0612)	0.75W (3/4W)	200	J(±5%)	±200	1Ω to 1MΩ (E24 Series)		-55 to +155	Yes		
				F(±1%)	±100	1Ω to 1MΩ (E24, 96 Series)					
				D(±0.5%)	±100	10Ω to 1MΩ (E24, 96 Series)					
LTR50	2550 (1020)	1W	200	J(±5%)	±200	1Ω to 1MΩ (E24 Series)			-55 to +155	Yes	
				F(±1%)	±100	1Ω to 1MΩ (E24, 96 Series)					
				D(±0.5%)	±100	10Ω to 1MΩ (E24, 96 Series)					
LTR100	3264 (1225)	2W	200	J(±5%)	±200	1Ω to 1MΩ (E24 Series)				-55 to +155	Yes
				F(±1%)	±100	1Ω to 1MΩ (E24, 96 Series)					
				D(±0.5%)	±100	10Ω to 1MΩ (E24, 96 Series)					

*E24 : Standard products E96 : Custom products

Dimensions (Unit : mm)

Part No.	Size Code mm(inch)	L	W	t	a	b
LTR10	1220(0508)	1.2±0.1	2.0±0.1	0.55±0.1	0.25±0.1	0.35±0.2
LTR18	1632(0612)	1.6±0.15	3.2±0.15	0.55±0.1	0.3±0.2	0.5±0.2
LTR50	2550(1020)	2.5±0.15	5.0±0.15	0.55±0.1	0.38±0.2	0.9±0.2
LTR100	3264(1225)	3.2±0.15	6.4±0.15	0.55±0.15	0.4±0.25	1.13±0.25

● LTR10/18/50

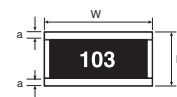

● LTR100 (No marking)

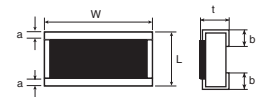

Part No. Explanation

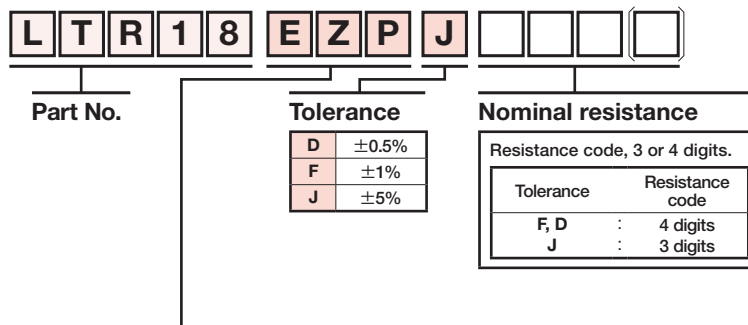

Packaging Specifications Code

Part No.	Code	Tolerance			Packaging Specifications	Reel	Basic Ordering Unit (pcs)
		J(±5%)	F(±1%)	D(±0.5%)			
LTR10	EZP	○	○	○	Paper tape(4mm Pitch)	φ180mm(7inch)	5,000
LTR18	EZP	○	○	○	Paper tape(4mm Pitch)	φ180mm(7inch)	5,000
LTR50	UZP	○	○	○	Embossed tape(4mm Pitch)	φ180mm(7inch)	5,000
LTR100	JZP	○	○	○	Embossed tape(4mm Pitch)	φ180mm(7inch)	4,000

Reel(φ180mm) : Compatible with JEITA standard "EIAJ ET-7200B"
○ : Standard product

Thick Film Chip Resistors (High Reliability series)

High Voltage Resistance Chip Resistors (KTR series)

- Twice the rated voltage of conventional products.
- Perfect for use in Camera Flash circuit, etc.



KTR series								
Part No.	Size Code mm(inch)	Rated Power (70°C)	Limiting Element Voltage (V)	Tolerance	Temperature Coefficient (ppm/°C)	Resistance Range	Operating Temperature (°C)	Automotive Grade AEC-Q200
KTR03	1608 (0603)	0.1W (1/10W)	350	J(±5%)	±200	1Ω to 10MΩ (E24 Series)	-55 to +155	Yes
				F(±1%)	±100	1Ω to 10MΩ (E24, 96 Series)		
KTR10	2012 (0805)	0.125W (1/8W)	400	J(±5%)	±200	1Ω to 30MΩ (E24 Series)		Yes
				F(±1%)	±100	1Ω to 10MΩ (E24, 96 Series)		
KTR18	3216 (1206)	0.25W (1/4W)	500	J(±5%)	±200	1Ω to 15MΩ (E24 Series)		Yes
				F(±1%)	±100	1Ω to 10MΩ (E24, 96 Series)		
KTR25	3225 (1210)	0.33W (1/3W)	600	J(±5%)	±200	1Ω to 10MΩ (E24 Series)		Yes
				F(±1%)	±100	1Ω to 10MΩ (E24, 96 Series)		

*E24 : Standard products E96 : Custom products

Dimensions (Unit : mm)

Part No.	Size Code mm(inch)	L	W	t	a	b
KTR03	1608(0603)	1.6±0.1	0.8±0.1	0.45±0.1	0.3±0.2	0.3±0.2
KTR10	2012(0805)	2.0±0.1	1.25±0.1	0.55±0.1	0.3±0.2	0.4±0.2
KTR18	3216(1206)	3.2±0.15	1.6±0.15	0.55±0.1	0.3±0.25	0.5±0.25
KTR25	3225(1210)	3.2±0.15	2.5±0.15	0.55±0.1	0.3±0.25	0.5±0.25

●KTR03

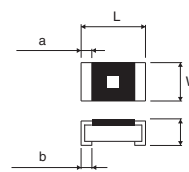

●KTR10/18/25

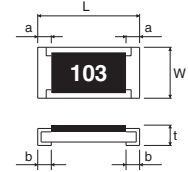

Part No. Explanation

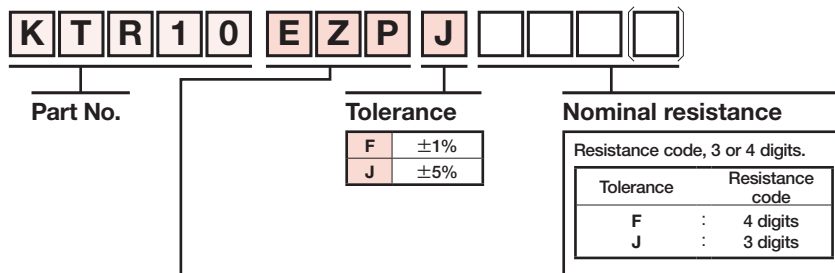

Packaging Specifications Code

Part No.	Code	Tolerance		Packaging Specifications	Reel	Basic Ordering Unit (pcs)
		J(±5%)	F(±1%)			
KTR03	EZP	○	○	Paper tape(4mm Pitch)	φ180mm(7inch)	5,000
KTR10	EZP	○	○	Paper tape(4mm Pitch)	φ180mm(7inch)	5,000
KTR18	EZP	○	○	Paper tape(4mm Pitch)	φ180mm(7inch)	5,000
KTR25	JZP	○	○	Embossed tape(4mm Pitch)	φ180mm(7inch)	4,000

Reel(φ180mm) : Compatible with JEITA standard "EIAJ ET-7200B"
 ○ : Standard product

Thick Film Chip Resistors (High Reliability series) Tolerance for Sulfurization Chip Resistor (SFR series)

- Improved Anti-sulfur reliability by ROHM original structure.

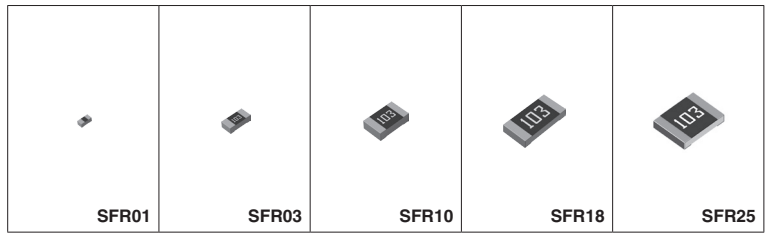

SFR series								
Part No.	Size Code mm(inch)	Rated Power (70°C)	Limiting Element Voltage (V)	Tolerance	Temperature Coefficient (ppm/°C)	Resistance Range	Operating Temperature (°C)	Automotive Grade AEC-Q200
New SFR01	1005 (0402)	0.063W (1/16W)	50	J(±5%)	+500/-250 ±200	1Ω to 9.1Ω (E24 Series) 10Ω to 10MΩ (E24 Series)	-55 to +155	Yes
				F(±1%)	±100	10Ω to 2.2MΩ (E24,96 Series)		
New SFR03	1608 (0603)	0.1W (1/10W)	50	J(±5%)	±400 ±200	1Ω to 9.1Ω (E24 Series) 10Ω to 10MΩ (E24 Series)		Yes
				F(±1%)	±100	10Ω to 10MΩ (E24,96 Series)		
New SFR10	2012 (0805)	0.125W (1/8W)	150	J(±5%)	±400 ±200	1Ω to 9.1Ω (E24 Series) 10Ω to 10MΩ (E24 Series)		Yes
				F(±1%)	±100	10Ω to 2.2MΩ (E24,96 Series)		
☆SFR18	3216 (1206)	0.25W (1/4W)	200	J(±5%)	±400 ±200	1Ω to 9.1Ω (E24 Series) 10Ω to 10MΩ (E24 Series)	Preparing	
				F(±1%)	±100	10Ω to 2.2MΩ (E24,96 Series)		
☆SFR25	3225 (1210)	0.5W (1/2W)	200	J(±5%)	±200	1Ω to 1MΩ (E24 Series)	Preparing	
				F(±1%)	±100	10Ω to 1MΩ (E24, E96 Series)		

☆ : Under Development
*E24 : Standard products E96 : Custom products

Jumper type					
Part No.	Size Code mm(inch)	Rated Current	Resistance	Operating Temperature(°C)	Automotive Grade AEC-Q200
New SFR01	1005(0402)	1A	50mΩ Max.	-55 to +155°C	Yes
New SFR03	1608(0603)	1A			Yes
New SFR10	2012(0805)	2A			Yes
☆SFR18	3216(1206)	2A			Preparing
☆SFR25	3225(1210)	2A			Preparing

☆ : Under Development

Dimensions (Unit : mm)

Part No.	Size Code mm(inch)	L	W	t	a	b
SFR01	1005(0402)	1.0±0.05	0.5±0.05	0.35±0.05	0.33±0.08	0.25 ^{+0.05} _{-0.10}
SFR03	1608(0603)	1.6±0.1	0.8±0.1	0.45±0.1	0.4±0.2	0.3 ±0.2
SFR10	2012(0805)	2.0±0.1	1.25±0.1	0.55±0.1	0.4±0.2	0.4 ±0.2
SFR18	3216(1206)	3.2 ^{+0.15} _{-0.20}	1.6±0.15	0.55±0.1	0.5±0.25	0.5 ±0.25
SFR25	3225(1210)	3.2 ^{+0.15} _{-0.20}	2.5±0.15	0.55±0.1	0.55±0.25	0.5 ±0.25

●SFR01

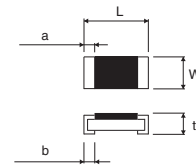

●SFR03/10/18/25

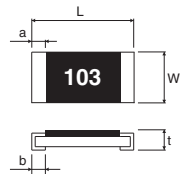

Part No. Explanation

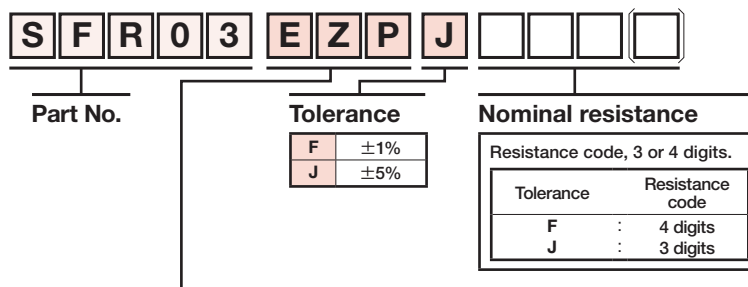

Packaging Specifications Code

Part No.	Code	Tolerance		Packaging Specifications	Reel	Basic Ordering Unit (pcs)
		J(±5%)	F(±1%)			
SFR01	MZP	○	○	Paper tape(2mm Pitch)	φ180mm(7inch)	10,000
SFR03	EZP	○	○	Paper tape(4mm Pitch)	φ180mm(7inch)	5,000
SFR10	EZP	○	○	Paper tape(4mm Pitch)	φ180mm(7inch)	5,000
SFR18	EZP	○	○	Paper tape(4mm Pitch)	φ180mm(7inch)	5,000
SFR25	JZP	○	○	Embossed tape(4mm Pitch)	φ180mm(8inch)	4,000

Reel(φ180mm) : Compatible with JEITA standard "EIAJ ET-7200B"
○ : Standard product

Chip Resistors for Current Detection (Thick Film type)

Chip Resistors (Low Ohmic MCR series)

- Very-low ohmic resistance from 47m Ohm is in lineup by thick-film resistive element.
- High-reliability chip resistor employing metal glaze as resistive element.

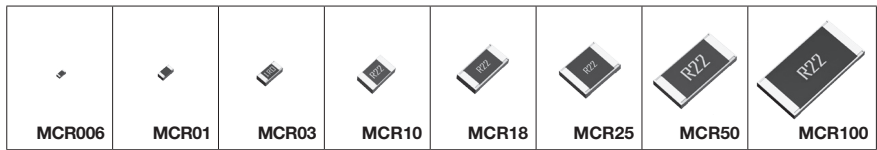

Low Ohmic MCR series							
Part No.	Size Code mm(inch)	Rated Power (70°C)	Tolerance	Temperature Coefficient (ppm/°C)	Resistance Range	Operating Temperature (°C)	Automotive Grade AEC-Q200
MCR006	0603 (0201)	0.05W (1/20W)	F(±1%)	+600/-200	1Ω to 9.1Ω (E24 Series)	-55 to +155	Yes
MCR01	1005 (0402)	0.063W (1/16W)	F(±1%)	±400	1Ω to 9.1Ω (E24 Series)		Yes
MCR03	1608 (0603)	0.1W (1/10W)	F(±1%)	±400	1Ω to 9.1Ω (E24 Series)		Yes
MCR10	2012 (0805)	0.25W (1/4W)	J(±5%)	*Table 1	0.047Ω to 0.91Ω (E24 Series)		Yes
MCR18	3216 (1206)	0.25W (1/4W)	J(±5%)	*Table 1	0.047Ω to 0.91Ω (E24 Series)		Yes
			F(±1%)	*Table 1	0.047Ω to 9.1Ω (E24 Series)		
MCR25	3225 (1210)	0.5W (1/2W)	J(±5%)	300±300	0.047Ω to 0.091Ω (E24 Series)		Yes
			F(±1%)	±200	0.1Ω to 0.91Ω (E24 Series)		
				300±300	0.047Ω to 0.091Ω (E24 Series)		
MCR50	5025 (2010)	0.5W (1/2W)	J(±5%)	*Table 1	0.047Ω to 0.91Ω (E24 Series)		Yes
			F(±1%)	*Table 1	0.047Ω to 9.1Ω (E24 Series)		
MCR100	6432 (2512)	1W	J(±5%)	*Table 1	0.047Ω to 0.91Ω (E24 Series)	-55 to +125	Yes
			F(±1%)	*Table 1	0.047Ω to 9.1Ω (E24 Series)		

*Table 1

Tolerance	Temperature Coefficient (ppm/°C)	Resistance Range
J(±5%) F(±1%)	500±300	0.047Ω to 0.091Ω (E24 Series)
	400±200	0.1Ω to 0.13Ω (E24 Series)
	±250	0.15Ω to 9.1Ω (E24 Series)

Dimensions (Unit : mm)

Part No.	Size Code mm(inch)	L	W	t	a	b
MCR006	0603(0201)	0.6±0.03	0.3±0.03	0.23±0.03	0.1±0.05	0.15±0.05
MCR01	1005(0402)	1.0±0.05	0.5±0.05	0.35±0.05	0.2±0.1	0.25 ^{+0.05} _{-0.1}
MCR03	1608(0603)	1.6±0.1	0.8±0.1	0.45±0.1	0.3±0.2	0.3±0.2
MCR10	2012(0805)	2.0±0.1	1.25±0.1	0.55±0.1	0.4±0.2	0.4±0.2
MCR18	3216(1206)	3.2±0.15	1.6±0.15	0.55±0.1	0.5±0.25	0.5±0.25
MCR25	3225(1210)	3.2±0.15	2.5±0.15	0.55±0.15	0.5±0.25	0.5±0.25
MCR50	5025(2010)	5.0±0.15	2.5±0.15	0.55±0.15	0.6±0.25	0.6±0.25
MCR100	6432(2512)	6.3±0.15	3.2±0.15	0.55±0.15	0.6±0.25	0.6±0.25

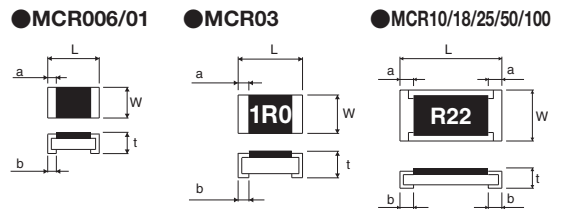

Part No. Explanation

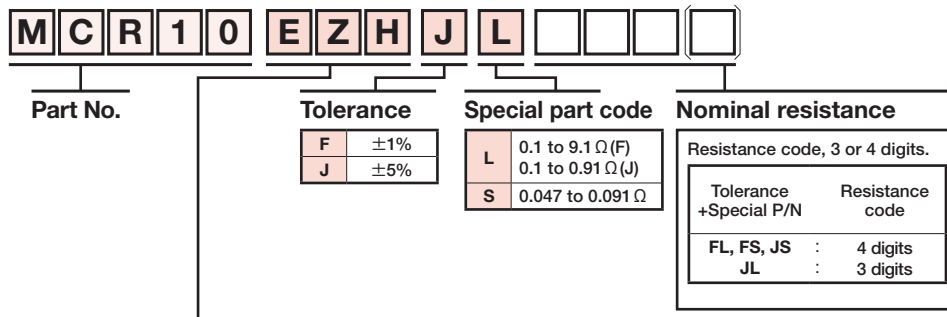

Packaging Specifications Code

Part No.	Code	Tolerance		Packaging Specifications	Reel	Basic Ordering Unit (pcs)
		J(±5%)	F(±1%)			
MCR006	YLP	—	○	Paper tape(2mm Pitch)	φ180mm(7inch)	15,000
MCR01	MZP	—	○	Paper tape(2mm Pitch)	φ180mm(7inch)	10,000
MCR03	EZP	—	○	Paper tape(4mm Pitch)	φ180mm(7inch)	5,000
MCR10	EZH	○	○	Paper tape(4mm Pitch)	φ180mm(7inch)	5,000
MCR18	EZH	○	○	Paper tape(4mm Pitch)	φ180mm(7inch)	5,000
MCR25	JZH	○	○	Embossed tape(4mm Pitch)	φ180mm(7inch)	4,000
MCR50	JZH	○	○	Embossed tape(4mm Pitch)	φ180mm(7inch)	4,000
MCR100	JZH	○	○	Embossed tape(4mm Pitch)	φ180mm(7inch)	4,000

 Reel(φ180mm) : Compatible with JEITA standard "EIAJ ET-7200B"
 ○ : Standard product

Chip Resistors for Current Detection (Thick Film type) Low Ohmic Chip Resistors <Face Down type> (UCR series)

- Chip resistors for current detection. (11mΩ or more)
- Resistive element is located at bottom side, which reduces the resistance shift during mounting process.
- ROHM's unique structure achieved improvement of heat.

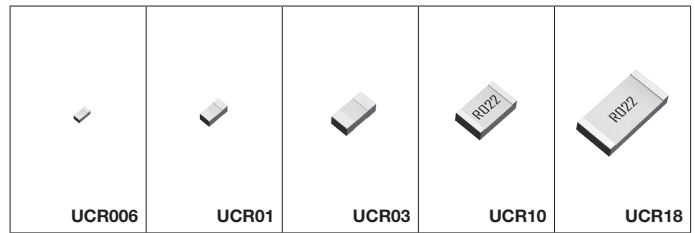

UCR series							
Part No.	Size Code mm(inch)	Rated Power (70°C)	Tolerance	Temperature Coefficient (ppm/°C)	Resistance Range	Operating Temperature (°C)	Automotive Grade AEC-Q200
UCR006	0603 (0201)	0.1W (1/10W)	J(±5%)	0 to 300	100mΩ to 910mΩ (E24 Series)	-55 to +155	Yes
			F(±1%)				
UCR01	1005 (0402)	0.125W (1/8W)	J(±5%)	0 to 300	68mΩ to 91mΩ (E24 Series)		Yes
			F(±1%)	0 to 250	100mΩ to 200mΩ (E24 Series)		
UCR03	1608 (0603)	0.25W (1/4W)	J(±5%)	0 to 250	20mΩ to 47mΩ (E24 Series)		Yes*
			F(±1%)	0 to 200	51mΩ to 91mΩ (E24 Series)		
		0.2W (1/5W)	J(±5%)	0 to 150	100mΩ to 200mΩ (E24 Series)		
			F(±1%)	0 to 150	220mΩ to 910mΩ (E24 Series)		
UCR10	2012 (0805)	0.33W (1/3W)	J(±5%)	250±200	11mΩ to 18mΩ (E24 Series)	Yes	
			F(±1%)	0 to 250	20mΩ to 47mΩ (E24 Series)		
UCR18	3216 (1206)	0.5W (1/2W)	J(±5%)	0 to 350	11mΩ to 18mΩ (E24 Series)	Yes	
			F(±1%)	0 to 200	20mΩ to 39mΩ (E24 Series)		
		☆1.0W	J(±5%)	0 to 350	11mΩ to 18mΩ (E24 Series)	Yes	
			F(±1%)	0 to 200	20mΩ to 39mΩ (E24 Series)		

*Limited to 100mΩ and higher
☆: Under Development

Dimensions (Unit : mm)

Part No.	Size Code mm(inch)	L	W	t	a	b
UCR006	0603(0201)	0.62±0.05	0.32±0.05	0.24±0.05	0.18±0.1	0.22±0.1
UCR01	1005(0402)	1.0±0.1	0.55±0.1	0.37±0.05	0.28±0.1	0.34±0.1
UCR03	1608(0603)	1.6±0.1	0.87±0.1	0.5±0.1	0.45±0.2	0.45±0.2
UCR10	2012(0805)	2.0±0.1	1.25±0.1	0.55±0.1	0.24±0.2	0.5±0.2
UCR18	3216(1206)	3.2±0.15	1.6±0.15	0.55±0.1	0.3±0.2	0.9±0.25

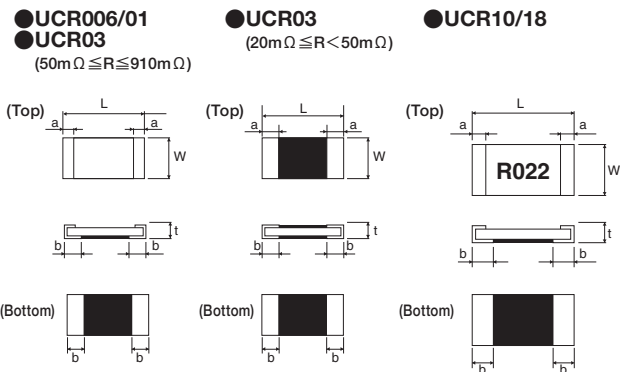

Part No. Explanation

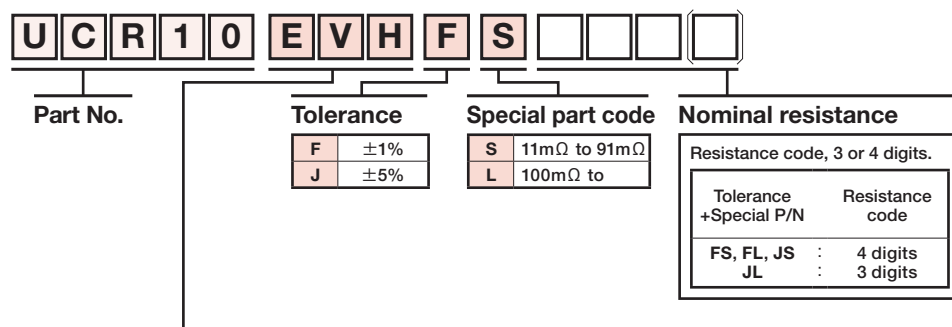

Packaging Specifications Code

Part No.	Code	Tolerance		Packaging Specifications	Reel	Basic Ordering Unit (pcs)	Remarks
		J(±5%)	F(±1%)				
UCR006	YVP	○	○	Paper tape(2mm Pitch)	φ180mm(7inch)	15,000	—
UCR01	MVP	○	○	Paper tape(2mm Pitch)	φ180mm(7inch)	10,000	—
UCR03	EWP	○	○	Paper tape(4mm Pitch)	φ180mm(7inch)	5,000	20mΩ to 47mΩ
	EVP	○	○	Paper tape(4mm Pitch)	φ180mm(7inch)	5,000	51mΩ to 910mΩ
UCR10	EVH	○	○	Paper tape(4mm Pitch)	φ180mm(7inch)	5,000	—
UCR18	EVH	○	○	Paper tape(4mm Pitch)	φ180mm(7inch)	5,000	—

Reel(φ180mm) : Compatible with JEITA standard "EIAJ ET-7200B"E
○ : Standard product

Chip Resistors for Current Detection (Thick Film type) High Power Chip Resistors <Wide Terminal type> (Low Ohmic LTR series)

- Chip resistors for current detection. (10mΩ or more)
- High joint reliability with long side terminations.
- Improvement of rated power enables to displace smaller size of resistors, and it contributes space savings in your set.

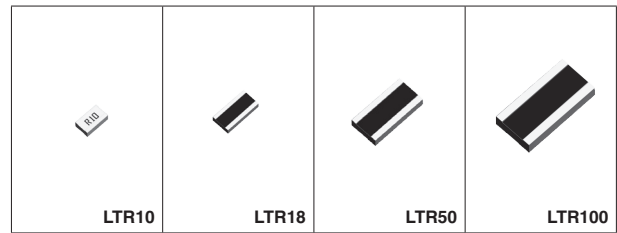

Low Ohmic LTR series							
Part No.	Size Code mm(inch)	Rated Power (70°C)	Tolerance	Temperature Coefficient (ppm/°C)	Resistance Range	Operating Temperature (°C)	Automotive Grade AEC-Q200
LTR10	1220 (0508)	0.5W (1/2W)	J(±5%) F(±1%)	±150	47mΩ to 9.1Ω(E24 Series)	-55 to +155	Yes
LTR18	1632 (0612)	1W	J(±5%) F(±1%)	0 to 300 0 to 200 0 to 150 ±100	10mΩ to 18mΩ(E24 Series) 20mΩ to 47mΩ(E24 Series) 51mΩ to 470mΩ(E24 Series) 510mΩ to 1Ω(E24 Series)		Yes
☆LTR50	2550 (1020)	1.5W	J(±5%) F(±1%)	0 to 300 0 to 200 0 to 150 ±100	10mΩ to 18mΩ(E24 Series) 20mΩ to 47mΩ(E24 Series) 51mΩ to 91mΩ(E24 Series) 100mΩ to 910mΩ(E24 Series)		Preparing
LTR100	3264 (1225)	2W	J(±5%) F(±1%)	±200 0 to 150	100mΩ to 910mΩ(E24 Series) 100mΩ to 910mΩ(E24 Series)		Yes

☆ : Under Development

Dimensions (Unit : mm)

Part No.	Size Code mm(inch)	L	W	t	a	b
LTR10	1220(0508)	1.2±0.1	2.0±0.1	0.55±0.1	0.3±0.2	0.35±0.2
LTR18	1632(0612)	1.6±0.1	3.2±0.1	0.58±0.1	0.5±0.2	0.5±0.2
LTR50	2550(1020)	2.5±0.15	5.0±0.15	0.55±0.15	0.38±0.2	0.9±0.2
LTR100	3264(1225)	3.2±0.15	6.4±0.15	0.55±0.15	0.4±0.25	1.13±0.25

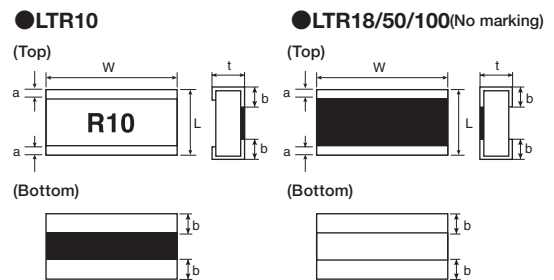

Part No. Explanation

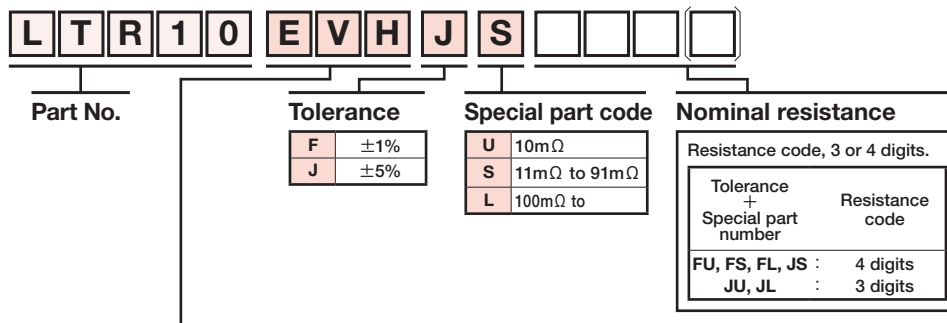

Packaging Specifications Code

Part No.	Code	Tolerance		Packaging Specifications	Reel	Basic Ordering Unit (pcs)
		J(±5%)	F(±1%)			
LTR10	EVH	○	○	Paper tape(4mm Pitch)	φ180mm(7inch)	5,000
LTR18	EZP	○	○	Paper tape(4mm Pitch)	φ180mm(7inch)	5,000
LTR50	UZP	○	○	Embossed tape(4mm Pitch)	φ180mm(7inch)	5,000
LTR100	JZP	○	○	Embossed tape(4mm Pitch)	φ180mm(7inch)	4,000

Reel(φ180mm) : Compatible with JEITA standard "EIAJ ET-7200B"
○ : Standard product

Chip Resistors for Current Detection (Metal Plate type) Ultra Low Ohmic Chip Shunt Resistors (PMR series)

- Ultra low-ohmic resistance range (1mΩ or more)
- Improved current detection accuracy by trimming-less structure.
Highly recommended for large current/
High speed switching circuit.
- Special low resistance temperature coefficient (TCR) alloy utilized for the resistive element.

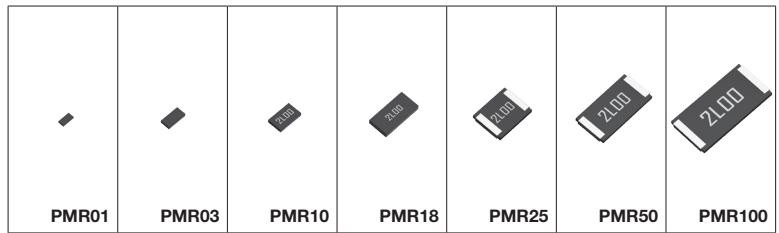

PMR series							
Part No.	Size Code mm(inch)	Rated Power (70°C)	Tolerance	Temperature Coefficient (ppm/°C)	Resistance Value (mΩ)	Operating Temperature (°C)	Automotive Grade AEC-Q200
PMR01	1005(0402)	0.2W (1/5W)	J(±5%)	0 to 200	10	-55 to +155	Yes
PMR03	1608(0603)	0.25W (1/4W)	J(±5%) F(±1%)	0 to 150	10(☆5)		Yes
PMR10	2012(0805)	0.5W (1/2W)	J(±5%) F(±1%)	±150	2,3,4,5,6, 7,8,9,10		Yes
PMR18	3216(1206)	1W	J(±5%) F(±1%)	±100	1,2,3,4,5, 6,7,8,9,10		Yes
PMR25	3225(1210)	1W	J(±5%) F(±1%)	±100	1,2,3,4,5		Yes
PMR50	5025(2010)	1W	J(±5%) F(±1%)	±100	1,2,2.5,3,4,5, 6,7,8,9,10		Yes
PMR100	6432(2512)	2W	J(±5%) F(±1%)	±150	1,2		Yes
		☆3W	J(±5%) F(±1%)	±100	3,4,5,6,7,8,9,10		
			J(±5%) F(±1%)	±150	1,2		

☆ : Under Development

Large current jumper type					
Part No.	Size Code mm(inch)	Rated Current	Resistance	Operating Temperature(°C)	Automotive Grade AEC-Q200
PMR01	1005(0402)	20.0A	0.5mΩ Max.	-55 to +155	Yes
PMR03	1608(0603)	22.4A			Yes
PMR10	2012(0805)	31.6A			Yes
PMR18	3216(1206)	38.7A			Yes
PMR25	3225(1210)	44.7A			Yes
PMR50	5025(2010)	50.0A			Yes
PMR100	6432(2512)	63.2A			Yes

Dimensions (Unit : mm)

Part No.	Size Code mm(inch)	L	W	t	a	b	c
PMR01	1005(0402)	1.0±0.05	0.5±0.05	0.25±0.1	—	0.30±0.10	—
PMR03	1608(0603)	1.6±0.15	0.8±0.15	0.25±0.1	—	0.35±0.15	—
PMR10	2012(0805)	2.0±0.15	1.2±0.15	0.42 to 0.28*±0.15	—	0.75 to 0.35*±0.25	—
PMR18	3216(1206)	3.2±0.15	1.6±0.15	0.42 to 0.28*±0.15	—	1.20 to 0.5 *±0.25	—
PMR25	3225(1210)	3.2±0.2	2.5±0.2	0.52 to 0.32*±0.15	0.5±0.2	1.00 to 0.8 *±0.2	1.95±0.2
PMR50	5025(2010)	5.0±0.2	2.5±0.2	0.52 to 0.32*±0.15	0.5±0.2	1.85 to 0.9 *±0.2	1.95±0.2
PMR100	6432(2512)	6.4±0.25	3.2±0.25	0.52 to 0.32*±0.15	0.5±0.25	2.3 to 1.1 *±0.25	2.65±0.25

* Each value range varies with the resistance. Please contact a ROHM sales representative for further details.

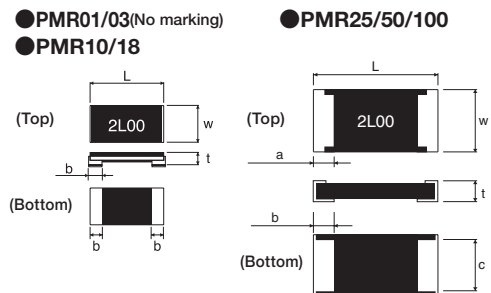

Part No. Explanation



Part No.

Tolerance	
F	±1%
J	±5%

Special part code	
U	5 to 10mΩ
V	1 to 4mΩ

* Jumper type doesn't have a special part code

Nominal resistance

Resistance code, 3 or 4 digits.	
Tolerance	Resistance code
F	: 4 digits
J	: 3 digits

Packaging specifications Code

Part No.	Code	Tolerance		Packaging Specifications	Reel	Basic Ordering Unit (pcs)
		J(±5%)	F(±1%)			
PMR01	ZZP	○	—	Embossed tape(2mm Pitch)	φ180mm(7inch)	10,000
PMR03	EZP	○	○	Paper tape(4mm Pitch)	φ180mm(7inch)	5,000
PMR10	EZP	○	○	Paper tape(4mm Pitch)	φ180mm(7inch)	5,000
PMR18	EZP	○	○	Paper tape(4mm Pitch)	φ180mm(7inch)	5,000
PMR25	HZP	○	○	Embossed tape(4mm Pitch)	φ180mm(7inch)	2,000
PMR50	HZP	○	○	Embossed tape(4mm Pitch)	φ180mm(7inch)	2,000
PMR100	HZP	○	○	Embossed tape(4mm Pitch)	φ180mm(7inch)	2,000

Reel(φ180mm) : Compatible with JEITA standard "EIAJ ET-7200B"
○ : Standard product

Resistance Value(Ω)	Tolerance	
	J	F
Jumper	000	—
1mΩ	1L0	1L00
2mΩ	2L0	2L00
3mΩ	3L0	3L00
4mΩ	4L0	4L00
5mΩ	5L0	5L00
6mΩ	6L0	6L00
7mΩ	7L0	7L00
8mΩ	8L0	8L00
9mΩ	9L0	9L00
10mΩ	10L	10L0

Chip Resistors for Current Detection (Metal Plate type)

Ultra Low Ohmic Chip Shunt Resistors <Wide Terminal type> (PML series)

- Ultra-low resistance range (0.5mΩ or more).
- Wide terminal configuration for high joint reliability.
- Improved current detection accuracy by trimming-less structure.

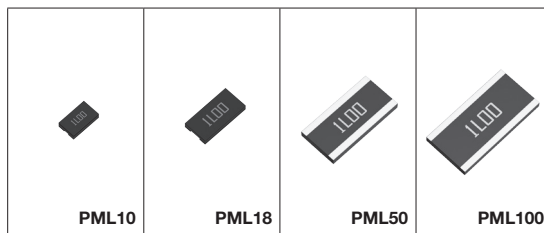

PML series							
Part No.	Size Code mm(inch)	Rated Power (70°C)	Tolerance	Temperature Coefficient (ppm/°C)	Resistance Value (mΩ)	Operating Temperature (°C)	Automotive Grade AEC-Q200
PML10	1220 (0508)	0.66W	J(±5%) G(±2%)	±200	1.0, 1.5, 2.0, 2.5	-55 to +155	Yes
PML18	1632 (0612)	1W	J(±5%) G(±2%)	±150	0.5, 1.0, 1.5, 2.0, 2.5		Yes
PML50	2550 (1020)	2W	J(±5%)	±200	0.5, 2.2		Yes
PML100	3264 (1225)	2W (3W at 25°C)	J(±5%)	±100	1.0, 1.5, 2.0, 2.2		Yes
		2W		±150	0.5		

Dimensions (Unit : mm)

Part No.	Size Code mm(inch)	L	W	t	a	b
PML10	1220(0508)	1.2±0.15	2.0±0.15	0.42±0.15	—	0.45 to 0.3* ±0.2
PML18	1632(0612)	1.6±0.15	3.2±0.15	0.42 to 0.28* ±0.15	—	0.55 to 0.3* ±0.2
PML50	2550(1020)	2.5±0.2	5.0±0.2	0.5 to 0.36* ±0.15	0.4±0.2	0.75 to 0.7* ±0.2
PML100	3264(1225)	3.2±0.25	6.4±0.25	0.5 to 0.36* ±0.15	0.45±0.25	0.9 to 0.7* ±0.25

* Each value range varies with the resistance. Please contact a ROHM sales representative for further details.

● PML10/18

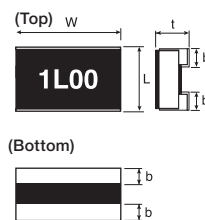

● PML50/100

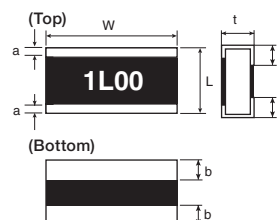

Part No. Explanation



Part No.

Tolerance

G	±2%
J	±5%

Special part code

Nominal resistance

Resistance code, 3 or 4 digits.	
Tolerance	Resistance code
J	: 3 digits
G	: 4 digits

Resistance Value(Ω)	Tolerance	
	J	G
0.5mΩ	0L5	0L50
1mΩ	1L0	1L00
1.5mΩ	1L5	1L50
2mΩ	2L0	2L00
2.2mΩ	2L2	—
2.5mΩ	2L5	2L50

Packaging Specifications Code

Part No.	Code	Tolerance		Packaging Specifications	Reel	Basic Ordering Unit (pcs)
		J(±5%)	G(±2%)			
PML10	EZP	○	○	Paper tape(4mm Pitch)	φ180mm(7inch)	5,000
PML18	EZP	○	○	Paper tape(4mm Pitch)	φ180mm(7inch)	5,000
PML50	HZP	○	—	Embossed tape(4mm Pitch)	φ180mm(7inch)	2,000
PML100	HZP	○	—	Embossed tape(4mm Pitch)	φ180mm(7inch)	2,000

Reel(φ180mm) : Compatible with JEITA standard "EIAJ ET-7200B"
 ○ : Standard product

Chip Resistors for Current Detection (Metal Plate type) High Power Ultra Low Ohmic Chip Shunt Resistors (PSR series)

- High power 3W to 5W
- Ultra low resistance range (0.1mΩ or more).
- Excellent TCR characteristics
- Convex structure

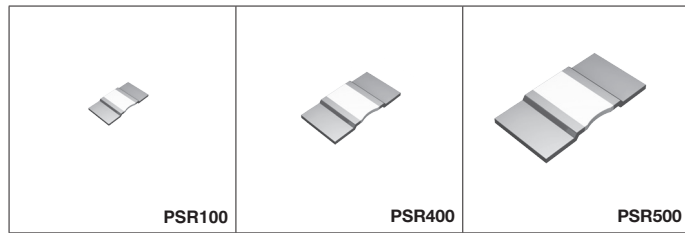

PSR series							
Part No.	Size Code mm(inch)	Rated Power (70°C)	Tolerance	Temperature* coefficient (ppm/°C)	Resistance Range (mΩ)	Operating Temperature (°C)	Automotive Grade AEC-Q200
New PSR100	6432 (2512)	3W	F(±1%)	±150	0.3	-55 to +170	Yes
				±115	0.5		
				±100	1.0		
				±50	2.0, 3.0		
PSR400	10×5.2 (3921)	4W	F(±1%)	125±50	☆0.2		
				±175	0.3, 0.5		
				±75	1.0, 2.0, 3.0		
				200±50	☆0.1		
PSR500	15×7.75 (5931)	5W	F(±1%)	±225	0.2		
				±150	0.3, 0.4, 0.5		
				±75	1.0, 2.0		

* (+20°C to +125°C)
☆ : Under Development

Dimensions (Unit : mm)

Part No.	Resistance	L	W	t	H	b
PSR100	0.3mΩ	6.35±0.15	3.05±0.25	1.45±0.15	0.35±0.15	1.12±0.3
	0.5mΩ			1.15±0.15		
	1.0mΩ			0.75±0.15		
	2.0mΩ			1.00±0.15		
	3.0mΩ			0.75±0.15		
PSR400	☆0.2mΩ	10±0.3	5.2±0.3	1.96±0.15	0.5±0.15	2.0±0.6
	0.3mΩ			1.85±0.15		
	0.5mΩ			1.3±0.15		
	1.0mΩ			0.9±0.15		
	2.0mΩ			1.1±0.15		
PSR500	☆0.1mΩ	15±0.3	7.75±0.3	1.9±0.15	0.5±0.15	4.0±0.6
	0.2mΩ			1.85±0.15		
	0.3mΩ			1.4±0.15		
	0.4mΩ			1.15±0.15		
	0.5mΩ			1.05±0.15		
	1.0mΩ			1.35±0.15		
	2.0mΩ			0.9±0.15		

☆ : Under Development

PSR100/400/500

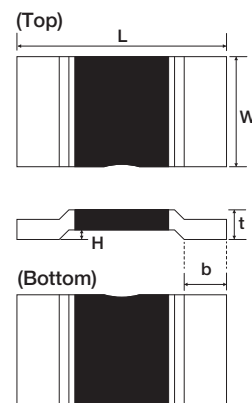

Part No. Explanation



Part No.

Tolerance

Special part code

Nominal resistance

F 1%

B	0.1mΩ
C	0.2mΩ
D	0.3mΩ
E	0.4mΩ
F	0.5mΩ
H	1.0mΩ
J	2.0mΩ
L	3.0mΩ

Resistance code, 4 digits.	
Tolerance	Resistance code
F	: 4 digits
Resistance	F
0.1mΩ	0L10
0.2mΩ	0L20
0.3mΩ	0L30
0.4mΩ	0L40
0.5mΩ	0L50
1.0mΩ	1L00
2.0mΩ	2L00
3.0mΩ	3L00

Packaging Specifications Code

Part No.	Code	Tolerance F(±1%)	Packaging Specifications	Reel	Basic Ordering Unit (pcs)
PSR100	KTQ	○	Embossed tape(8mm Pitch)	φ 330mm(13inch)	5,000
PSR400	ITQ	○	Embossed tape(8mm Pitch)	φ 330mm(13inch)	3,000
PSR500	HTQ	○	Embossed tape(12mm Pitch)	φ 330mm(13inch)	2,000

Reel(φ330mm) : Compatible with JEITA standard "EIAJ ET-7200B"
○ : Standard product

Chip Resistors for Current Detection (Metal Plate type) High Power Low Ohmic Chip Shunt Resistors (GMR series)

- High power (2W to 5W)
- High heat dissipation
- Excellent TCR characteristics
- Low ohmic (5mΩ to 220mΩ)

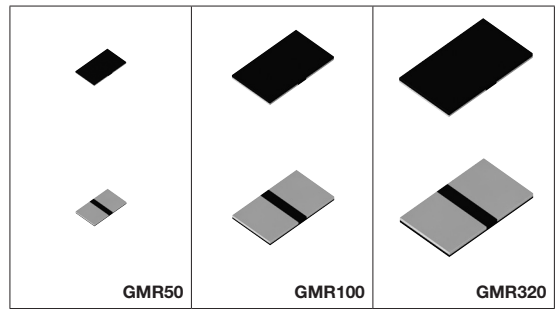

GMR series							
Part No.	Size Code mm(inch)	Rated Power (70°C)	Tolerance	Temperature ^{*1} Coefficient (ppm/°C)	Resistance Range (mΩ)	Operating Temperature (°C)	Automotive Grade AEC-Q200
☆GMR50	5025 (2010)	2W	F(±1%)	0 to +50 ±25	5mΩ 10mΩ to 200mΩ (E6 Series ^{*2*3})	-55 to +170	Preparing
New GMR100	6432 (2512)	3W	F(±1%)	0 to +50 ±20	☆5mΩ 10mΩ to 220mΩ (E6 Series ^{*2})		Yes
☆GMR320	7142 (2817)	5W	F(±1%)	0 to +100 ±25	5mΩ 10mΩ to 100mΩ (E6 Series ^{*2*3})		Preparing

*1 (+20°C to +60°C)
*2 Please contact us for another standard nominal resistance values.
*3 Development schedule will vary depending on resistance value.
☆ : Under Development (Development schedule will vary depending on resistance value. Please Contacts us.)

Dimensions (Unit : mm)

Part No.	Size Code mm(inch)	L	w	t	b
GMR50	5025 (2010)	5.00±0.25	2.50±0.25	0.40±0.15	2.05±0.25
GMR100	6432 (2512)	6.40±0.25	3.20±0.25	0.40±0.15	2.75±0.25
GMR320	7142 (2817)	7.10±0.25	4.20±0.25	0.40±0.15	3.10±0.25

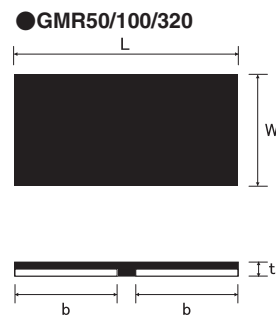

Part No. Explanation



Part No.	Special part code I	Tolerance	Special part code II	Nominal resistance																																												
	<table border="1"> <tr><td>TB</td><td>10mΩ to 68mΩ</td></tr> <tr><td>TC</td><td>100mΩ to 220mΩ</td></tr> </table>	TB	10mΩ to 68mΩ	TC	100mΩ to 220mΩ	<table border="1"> <tr><td>F</td><td>±1%</td></tr> </table>	F	±1%	<table border="1"> <tr><td>A</td><td>10mΩ, 100mΩ</td></tr> <tr><td>E</td><td>15mΩ, 150mΩ</td></tr> <tr><td>I</td><td>22mΩ, 220mΩ</td></tr> <tr><td>M</td><td>33mΩ</td></tr> <tr><td>Q</td><td>47mΩ</td></tr> <tr><td>U</td><td>68mΩ</td></tr> </table>	A	10mΩ, 100mΩ	E	15mΩ, 150mΩ	I	22mΩ, 220mΩ	M	33mΩ	Q	47mΩ	U	68mΩ	<p>Resistance code, 4 digits.</p> <table border="1"> <thead> <tr> <th>Tolerance</th> <th>Resistance code</th> </tr> </thead> <tbody> <tr> <td>F</td> <td>: 4 digits</td> </tr> </tbody> </table> <table border="1"> <thead> <tr> <th>Resistance</th> <th>F</th> </tr> </thead> <tbody> <tr><td>5mΩ</td><td>5L00</td></tr> <tr><td>10mΩ</td><td>10L0</td></tr> <tr><td>15mΩ</td><td>R015</td></tr> <tr><td>22mΩ</td><td>R022</td></tr> <tr><td>33mΩ</td><td>R033</td></tr> <tr><td>47mΩ</td><td>R047</td></tr> <tr><td>68mΩ</td><td>R068</td></tr> <tr><td>100mΩ</td><td>R100</td></tr> <tr><td>150mΩ</td><td>R150</td></tr> <tr><td>220mΩ</td><td>R220</td></tr> </tbody> </table>	Tolerance	Resistance code	F	: 4 digits	Resistance	F	5mΩ	5L00	10mΩ	10L0	15mΩ	R015	22mΩ	R022	33mΩ	R033	47mΩ	R047	68mΩ	R068	100mΩ	R100	150mΩ	R150	220mΩ	R220
TB	10mΩ to 68mΩ																																															
TC	100mΩ to 220mΩ																																															
F	±1%																																															
A	10mΩ, 100mΩ																																															
E	15mΩ, 150mΩ																																															
I	22mΩ, 220mΩ																																															
M	33mΩ																																															
Q	47mΩ																																															
U	68mΩ																																															
Tolerance	Resistance code																																															
F	: 4 digits																																															
Resistance	F																																															
5mΩ	5L00																																															
10mΩ	10L0																																															
15mΩ	R015																																															
22mΩ	R022																																															
33mΩ	R033																																															
47mΩ	R047																																															
68mΩ	R068																																															
100mΩ	R100																																															
150mΩ	R150																																															
220mΩ	R220																																															

*Product No. of 5mΩ is an exception.
GMR50HTAAFD5L00
GMR100HTAAFD5L00
GMR320HTAAFD5L00

包装仕様記号

Part No.	Code	Tolerance F(±1%)	Packaging Specifications	Reel	Basic Ordering Unit (pcs)
GMR50	H	☆	Embossed tape(4mm Pitch)	φ180mm	2,000
GMR100	H	◎	Embossed tape(8mm Pitch)	φ180mm	2,000
GMR320	H	☆	Embossed tape(8mm Pitch)	φ180mm	2,000

☆ : Under Development
Reel(φ180mm) : Compatible with JEITA standard "EIAJ ET-7200B"
◎ : Standard product

Standard Nominal Resistance Values

E3	10				22						47						
E6	10		15		22		33		47		68						
E12	10	12	15	18	22	27	33	39	47	56	68	82					
E24	10	11	12	13	15	16	18	20	22	24	27	30	33	36	39	43	47
	51	56	62	68	75	82	91										
E96	100	102	105	107	110	113	115	118	121	124	127	130	133	137	140	143	147
	150	154	158	162	165	169	174	178	182	187	191	196	200	205	210	215	221
	226	232	237	243	249	255	261	267	274	280	287	294	301	309	316	324	332
	340	348	357	365	374	383	392	402	412	422	432	442	453	464	475	487	499
	511	523	536	549	562	576	590	604	619	634	649	665	681	698	715	732	750
	768	787	806	825	845	866	887	909	931	953	976						

Nominal Resistance

Resistors of a series fall into one of nominal resistance ranges shown in the table above. Nominal resistance is determined by the common ratio shown right.

Resistance Coding

Nominal resistance is expressed in 3 digits when the resistance tolerance is $\pm 5\%$ and in 4 digits when $\pm 1\%$.

The leading 2 or 3 digits indicate significant figure while the last digit indicates the number of zeros. The letter R or L denotes the decimal point if necessary.

Ex.1 $22\Omega \rightarrow 22 \times 10^0\Omega \rightarrow 220$ (the last digit indicates the number "0" of a multiplier)

Ex.2 $47k\Omega \rightarrow 47 \times 10^3\Omega \rightarrow 473$ (the last digit indicates the number "3" of a multiplier)

Ex.3 $1.2M\Omega \rightarrow 12 \times 10^5\Omega \rightarrow 125$ (the last digit indicates the number "5" of a multiplier)

Ex.4 $2.7\Omega \rightarrow 2R7$ (the decimal point indicate the letter R/the letter R apply to the low Resistance less than 10Ω)

Ex.5 $1130\Omega \rightarrow 113 \times 10^1\Omega \rightarrow 1131$ (the last digit indicates the number "1" of a multiplier/Resistance Tolerance 1%(F) products)

Ex.6 $0.10\Omega \rightarrow R10$

Ex.7 $1m\Omega \rightarrow 1L0$

Series	Common ratio	Remarks
E6	$\sqrt[6]{10} \approx 1.46$	Rounded off to a 2-digit figure.
E12	$\sqrt[12]{10} \approx 1.21$	
E24	$\sqrt[24]{10} \approx 1.10$	
E96	$\sqrt[96]{10} \approx 1.02$	Rounded off to a 3-digit figure.

Supplement of Rated Power

When the ambient temperature exceeds the rated ambient temperature, derate the load power based on the derating curve.

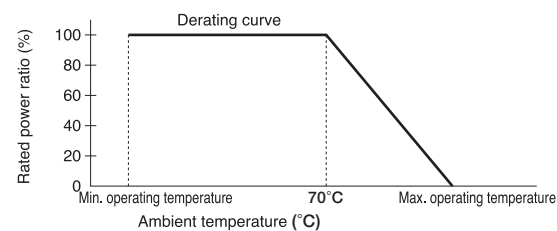

(PSR100, GMR100)

When the terminal temperature with load exceeds the rated terminal temperature(PSR100:140°C, GMR100:110°C), derate the load power based on the derating curve.

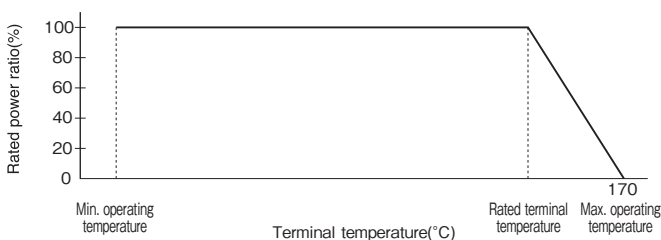

Supplementary to Notes

* 1 : When resistor is to be exposed to a transient load (excessive large load, such as pulse), mount the resistor on your product and check the condition and evaluate the result. Constant application of a voltage above the rated voltage will degrade the performance and reliability of the resistor.

Do not apply a voltage exceeding the rated voltage across any ROHM resistors.

* 2 : Rated voltage(V) $= \sqrt{\text{rated power(W)} \times \text{nominal resistance}(\Omega)}$ or the limiting element voltage, whichever smaller, is the rated voltage.

For basic guidelines on using resistors, see the technical reports issued by Japan Electronics and Information Technology Industries Association. JEITA RCR-2121A. "Guideline of notabilia for fixed resistors for use in electronic equipment (Safety Application Guide for fixed resistors for use in electronic equipment)"



Passive Devices

Tantalum Capacitors

CONTENTS

Conductive Polymer Capacitors

- **New Bottom Surface Electrode(Extra Large Capacitance) : TCSO series** P. D22
 - M case : 1608-10(0603)size
 - PS case : 2012-09(0805)Ultra-Low Profile size
 - PL case : 2012-10(0805)Low Profile size
 - P case : 2012-12(0805)size
- **Bottom Surface Electrode(Large Capacitance) : TCTO series** P. D23,24
 - U2 case : 1005-064(0402)size P. D23
 - M case : 1608-09(0603)size P. D23
 - PL case : 2012-10(0805)Low Profile size P. D23
 - P case : 2012-12(0805)size P. D23
 - AS case : 3216-10(1206)Ultra-Low Profile size P. D24
 - AL case : 3216-12(1206)Low Profile size P. D24
 - A case : 3216-18(1206)size P. D24
 - BL case : 3528-12(1411)Low Profile size P. D24
- **Standard : TCO series** P. D25
 - B case : 3528-21(1411)size

Tantalum Capacitors

- **New Bottom Surface Electrode(Extra Large Capacitance) : TCS series** P. D26
 - M case : 1608-10(0603)size
 - PS case : 2012-09(0805)Ultra-Low Profile size
 - P case : 2012-12(0805)size
- **Bottom Surface Electrode(Large Capacitance) : TCT, TC series** P. D27,28
 - U case : 1005-055(0402)size P. D27
 - ML case : 1608-06(0603)Low Profile size P. D27
 - M case : 1608-09(0603)size P. D27
 - PL case : 2012-10(0805)Low Profile size P. D28
 - P case : 2012-12(0805)size P. D28
 - AS case : 3216-10(1206)Ultra-Low Profile size P. D28
 - AL case : 3216-12(1206)Low Profile size P. D28
- **Standard : TC series** P. D29
 - P case : 2012-12(0805)size
 - A case : 3216-18(1206)size

Conductive Polymer New Bottom Surface Electrode(Extra Large Capacitance) : TCSO series

- M case : 1608-10(0603)size
- PS case : 2012-09(0805)Ultra-Low Profile size
- PL case : 2012-10(0805)Low Profile size
- P case : 2012-12(0805)size

Dimensions

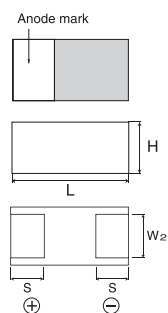
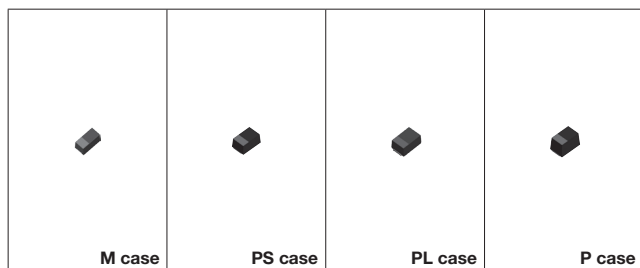

(Unit : mm)

Dimensions	Size			
	M case	PS case	PL case	P case
L	1.6+0.2/-0	2.0±0.2	2.0±0.2	2.0±0.2
W ¹	0.85±0.1	1.25±0.2	1.25±0.2	1.25±0.2
W ²	0.55±0.1	0.85±0.2	0.85±0.2	0.85±0.2
H	0.8+0.2/-0	0.8±0.1	0.9±0.1	Max. 1.2
S	0.5±0.1	0.5±0.1	0.5±0.1	0.5±0.1

Series Name	Case Name	Capacitance Tolerance	Operating Temperature	Tangent of Loss Angle	Leakage Current	ESR
TCSO series	M case 1608-10 (0603)size	±20%(M)	-55°C to +105°C Rated Voltage at -55°C to +85°C DeRated Voltage at +85°C to +105°C	Max. 15% at 120Hz(25°C)*	Max. 0.1 CV (25°C, 5 min.)	Max. 300mΩ(at 100kHz)*
	PS case 2012-09 (0805)Ultra-Low Profile size					Max. 200mΩ(at 100kHz)*
	PL case 2012-10 (0805)Low Profile size					Max. 500mΩ(at 100kHz)*
	P case 2012-12 (0805)size					Max. 400mΩ(at 100kHz)*

*Spec. values are specified for each parts number.

Capacitance Range

- M case : 1608-10(0603)size (ESR : mΩ)

Capacitance (μF)	Rated Voltage(V.DC)			
	2.5	4	6.3	10
10 (106)				☆300
22 (226)			300	
47 (476)			300	

☆:Under Development

- PS case : 2012-09(0805)Ultra-Low Profile size (ESR : mΩ)

Capacitance (μF)	Rated Voltage(V.DC)		
	4	6.3	10
10 (106)			
22 (226)			
47 (476)		150/200	
100 (107)			

- PL case : 2012-10(0805)Low Profile size (ESR : mΩ)

Capacitance (μF)	Rated Voltage(V.DC)					
	4	6.3	10	16	20	25
4.7 (475)						500
10 (106)						
22 (226)			200			
33 (336)			☆200			
47 (476)		150/200				
68 (686)		☆150/☆200				

☆:Under Development

- P case : 2012-12(0805)size (ESR : mΩ)

Capacitance (μF)	Rated Voltage(V.DC)			
	4	6.3	10	16
10 (106)				
22 (226)				☆400
47 (476)			☆200	
100 (107)				

☆:Under Development

*Usage precaution : Based on JEITA Technical Report "EIAJ RCR-2368A"

Conductive Polymer Bottom Surface Electrode(Large Capacitance) : TCTO series

- U2 case : 1005-064(0402)size
- M case : 1608-09(0603)size
- PL case : 2012-10(0805)Low Profile size
- P case : 2012-12(0805)size

■ Dimensions

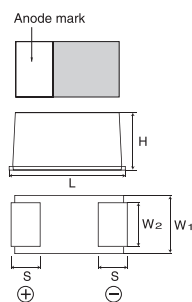
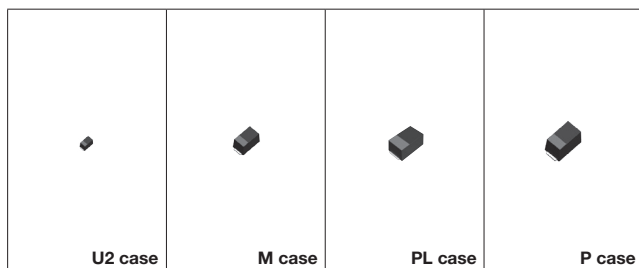

(Unit : mm)

Dimensions	Size			
	U2 case	M case	PL case	P case
L	1.0+0.3/-0	1.6±0.1	2.0±0.2	2.0±0.2
W ¹	0.5+0.2/-0	0.85±0.1	1.25±0.2	1.25±0.2
W ²	0.35±0.1	0.55±0.1	0.85±0.2	0.85±0.2
H	Max. 0.64	0.8±0.1	0.9±0.1	Max. 1.2
S	0.35±0.1	0.5±0.1	0.5±0.2	0.5±0.2

Series Name	Case Name	Capacitance Tolerance	Operating Temperature	Tangent of Loss Angle	Leakage Current	ESR
TCTO series	U2 case 1005-064 (0402)size	±20%(M)	-55°C to +105°C Rated Voltage at -55°C to +85°C DeRated Voltage at +85°C to +105°C	Max. 30% at 120Hz(25°C)*	3μA or 0.1CV whichever is greater (25°C, 5 min.)	Max. 700mΩ(at 100kHz)*
	M case 1608-09 (0603)size			Max. 8% at 120Hz(25°C)*	Max. 0.1 CV (25°C, 5 min.)	Max. 500mΩ(at 100kHz)*
	PL case 2012-10 (0805)Low Profile size			Max. 15% at 120Hz(25°C)*	3μA or 0.1CV whichever is greater (25°C, 5 min.)	Max. 300mΩ(at 100kHz)*
	P case 2012-12 (0805)size					

*Spec. values are specified for each parts number.

■ Capacitance Range

● U2 case : 1005-064(0402)size (ESR : mΩ)

Capacitance (μF)	Rated Voltage(V.DC)			
	2.5	4	6.3	10
0.47 (474)				
1 (105)				
2.2 (225)				
4.7 (475)			☆700	

☆:Under Development

● M case : 1608-09(0603)size (ESR : mΩ)

Capacitance (μF)	Rated Voltage(V.DC)			
	2.5	4	6.3	10
2.2 (225)				500
3.3 (335)				500
4.7 (475)				500
10 (106)			☆500	

☆:Under Development

● PL case : 2012-10(0805)Low Profile size (ESR : mΩ)

Capacitance (μF)	Rated Voltage(V.DC)			
	2.5	4	6.3	10
10 (106)			☆300	
22 (226)			300	
47 (476)				
100 (107)				

☆:Under Development

● P case : 2012-12(0805)size (ESR : mΩ)

Capacitance (μF)	Rated Voltage(V.DC)			
	2.5	4	6.3	10
10 (106)				300
22 (226)				☆300
47 (476)		300		
100 (107)				

☆:Under Development

*Usage precaution : Based on JEITA Technical Report "EIAJ RCR-2368A"

Conductive Polymer Bottom Surface Electrode(Large Capacitance) : TCTO series

- AS case : 3216-10(1206)Ultra-Low Profile size
- AL case : 3216-12(1206)Low Profile size
- A case : 3216-18(1206)size
- BL case : 3528-12(1411)Low Profile size

■ Dimensions

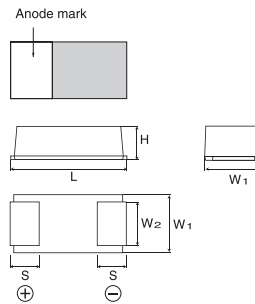
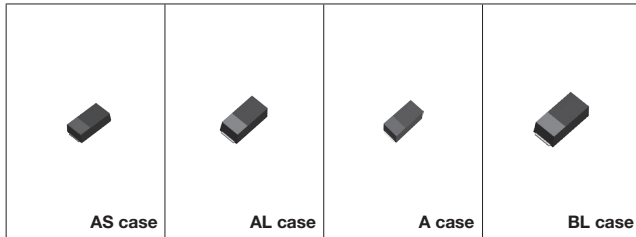

(Unit : mm)

Dimensions	Size			
	AS case	AL case	A case	BL case
L	3.2±0.2	3.2±0.2	3.2±0.2	3.5±0.2
W ¹	1.6±0.2	1.6±0.2	1.6±0.2	2.8±0.2
W ²	1.2±0.2	1.2±0.2	1.2±0.2	2.0±0.2
H	0.9±0.1	1.1±0.1	1.6±0.2	1.1±0.1
S	0.8±0.2	0.8±0.2	0.8±0.2	0.8±0.2

Series Name	Case Name	Capacitance Tolerance	Operating Temperature	Tangent of Loss Angle	Leakage Current	ESR
TCTO series	AS case 3216-10 (1206)Ultra-Low Profile size	±20%(M)	-55°C to +105°C Rated Voltage at -55°C to +85°C DeRated Voltage at +85°C to +105°C	Max. 10% at 120Hz(25°C)*	3μA or 0.1CV whichever is greater (25°C, 5 min.)	Max. 400mΩ(at 100kHz)*
	AL case 3216-12 (1206)Low Profile size			Max. 15% at 120Hz(25°C)*		
	A case 3216-18 (1206)size			Max. 0.2 CV (25°C, 5 min.)	Max. 150mΩ(at 100kHz)*	
	BL case 3528-12 (1411)Low Profile size					

*Spec. values are specified for each parts number.

■ Capacitance Range

- AS case : 3216-10(1206)Ultra-Low Profile size (ESR : mΩ)

Capacitance (μF)	Rated Voltage(V.DC)			
	4	6.3	10	16
22 (226)				
47 (476)		200	100/200	
100 (107)		55/70		

- AL case : 3216-12(1206)Low Profile size (ESR : mΩ)

Capacitance (μF)	Rated Voltage(V)				
	4	6.3	10	16	20
22 (226)			200	☆400	☆400
33 (336)			200		
47 (476)		70/200			
100 (107)	200	70/200			

☆:Under Development

- A case : 3216-18(1206)size (ESR : mΩ)

Capacitance (μF)	Rated Voltage(V)			
	2.5	6.3	10	16
10 (106)				☆200
47 (476)			200	
100 (107)		☆35/45/70		
150 (157)		☆35/200		
220 (227)	35			
330 (337)	☆35/☆200			

☆:Under Development

- BL case : 3528-12(1411)Low Profile size (ESR : mΩ)

Capacitance (μF)	Rated Voltage(V.DC)					
	4	6.3	10	16	25	35
6.8 (685)						150
10 (106)					☆100	☆150
15 (156)					☆100	
22 (226)					☆100	
33 (336)				70		
47 (476)			☆70	☆70		
100 (107)		☆25/☆35				
150 (157)		25/35				
220 (227)		☆25/☆35				

☆:Under Development

*Usage precaution : Based on JEITA Technical Report "EIAJ RCR-2368A"

Conductive Polymer Standard : TCO series

■ B case : 3528-21(1411)size

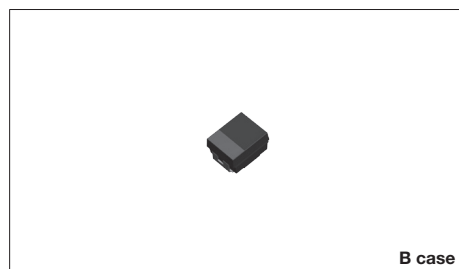

■ Dimensions

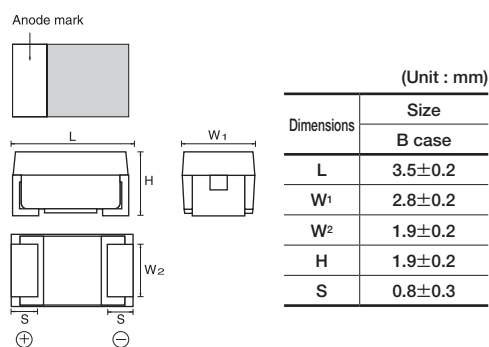

Series Name	Case Name	Capacitance Tolerance	Operating Temperature	Tangent of Loss Angle	Leakage Current	ESR
TCO series	B case 3528-21 (1411)size	±20%(M)	-55°C to +105°C Rated Voltage at -55°C to +85°C DeRated Voltage at +85°C to +105°C	Max. 15% at 120Hz(25°C)*	Max. 0.1 CV (25°C, 5 min.)	Max. 150mΩ(at 100kHz)*

*Spec. values are specified for each parts number.

■ Capacitance Range

● B case : 3528-21(1411)size

(ESR : mΩ)

Capacitance (μF)	Rated Voltage(V.DC)					
	2.5	4	6.3	10	16	25
15 (156)						100
33 (336)				150	100	
47 (476)			70/150	150		
100 (107)			35/45/150			
150 (157)			35/45/150			
220 (227)	35		35/45/150			
330 (337)	35/45					

New Bottom Surface Electrode(Extra Large Capacitance) : TCS series

■ M case : 1608-10(0603)size

■ PS case : 2012-09(0805)Ultra-Low Profile size

■ P case : 2012-12(0805)size

■ Dimensions

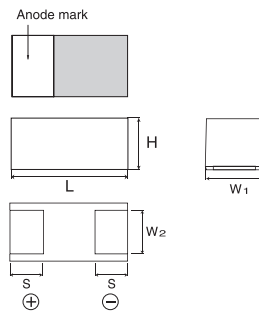
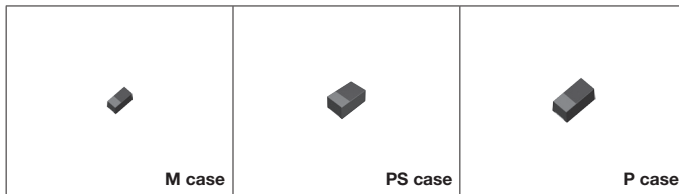

(Unit : mm)

Dimensions	Size		
	M case	PS case	P case
L	1.6+0.2/-0	2.0±0.2	2.0±0.2
W ¹	0.85±0.1	1.25±0.2	1.25±0.2
W ²	0.55±0.1	0.85±0.2	0.85±0.2
H	0.8+0.2/-0	Max. 0.9	Max. 1.2
S	0.5±0.1	0.5±0.1	0.5±0.1

Series Name	Case Name	Capacitance Tolerance	Operating Temperature	Tangent of Loss Angle	Leakage Current	ESR
TCS series	M case 1608-10 (0603)size	±20%(M)	-55°C to +125°C Rated Voltage at -55°C to +85°C DeRated Voltage at +85°C to +125°C	Max. 40% at 120Hz(25°C)*	Max. 0.2 CV (25°C, 5 min.)*	Max. 6.0Ω(at 100kHz)*
	PS case 2012-09 (0805) Ultra-Low Profile size				Max. 0.1 CV (25°C, 5 min.)*	
	P case 2012-12 (0805)size					

*Spec. values are specified for each parts number.

■ Capacitance Range

● M case : 1608-10(0603)size

Capacitance (μF)	Rated Voltage(V.DC)			
	4	6.3	10	16
10 (106)				M
22 (226)			M	
47 (476)		M		
100 (107)	M			

● PS case : 2012-09(0805)Ultra-Low Profile size

Capacitance (μF)	Rated Voltage(V.DC)			
	4	6.3	10	16
22 (226)				
47 (476)			PS	
100 (107)				
220 (227)				

● P case : 2012-12(0805)size

Capacitance (μF)	Rated Voltage(V.DC)			
	4	6.3	10	20
10 (106)				P
47 (476)			P	
100 (107)		P		
150 (157)		P		
220 (227)	P			

*Usage precaution : Based on JEITA Technical Report "EIAJ RCR-2368A"

Bottom Surface Electrode(Large Capacitance) : TCT, TC series

- U case : 1005-055(0402)size
- ML case : 1608-06(0603)Low Profile size
- M case : 1608-09(0603)size

■ Dimensions

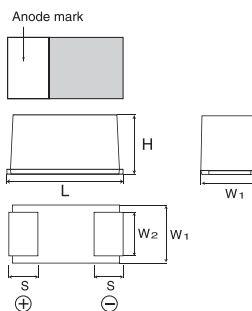
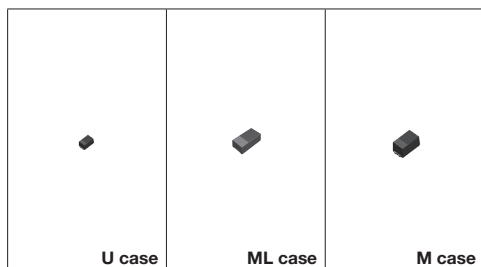

(Unit : mm)

Dimensions	Size		
	U case	ML case	M case
L	1.0+0.2/-0	1.6±0.1	1.6±0.1
W ¹	0.5+0.2/-0	0.85±0.1	0.85±0.1
W ²	0.35±0.1	0.55±0.1	0.55±0.1
H	Max. 0.55	0.55±0.1	0.8±0.1
S	0.35±0.1	0.5±0.1	0.5±0.1

Series Name	Case Name	Capacitance Tolerance	Operating Temperature	Tangent of Loss Angle	Leakage Current	ESR
TCT series	U case 1005-055 (0402)size	±10%(K) ±20%(M)	-55°C to +125°C Rated Voltage at -55°C to +85°C DeRated Voltage at +85°C to +125°C	Max. 50% at 120Hz(25°C)*	0.5µA or 0.1 CV whichever is greater (25°C, 5 min.)*	Max. 35.0Ω(at 100kHz)*
	ML case 1608-06 (0603)Low Profile size	±20%(M)		Max. 30% at 120Hz(25°C)*		Max. 15.0Ω(at 100kHz)*
TC series	M case 1608-09 (0603)size				0.5µA or 0.01 CV whichever is greater (25°C, 5 min.)*	

*Spec. values are specified for each parts number.

■ Capacitance Range

● U case : 1005-055(0402)size

Capacitance (µF)	Rated Voltage(V.DC)					
	2.5	4	6.3	10	16	20
0.33 (334)						U
0.47 (474)			U			
1 (105)			U	☆U	☆U	
2.2 (225)			U			
4.7 (475)		U	U			
10 (106)		☆U				
15 (156)	U					

☆:Under Development

● ML case 1608-06(0603)Low Profile size

Capacitance (µF)	Rated Voltage(V.DC)					
	4	6.3	10	16	20	25
1 (105)						ML
2.2 (225)						
4.7 (475)						
10 (106)						
22 (226)						

● M case : 1608-09(0603)size

Capacitance (µF)	Rated Voltage(V.DC)					
	4	6.3	10	16	20	25
1 (105)				M		M
2.2 (225)			M	M		
4.7 (475)		M	M			
10 (106)	M	M	M			
22 (226)	M	M				
33 (336)	☆M	M				

☆:Under Development

*Usage precaution : Based on JEITA Technical Report "EIAJ RCR-2368A"

Bottom Surface Electrode(Large Capacitance) : TCT series

- PL case : 2012-10(0805)Low Profile size
- P case : 2012-12(0805)size
- AS case : 3216-10(1206)Ultra-Low Profile size
- AL case : 3216-12(1206)Low Profile size

Dimensions

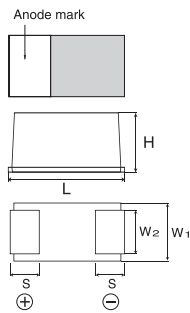

(Unit : mm)

Dimensions	Size			
	PL case	P case	AS case	AL case
L	2.0±0.2	2.0±0.2	3.2±0.2	3.2±0.2
W ¹	1.25±0.2	1.25±0.2	1.6±0.2	1.6±0.2
W ²	0.85±0.2	0.85±0.2	1.2±0.2	1.2±0.2
H	0.9±0.1	Max. 1.2	0.9±0.1	1.1±0.1
S	0.5±0.2	0.5±0.2	0.8±0.2	0.8±0.2

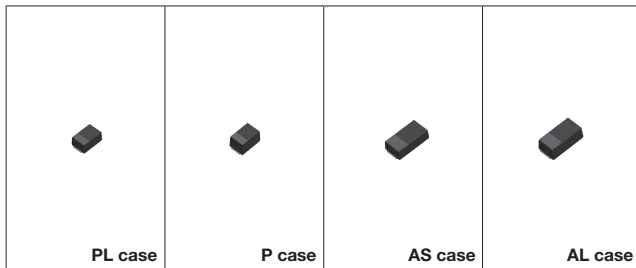

Series Name	Case Name	Capacitance Tolerance	Operating Temperature	Tangent of Loss Angle	Leakage Current	ESR
TCT series	PL case 2012-10 (0805)Low Profile size	±20%(M)	-55°C to +125°C Rated Voltage at -55°C to +85°C DeRated Voltage at +85°C to +125°C	Max. 30% at 120Hz(25°C)*	Max. 0.05 CV (25°C, 5 min.)*	Max. 8.0Ω (at 100kHz)*
	P case 2012-12 (0805)size					
	AS case 3216-10 (1206)Ultra-Low Profile size					
	AL case 3216-12 (1206)Low Profile size					

*Spec. values are specified for each parts number.

Capacitance Range

● PL case : 2012-10(0805)Low Profile size

● P case : 2012-12(0805)size

Capacitance (μF)	Rated Voltage(V.DC)				
	4	6.3	10	16	20
1 (105)					
2.2 (225)					
4.7 (475)					☆PL
10 (106)				PL	
22 (226)			PL		
33 (336)			☆PL		
47 (476)		PL			
100 (107)	PL				

☆:Under Development

Capacitance (μF)	Rated Voltage(V.DC)					
	4	6.3	10	16	20	25
2.2 (225)						P
4.7 (475)						
10 (106)				P		
22 (226)			P			
33 (336)			P			
47 (476)	P	P	☆P			
100 (107)	P					

☆:Under Development

● AS case : 3216-10(1206)Ultra-Low Profile size

● AL case : 3216-12(1206)Low Profile size

Capacitance (μF)	Rated Voltage(V.DC)						
	4	6.3	10	16	20	25	35
1 (105)							AS
2.2 (225)							☆AS
4.7 (475)						☆AS	
10 (106)					☆AS		
22 (226)				☆AS			
33 (336)			☆AS				
47 (476)		AS	AS				
100 (107)		AS					
220 (227)	AS						

☆:Under Development

Capacitance (μF)	Rated Voltage(V.DC)							
	2.5	4	6.3	10	16	20	25	35
3.3 (335)								AL
4.7 (475)							AL	
10 (106)						AL		
22 (226)					AL	AL		
33 (336)					AL			
47 (476)				AL				
100 (107)			AL	☆AL				
150 (157)			AL					
220 (227)		AL	☆AL					
330 (337)	☆AL							

☆:Under Development

*Usage precaution : Based on JEITA Technical Report "EIAJ RCR-2368A"

Standard : TC series

■ P case : 2012-12(0805)size

■ A case : 3216-18(1206)size

■ Dimensions

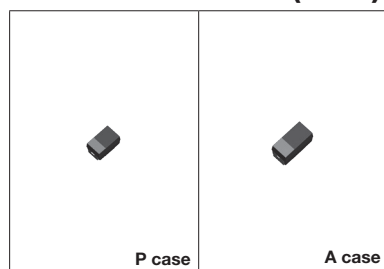

Anode mark

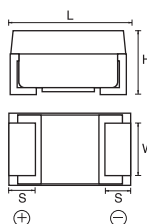
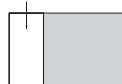

(Unit : mm)

Dimensions	Size	
	P case	A case
L	2.0±0.2	3.2±0.2
W ¹	1.25±0.2	1.6±0.2
W ²	0.9±0.2	1.2±0.2
H	Max. 1.2	1.6±0.2
S	0.45±0.3	0.8±0.3

Series Name	Case Name	Capacitance Tolerance	Operating Temperature	Tangent of Loss Angle	Leakage Current	ESR
TC series	P case 2012-12 (0805)size	±20%(M)	-55°C to +125°C Rated Voltage at -55°C to +85°C DeRated Voltage at +85°C to +125°C	Max. 25% at 120Hz(25°C)*	0.5μA or 0.01 CV whichever is greater (25°C, 1 min.)*	Max. 17.5Ω(at 100kHz)*
	A case 3216-18 (1206)size			Max. 30% at 120Hz(25°C)*		Max. 8.8Ω(at 100kHz)*

*Spec. values are specified for each parts number.

■ Capacitance Range

● P case : 2012-12(0805)size

Capacitance (μF)	Rated Voltage(V.DC)					
	4	6.3	10	16	20	25
1 (105)			P	P		P
2.2 (225)		P	P			
4.7 (475)		P	P			
10 (106)	P		P			
22 (226)	P	P				

● A case : 3216-18(1206)size

Capacitance (μF)	Rated Voltage(V.DC)					
	4	6.3	10	16	20	25
1 (105)					A	A
4.7 (475)				A	A	A
10 (106)			A	A		
22 (226)			A			
47 (476)		A				
100 (107)	A					

● Part Number Explanation

■ Conductive Polymer Capacitors

T	C	S	O	M	0	J	4	7	6	M	8	R	—	Z	M	1			
Series Name				Case		Rated Voltage		Capacitance		Capacitance Tolerance		Packaging		Product Specification		ESR		Discrimination Code	
TCSO(New Bottom Surface Electrode) TCTO(Bottom Surface Electrode) TCO(Standard)				Code Size mm[inch] U2 1005-064[0402] M 1608-09[0603] PS 2012-09[0805] Ultra-Low Profile PL 2012-10[0805] Low Profile P 2012-12[0805] AS 3216-10[1206] Ultra-Low Profile AL 3216-12[1206] Low Profile A 3216-18[1206] BL 3528-12[1411] Low Profile B 3528-21[1411]		Code Rated Voltage (V) 0E 2.5 0G 4 0J 6.3 1A 10 1C 16 1D 20 1E 25 1V 35		Nominal capacitance (in pF) is denoted by 3 digits : 2 significant figures followed by a 3rd digit representing the number of zeroes (i.e. 226 = 22,000,000pF)		Code Capacitance Tolerance M ±20%		Code Tape Width Parts Orientation 8R 8mm Positive electrode on the side opposite to sprocket hole		Code Specifications Z ESR sorting product E Halogen-free materials product (TCOB series)		Code ESR Max.(mΩ) E 15 K 25 N 35 S 45 U 55 W 70 B 100 F 150 D 200 M 300 T 500		Code Specifications 1 Usually Other than 1 Special specifications	

■ Tantalum Capacitors

T	C		A	0	J	1	0	6	M	8	R	—	△
Series Name			Case		Rated Voltage		Capacitance		Capacitance Tolerance		Packaging		Discrimination Code
TCS (New Bottom Surface Electrode) TCT (Bottom Surface Electrode) TC(Standard)			Code Size mm[inch] U 1005-055[0402] ML 1608-06[0603] Low Profile M 1608-09[0603] M 1608-10[0603] PS 2012-09[0805] Ultra-Low Profile PL 2012-10[0805] Low Profile P 2012-12[0805] AS 3216-10[1206] Ultra-Low Profile AL 3216-12[1206] Low Profile A 3216-18[1206]		Code Rated Voltage(V) 0E 2.5 0G 4 0J 6.3 1A 10 1C 16 1D 20 1E 25 1V 35		Nominal capacitance(pF) is denoted by 3 digits : 2 significant figures followed by a 3rd digit representing the number of zeroes that follow		Code Capacitance Tolerance K ±10% M ±20%		Code Tape Width Parts Orientation 8R 8mm Positive electrode on the side opposite to sprocket hole		△

● Package Quantity

■ Conductive Polymer Capacitors

Case(mm[inch])	Series	Package Quantity(pcs)
U2(1005-064[0402])	TCTO	10,000
M(1608-09[0603])		4,000
PS(Ultra-Low Profile 2012-10[0805])	TCSO	3,000
PL(Low Profile 2012-10[0805])		
P(2012-12[0805])		
AS(Ultra-Low Profile 3216-10[1206])	TCTO	2,000
AL(Low Profile 3216-12[1206])		
A(3216-18[1206])		
BL(Low Profile 3528-12[1411])		
B(3528-21[1411])	TCO	2,000

■ Tantalum Capacitors

Case(mm[inch])	Series	Package Quantity(pcs)
U(1005-055[0402])	TCT	10,000
ML(1608-06[0603] Low Profile)		5,000
M(1608-09[0603])	TC	4,000
M(1608-10[0603])	TCS	3,000
PS(2012-09[0805] Ultra-Low Profile)		
PL(Low Profile 2012-10[0805])		
P(2012-12[0805])	TCS/TCT/TC	3,000
AS(Ultra-Low Profile 3216-10[1206])	TCT	
AL(Low Profile 3216-12[1206])		TC
A(3216-18[1206])	2,000	



Opto Devices

LEDs

CONTENTS

■ SMD LEDs	P. E2
Quick Reference of Brightness	P. E2
Characteristics	P. E5
Part No. Configuration	P. E9
Dimensions	P. E10
■ Through-hole LEDs	P. E12
Quick Reference of Brightness	P. E12
Characteristics	P. E14
Part No. Configuration	P. E15
Viewing Angle	P. E16
Dimensions	P. E16

ISO/TS 16949-approved



SMD LEDs

ROHM's chip LEDs are designed for automatic surface mount processes and are available in a wide variety of package sizes (from 1.0×0.6mm)

Red(V,U) Quick Reference of Brightness

Package Structure	Package Size (mm)	Height (mm)	Luminous Intensity (cd)	I _f (mA)	1.0 to 1.6	1.6 to 2.5	2.5 to 4.0	4.0 to 6.3	6.3 to 10	10 to 16	16 to 25	25 to 40	40 to 63	63 to 100	100 to 160	160 to 250	250 to 400	400 to 630	630 to 1000	1000 to 1600	1600 to 2500	2500 to 3120																
Mini-mold	1006	0.2	1	SML-P11VT(R)					SML-P11UT(R)																													
				5											☆SML-P15UT(A)*																							
										SML-P12VT(R)					SML-P12UT(R)																							
		20						SML-P12U2T(R)					SML-E12V8W					SML-E12U8W																				
													SML-E12UW					SML-D15VW					SML-D14VW(A)															
	1608	0.36	20						SML-D13VW(A)*					SML-D12V1W					SML-D12V8W																			
																			SML-D15UW																			
																			SML-D14U2W(A)*					SML-D13UW(A)*														
																			SML-D13U8W					SML-D12U1W					SML-D12U8W									
	20125	0.8	20						SML-H12V8T					SML-H12U8T					SML-M13VT					SML-M13UT														
																								SML-Z14V4T*					SML-Z14U4T*									
	PLCC2	3528	1.9	50																SML-Z14VT(A)*					SML-Z14UT(A)*													
	Side View (mold)	16115	0.55	20						SML-A12V8T					SML-A12U8T					*SML-A12UT(J)																		
Reverse Mount	34125	1.1	10						SML-811VT(A)*					SML-811UT(A)*																								
Lens	1608	1.24	20											☆CSL1001VT					☆CSL0901VT					☆CSL0901UT					☆CSL0902VT									
																													☆CSL0902UT					SML-S13VT				
Lens	3216	1.85	20																															SML-S13UT				
Package Structure	Package Size (mm)	Height (mm)	Luminous Intensity (cd)	I _f (mA)	6 to 7	7 to 8	8 to 9	9 to 10	10 to 12	12 to 14	14 to 16	16 to 18	18 to 20	20 to 22	22 to 25	CSL0701UT																						

Orange(D) Quick Reference of Brightness

Package Structure	Package Size (mm)	Height (mm)	Luminous Intensity (cd)	I _f (mA)	1.0 to 1.6	1.6 to 2.5	2.5 to 4.0	4.0 to 6.3	6.3 to 10	10 to 16	16 to 25	25 to 40	40 to 63	63 to 100	100 to 160	160 to 250	250 to 400	400~630	630 to 1000	1000 to 1600	1600 to 2800																			
Mini-mold	1006	0.2	1	SML-P11DT(R)										☆SML-P15DT(A)*																										
				5											SML-P12DT(R)																									
																				*SML-E12DW																				
		20											SML-E12D8W					SML-D15DW																						
																		SML-D14DW(A)*					SML-D13DW(A)*					SML-D12D8W												
	1608	0.36	20																SML-D12D1W					SML-H12D8T					SML-M13DT											
																													SML-Z14D4T*											
																													SML-Z14DT(A)*											
	20125	0.8	20																																					
	PLCC2	3528	1.9	50																																				
	Side View (mold)	16115	0.55	20											SML-A12D8T					SML-A12DT(J)																				
Reverse Mount	34125	1.1	10						SML-811DT(A)*																															
Lens	1608	1.24	20																					☆CSL0901DT					☆CSL0902DT											
																																		SML-S13DT						
Lens	3216	1.85	20																															CSL0701DT						
Package Structure	Package Size (mm)	Height (mm)	Luminous Intensity (cd)	I _f (mA)	6 to 7	7 to 8	8 to 9	9 to 10	10 to 12	12 to 14	14 to 16	16 to 18	18 to 20	20 to 22	22 to 24	24 to 27	27 to 30	30 to 33	33 to 36	36 to 40	40 to 45	45 to 56	CSL0701DT																	

*:Please note that the brightness of some products may fall between ranks (half rank).

※:Brightness on specification sheet include tolerance of within ±10%. Note: Please be sure to refer the specifications about the rank.

☆:Under Development

Yellow(Y,W) Quick Reference of Brightness

Package Structure	Package Size (mm)	Height (mm)	Luminous Intensity (mcd)	1.0 to 1.6	1.6 to 2.5	2.5 to 4.0	4.0 to 6.3	6.3 to 10	10 to 16	16 to 25	25 to 40	40 to 63	63 to 100	100 to 160	160 to 250	250 to 400	400 to 630	630 to 1000	1000 to 1600	1600 to 2500			
Mini-mold	1006	0.2	1					SML-P11YT(R)							SML-P12YT(R)								
			20													SML-P12Y2T(R)	SML-P12Y3T(R)						
	1608	0.36	20													SML-P12WT(R)	SML-E12Y8W						
			2			SML-D11YW																	
		0.55	20			SML-D12W8W(A)*																SML-D15YW	
																						SML-D14YW(A)*	SML-D14WW(A)*
	20125	0.8	20														SML-D13WW(A)*	SML-D13Y8W					
																		SML-D13Y2W	SML-D12Y3W	SML-D12Y1W			
	Reflector	20125	0.8	20												SML-D12Y8W	SML-H12Y8T						
	PLCC2	3528	1.9	50												SML-M13YT							
20																					SML-Z14Y4T*		
Side View (mold)	16115	0.55	20												SML-A12Y8T	*SML-A12WT(J)							
Reverse Mount	34125	1.1	10																	SML-A15YT			
Lens	1608	1.24	20																				
	3216	1.85	20																				

Yellow Green(M), Green(P,F) Quick Reference of Brightness

Package Structure	Package Size (mm)	Height (mm)	Luminous Intensity (mcd)	0.63 to 1.0	1.0 to 1.6	1.6 to 2.5	2.5 to 4.0	4.0 to 6.3	6.3 to 10	10 to 16	16 to 25	25 to 40	40 to 63	63 to 100	100 to 160	160 to 250	250 to 400	400 to 630	630 to 1000	1000 to 1800	1800 to 2500		
Mini-mold	1006	0.2	1					SML-P11MT(R)															
			20																				
	1608	0.36	20																				
		0.55	20																				
	20125	0.8	20																				
	Reflector	20125	0.8	20																			
	PLCC2	3528	1.9	50																			
20																							
Side View (mold)	16115	0.55	20																				
Reverse Mount	34125	1.1	20																				
Lens	1608	1.24	20																				
	3216	1.85	20																				

Green(E)/Blue Green(E2,E3) Quick Reference of Brightness

Package Structure	Package Size (mm)	Height (mm)	Luminous Intensity (mcd)	9.0 to 14	14 to 22	22 to 36	36 to 56	56 to 90	90 to 140	140 to 220	220 to 360	360 to 560	560 to 900	900 to 1400	1400 to 2200	2200 to 3600	3600 to 5600	
Mini-mold	1006	0.2	5															
			5															
	1608	0.55	5															
			5															
Reflector	20125	0.8	5															
PLCC2	3528	1.9	20															
Side View (mold)	16115	0.55	5															
Lens	1608	1.24	20															

*:Please note that the brightness of some products may fall between ranks (half rank).

**:Brightness on specification sheet include tolerance of within ±10%. Note: Please be sure to refer the specifications about the rank.

☆:Under Development

SMD LEDs

Blue(B) Quick Reference of Brightness

Package Structure	Package Size (mm)	Height (mm)	Luminous Intensity (mcd)	Luminous Intensity (mcd)															
				0.9 to 1.4	1.4 to 2.2	2.2 to 3.6	3.6 to 5.6	5.6 to 9.0	9 to 14	14 to 22	22 to 36	36 to 56	56 to 90	90 to 140	140 to 220	220 to 360	360 to 560	560 to 900	900 to 1400
Mini-mold	1006	0.2	5	SMLP13BC8T															
	1608	0.36	20	SMLN3BC8T															
		0.55	5	☆SMLD12BN1W															
Reflector	20125	0.8	5	☆CSL1001BT															
		1.06	20	SMLMN2BCT(C)															
PLCC2	3528	1.9	20	SMLZ14BGT(A)*															
Side View(mold)	16115	0.55	5	SMLA13BC8T															
		1.1	20	SMLZ14BGT(A)*															
Reverse Mount	34125	1.1	20	SML812BCT															
		1.85	20	SMLS14BET															
Lens	1608	1.24	5	☆CSL0901BT															
		20	☆CSL0902BT																

White(WB) Quick Reference of Brightness

Package Structure	Package Size (mm)	Height (mm)	Luminous Intensity (mcd)	Luminous Intensity (mcd)															
				9 to 14	14 to 22	22 to 36	36 to 56	56 to 90	90 to 140	140 to 220	220 to 360	360 to 560	560 to 900	900 to 1100	1100 to 1400	1400 to 1800	1800 to 2200	2200 to 2800	2800 to 3600
Mini-mold	1006	0.2	5	SMLP13WBC9W															
	1608	0.36	5	SCMP13WBC8W															
		0.55	5	SMLN3WBC8W															
Side View (Reflector)	16115	0.55	5	☆SMLD12WBN1W															
		0.8	20	SMLA12WBC7W															
Reverse Mount	34125	1.1	5	SML813WBC8W															
Reflector	20125	0.8	5	SMLMN2WB1CW(C)															
		1.9	20	SMLZ14WBGUW(A)*															

Package Structure	Package Size (mm)	Height (mm)	Luminous Intensity (mcd)	Luminous Intensity (mcd)															
				2.2 to 2.8	2.8 to 3.3	3.3 to 4.0	4.0 to 4.8	4.8 to 5.8	5.8 to 7.0	7.0 to 8.5	8.5 to 10.2	10.2 to 12.3	12.3 to 14.8	14.8 to 19	19 to 21.8	21.8 to 24.5	24.5 to 27.2	27.2 to 29.3	29.3 to 32.6
Reflector	4520	0.6	90	SMLK18WBJCW															
				SMLK18WBJDW															
				SMLK28WBJCW															

2 Colors Quick Reference of Brightness

Package Structure	Package Size (mm)	Height (mm)	If (mA)	Luminous Intensity (mcd)	Emitting Color	Luminous Intensity (mcd)							
						4.0 to 6.3	6.3 to 10	10 to 16	16 to 25	25 to 40	40 to 63	63 to 100	100 to 160
Mini-mold	1010	0.2	20	5	Red	SML-P24MUW(R)							
					Yellow Green								
					Blue	SML522BU1W							
		Red	SML-522MUW										
		Yellow Green	SML-522MU8W										
		Orange	SML-522MD8W										
	1315	0.6	20	5	Yellow Green	SML-522MY8W							
					Yellow								
					Yellow Green	☆SML-D22MUW							
		Red	☆SML-D22YVW										
		Yellow											
		Red											
Reverse Mount	34125	1.1	20	20	Yellow Green	SML-822MV8W							
					Red								
					Yellow Green	SML-825MVW							
					Red								

3 Colors Quick Reference of Brightness





Package Structure	Package Size (mm)	Height (mm)	If (mA)	Luminous Intensity (mcd)	Emitting Color	Luminous Intensity (mcd)										
						5.6 to 9.0	9.0 to 14	14 to 22	22 to 36	36 to 56	56 to 90	90 to 140	140 to 220	220 to 360	360 to 560	560 to 900
Mini-mold	1010	0.2	5	5	Red	SMLP34RGB2W										
					Green											
					Blue	SMLP36RGB2W(R)										
					Red											
Reflector	1816	0.5	20	20	Red	MSL0402RGBU										
					Green											
					Blue	SMLVN6RGB1W										
					Red	SMLVN6RGB1U										
		Green		SMLVN6RGB7W												
		Blue		MSL0501RGBW												
		Red		☆MSL0502RGBW												
		Green		MSL0104RGBW												
	2910	1.35	20	20	20	Red	MSL0104RGBU									
						Green										
						Blue	MSL0601RGBU									
						Red										

*:Please note that the brightness of some products may fall between ranks (half rank).

** :Brightness on specification sheet include tolerance of within ±10%. Note: Please be sure to refer the specifications about the rank.

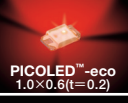
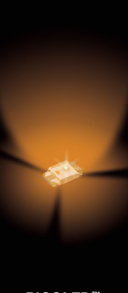
☆:Under Development

SMD LEDs

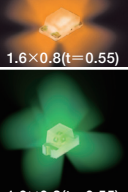
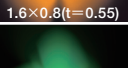
(PICOLED™)																
Package (mm)	Part No.	Emitting Color	Absolute Maximum Ratings(Ta=25°C)						Electrical and Optical Characteristics(Ta=25°C)							Automotive Grade AEC-Q101
			Power Dissipation P _o (mW)	Forward Current I _f (mA)	Peak Forward Current I _{fp} (mA)	Reverse Voltage V _r (V)	Operating Temperature Topr (°C)	Storage Temperature Tstg (°C)	Forward Voltage V _f (V)	I _f (mA)	Max. Reverse Current I _r (μA)	V _r (V)	Dominant Wavelength λ _d / Chromaticity Coordinates(x,y)	Luminous Intensity I _v (mcd)	I _f (mA)	
	SML-P11VT(R)	Red	50									626	2	4	—	
	SML-P11UT(R)	Red										621	1	3		
	SML-P11DT(R)	Orange	52	20	100 ^{*2}	5	-40 to +85	-40 to +100	1.8	1	10	5	605	4		7
	SML-P11YT(R)	Yellow							1.9				586	4		8
	SML-P11MT(R)	Yellow Green	54										569	1		2
	SML-P12VT(R)	Red	50									630	25	60	—	
	SML-P12UT(R)	Red										620	40	85		
	SML-P12U2T(R)	Orange										615	25	70		
	SML-P12DT(R)	Orange										605	63	100		
	SML-P12Y3T(R)	Yellow	52	20	100 ^{*2}				2.1	20	10		596	40		90
	SML-P12YT(R)	Yellow											590	100		20
	SML-P12WT(R)	Yellow											585	25		70
	SML-P12Y2T(R)	Yellow											580	16		50
	SML-P12M2T(R)	Yellow Green	54			5	-40 to +85	-40 to +100	2.2			5	576	10		25
	SML-P12MT(R)	Yellow Green											572	6		18
	SML-P13FT(R)	Green	52						2.1				566	4		10
	SMLP13EC8T	Green	34						3.0				527	(56)		110
	SMLP13BC8T	Blue	34						3.0	5	100		470	(9)		25
	SCMP13WBC8W	White	33	10	50 ^{*2}				2.9	5	100	(x,y)(0.30,0.30)	90	150		5
	SMLP13WBC9W	White										(x,y)(0.29,0.28)	56	150		5
	☆SML-P15UT(A)	Red	36	15	100 ^{*2}	5	-40 to +85	-40 to +100	1.9	5	10	5	620	45		(80)
☆SML-P15DT(A)	Orange							2.0				56	(105)			
(Mold type(1608))																
	SML-E12UW	Red	62	25	60 ^{*1}		-30 to +85	-40 to +85	2.0				624	36	85	—
	SML-E12DW	Orange											607	56	150	
	SML-E12V8W	Red											630	16	40	
	SML-E12U8W	Red											620	25	63	
	SML-E12D8W	Orange	54						2.2	10	5		605	40	100	
	SML-E12Y8W	Yellow		20	100 ^{*2}	5	-40 to +85	-40 to +100					590	25	63	
	SML-E12M8W	Yellow Green											572	10	25	
	SML-E12P8W	Green	68						3.0				560	3	6	
	SML-E12E8T	Blue	66						2.9	5			527	56	120	
	SML-E12E3T	Blue	66						2.9	5			470	5	14	
	SML-E12E3W	White	33	10	50 ^{*2}							(x,y)(0.30,0.30)	56	120	5	
	SML-D11YW	Yellow	67	25	100 ^{*2}	5	-40 to +85	-40 to +100	1.9	2	10	5	588	2	2	
	SML-D12W8W(A)	Yellow	52	20		12	-40 to +100		2.0			12	5	7	2	
	SML-D12V1W	Red											630	25	40	
	SML-D12U1W	Red											620	40	63	
	SML-D12D1W	Orange	54	20	100 ^{*2}	5	-40 to +85	-40 to +100	2.2	20	10	5	605	63	100	
	SML-D12Y1W	Yellow											590	63	100	
	SML-D12M1W	Yellow Green											572	16	30	
	SML-D12V8W	Red											630	16	40	
	SML-D12U8W	Red											620	25	63	
	SML-D12D8W	Orange											605	40	100	
SML-D12Y8W	Yellow	54	20			-40 to +85		2.2	20		5	590	25	63		
SML-D12Y3W	Yellow											581	16	40		
SML-D12M8W	Yellow Green											572	10	25		
SML-D12P8W	Green	67	25	100 ^{*2}	5		-40 to +100					560	3	6		
SML-D12FW	Green	70						3.0			12	565	14	18		
☆SMLD12E1N1W	Blue Green	66	20			-40 to +100						527	56	140		
☆SMLD12E2N1W	Blue Green					-40 to +85						505	(56)	120		
☆SMLD12E3N1W	Blue	66	20			-40 to +100		2.9	5		5	496	56	85		
☆SMLD12BN1W	Blue					-40 to +100						470	(14)	40		
☆SMLD12WBN1W	White											(x,y)(0.295,0.280)	56	120		
	SML-D13VW(A)	Red	72						2.0				630	36	55	YES
	SML-D13UW(A)	Red											620	56	85	
	SML-D13DW(A)	Orange											605	71	120	
	SML-D13WV(A)	Yellow											587	110	110	
	SML-D13MW(A)	Yellow Green	75						2.1	20	10	5	571	28	45	
	SML-D13U8W	Red	52	20			-40 to +100	-40 to +100					620	40	70	
	SML-D13Y8W	Yellow	54						2.2				590	63	100	
	SML-D13Y2W	Yellow	78	30					2.1				581	40	80	
	SML-D13M8W	Yellow Green	52	20					2.2				572	16	30	
	SML-D13FW	Green	81	30					2.1				565	18	22	
	SML-D14VW(A)	Red	72						2.0				630	71	100	
	SML-D14U2W(A)	Red											615	90	160	
	SML-D14DW(A)	Orange											605			
	SML-D14YW(A)	Yellow	75	30	100 ^{*2}	5	-40 to +100	-40 to +100		20	10	5	590	112	200	
	SML-D14VW(A)	Yellow							2.1				587	180		
SML-D14MW(A)	Yellow Green											571	36	60		
	SML-D15VW	Red	84						2.0				630	71	90	YES
	SML-D15UW	Red											620	90	112	
	SML-D15U2W	Red											615	112	140	
	SML-D15DW	Orange		35	100 ^{*2}	5	-40 to +100	-40 to +100		20	(10)	5	605	180	224	
	SML-D15YW	Yellow	87						2.1				590			
SML-D15MW	Yellow Green											571	56	71		
	☆SML-D22MUW	Yellow Green	67						2.0				570	6	10	—
	☆SML-D22YVW	Red	65	25	100 ^{*2}	5	-40 to +105	-40 to +110	1.9	5	10	5	620	10	16	
	☆SML-D22YVW	Yellow	67						1.9				588	16	25	
	☆CSL1001VT	Red							(1.8)				630	(71)	(112)	(YES)
	☆CSL1001YT	Yellow	72	30	100	12	-40 to +100		2.0	20		12	590	(112)	(180)	
	☆CSL1001MT	Yellow Green							2.1		10		571	(36)	(56)	
	☆CSL1001ET	Green	74	20	100 ^{*2}								(527)	(56)	(110)	
☆CSL1001BT	Blue	17	5	10 ^{*2}	5	-40 to +85		2.9	5		5	470	(9)	(18)		

*1:Duty1/5, 200Hz *2:Duty1/10, 1kHz *3:Duty≤1/20, 1ms *4:Duty≤1/5, 1kHz *5:Duty1/10, pulse width 10ms Max.

☆:Brightness for white color is noted with chromaticity coordinate (x, y).

Note1: Automotive Grade product : Addition(C)

Note2: "PICOLED™" is a pending trademarks of ROHM Co., Ltd. (YES)··Planning

():Reference ☆ : Under Development

SMD LEDs

(Mold type(1608))																																		
Package (mm)	Part No.	Emitting Color	Absolute Maximum Ratings(Ta=25°C)						Electrical and Optical Characteristics(Ta=25°C)																									
			Power Dissipation P _o (mW)	Forward Current I _F (mA)	Peak Forward Current I _{FP} (mA)	Reverse Voltage V _R (V)	Operating Temperature Topr (°C)	Storage Temperature Tstg (°C)	Forward Voltage V _F		Reverse Current I _R		Dominant Wavelength λ _d		Luminous Intensity I _v				Automotive Grade AEC-Q101															
								Typ. (V)	I _F (mA)	Max. (μA)	V _R (V)	Typ.* (nm)	I _F (mA)	Min. (mcd)	Typ. (mcd)	I _F (mA)																		
	☆CSL0901VT	Red	50	20	100*2	12	-40 to +100	-40 to +100	2.0	20	10	12	630	20	(112)	174	20	(YES)																
	☆CSL0901UT												620						(140)	300														
	☆CSL0901DT	605											(224)						400															
	☆CSL0901YT	590											(180)						320															
	☆CSL0901WT	587																	300															
	☆CSL0901MT	572											(56)						100															
	☆CSL0901PT	560											(18)						30															
	☆CSL0901ET	70											100						5	-40 to +85	3.0	5	5	(527)	5	(220)	(360)	5						
	☆CSL0901BT	34											10																50	5	2.9	5	(470)	(36)
	☆CSL0902VT	Red											84						35	100	12	-40 to +100	-40 to +100	2.1	20	10	12	630	20	(224)	(500)	20	(YES)	
	☆CSL0902UT																											620						(180)
	☆CSL0902DT	605																										(500)						
	☆CSL0902YT	590																										(224)						500
	☆CSL0902WT	587																																(400)
☆CSL0902MT	572	(71)	140																															
☆CSL0902PT	560	(28)	45																															
☆CSL0902ET	95	25	5	-40 to +85	3.4	5	5	(572)	5	(710)	(1,100)	5																						
☆CSL0902BT	34	10												50	5	3.3	5	(527)										(220)						(360)

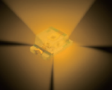
(Mold type(20125))																			
Package (mm)	Part No.	Emitting Color	Absolute Maximum Ratings(Ta=25°C)						Electrical and Optical Characteristics(Ta=25°C)										
			Power Dissipation P _o (mW)	Forward Current I _F (mA)	Peak Forward Current I _{FP} (mA)	Reverse Voltage V _R (V)	Operating Temperature Topr (°C)	Storage Temperature Tstg (°C)	Forward Voltage V _F		Reverse Current I _R		Dominant Wavelength λ _d / Chromaticity Coordinates(x,y)		Luminous Intensity I _v				Automotive Grade AEC-Q101
								Typ. (V)	I _F (mA)	Max. (μA)	V _R (V)	Typ.* (nm)	I _F (mA)	Min. (mcd)	Typ. (mcd)	I _F (mA)			
	SML-H12V8T	Red	54	20	100*2	5	-40 to +85	-40 to +100	2.2	20	10	5	630	20	40	25	20	YES	
	SML-H12U8T												620						25
	SML-H12D8T	605											40						63
	SML-H12Y8T	590											10						25
	SML-H12M8T	572																	
	SML-H12P8T	560											3						4

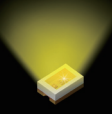
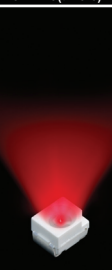
(Reflector type)																																																														
Package (mm)	Part No.	Emitting Color	Absolute Maximum Ratings(Ta=25°C)						Electrical and Optical Characteristics(Ta=25°C)																																																					
			Power Dissipation P _o (mW)	Forward Current I _F (mA)	Peak Forward Current I _{FP} (mA)	Reverse Voltage V _R (V)	Operating Temperature Topr (°C)	Storage Temperature Tstg (°C)	Forward Voltage V _F		Reverse Current I _R		Dominant Wavelength λ _d / Chromaticity Coordinates(x,y)		Luminous Intensity I _v				Automotive Grade AEC-Q101																																											
								Typ. (V)	I _F (mA)	Max. (μA)	V _R (V)	Typ.* (nm)	I _F (mA)	Min. (mcd)	Typ. (mcd)	I _F (mA)																																														
	SML-M13VT	Red	75	30	100*2	5	-40 to +85	-40 to +100	2.0	20	10	5	630	20	40	75	20	-																																												
	SML-M13UT												620						63	120																																										
	SML-M13DT	605											100						160																																											
	SML-M13YT	590											25						45																																											
	SML-M13MT	572																		6	16																																									
	SML-M13PT	560											56						140																																											
	SMLMN2ECT(C)	70											20						12	-40 to +100	3.0	5	12	527	5	56	140	5	YES																																	
	SMLMN2BCT(C)	68											20						12	-40 to +100	2.9	5	12	470	5	14	36	5	YES																																	
	SMLMN2WB1CW(C)																							(x,y)(0.30,0.28)		56	140																																			
		SML-Z14V4T											Red						189	70	200*2	12	-40 to +100	-40 to +100	2.0	50	10	12	630	50	355	710	50	-																												
		SML-Z14U4T																											620						280	560																										
SML-Z14D4T		605	112	224																																																										
SML-Z14Y4T		590			56	120																																																								
SML-Z14M4T		572	22	56																																																										
SML-Z14F4T		565	56	120																																																										
SML-Z14P4T		561	22	56																																																										
SML-Z14VT(A)		Red	168	30	5	-40 to +85	-40 to +100	-40 to +100	1.9	10	10	12	630	20	45	90	20	YES																																												
SML-Z14UT(A)													620																112						224																											
SML-Z14DT(A)		605											140																280																																	
SML-Z14YT(A)		589																																	45	90																										
SML-Z14MT(A)		571											22																45																																	
SML-Z14FT(A)		564											22																45																																	
SML-Z14PT(A)		560											11																22																																	
SMLZ14EGT(A)		120											3.4																5						528	710	1,100																									
SMLZ14BGT(A)		Blue											114																30						5	-40 to +85	-40 to +85	-40 to +85	3.3	5	5	5	470	20	140	280	300	-														
SMLZ14BGT(A)																																											140						280	300												
SMLZ14BGT(A)																																																										(x,y)(0.30,0.28)	1,800	2,400		

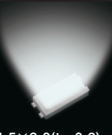
(Reflector(High Power)type)																			
Package (mm)	Part No.	Emitting Color	Absolute Maximum Ratings(Ta=25°C)						Electrical and Optical Characteristics(Ta=25°C)										
			Power Dissipation P _o (mW)	Forward Current I _F (mA)	Peak Forward Current I _{FP} (mA)	Reverse Voltage V _R (V)	Operating Temperature Topr (°C)	Storage Temperature Tstg (°C)	Forward Voltage V _F		Reverse Current I _R		Chromaticity Coordinates		Luminous Intensity I _v				Automotive Grade AEC-Q101
								Typ. (V)	I _F (mA)	Max. (μA)	V _R (V)	(x, y)	I _F (mA)	Min. (mcd)	Typ. (mcd)	I _F (mA)	Luminous Flux φ _v (lm)		
	SMLK18WBJCW	White	675	150	230*5	5	-40 to +100	-40 to +100	3.9	90	10	5	(0.30, 0.28)	90	4,800	6,000	90	22	90
	SMLK18WBJDW												(0.34, 0.34)						
	SMLK28WBJCW												(0.30, 0.28)						

*1:Duty1/5, 200Hz *2:Duty1/10, 1kHz *3:Duty≤1/20, 1ms *4:Duty≤1/5, 1kHz *5:Duty1/10, pulse width 10ms Max.
 *:Brightness for white color is noted with chromaticity coordinate (x, y).
 Note1: Automotive Grade product : Addition(C)
 Note2: *PICOLED™ is a pending trademarks of ROHM Co., Ltd. (YES) : Planning () : Reference ☆ : Under Development



SMD LEDs

Side View type																															
Package (mm)	Part No.	Emitting Color	Absolute Maximum Ratings(Ta=25°C)					Electrical and Optical Characteristics(Ta=25°C)					Automotive Grade AEC-Q101																		
			Power Dissipation P _D (mW)	Forward Current I _F (mA)	Peak Forward Current I _{FP} (mA)	Reverse Voltage V _R (V)	Operating Temperature Topr (°C)	Storage Temperature Tstg (°C)	Forward Voltage V _F Typ. (V)	I _F (mA)	Max. Reverse Current I _R (μA)	V _R (V)			Dominant Wavelength λ _D /Chromaticity Coordinates(x,y) Typ.*(nm)	I _F (mA)	Luminous Intensity I _v Min. (mcd)	Typ. (mcd)													
 1.6×1.15(t=0.55)	SML-A12V8T	Red	54	20	100*2	5	-40 to +85	-40 to +100	2.2	20	10	5	630	20	16	40	—														
	SML-A12U8T												620		25	63															
	SML-A12D8T	Orange											605		40	100															
	SML-A12Y8T	Yellow											590		25	63															
	SML-A12M8T	Yellow Green											572		10	25															
	SML-A12P8T	Green											560		3	6															
	SML-A12UT(J)	Red											75		30	100*2		5	-40 to +100	2.0	20	10	5	624	36	100	—				
	SML-A12DT(J)	Orange											606		36	100															
	SML-A12WT(J)	Yellow											65		30	100*2		5	-40 to +100	2.1	20	10	5	590	22	63					
	SML-A12MT(J)	Yellow Green											75		25	100*2		5	-30 to +85	2.1	20	10	5	570	14	40					
	SML-A15YT	Yellow											87		35	100*2		5	-40 to +100	2.1	20	10	5	590	180	—					
	SMLA12EC6T	Green											68		20	100*2		5	-40 to +85	3.0	5	100	5	527	56	—					
	SMLA13BC8T	Blue											66		20	100*2		5	-40 to +85	2.9	5	10	5	470	22	36	5				
	SMLA12WBC7W	White											33		10	50*2		5	-40 to +85	2.9	5	10	5	(x,y)(0.30,0.30)	56	—					
	 2.8×1.2(t=0.8)	CSL0406WBCW											White		117	30		100*2	5	-40 to +85	-40 to +100	(3.2)	20	50	5	(x,y)(0.30,0.28)	20	1,400	2,200	20	—
Reverse Mount type																															
 Mold type 3.4×1.25(t=1.1)	SML-811VT(A)	Red	62	25	100*2	5	-40 to +85	-40 to +100	2.0	10	100	5	630	10	11	22	10	YES													
	SML-811UT(A)												620																		
	SML-811DT(A)	Orange											605																		
	SML-811WT(A)	Yellow											590						14	28											
	SML-812MT	Yellow Green											65						60*1	4	-30 to +85	-40 to +85	2.1	20	4	4	571	20	40	20	—
	SML812BCT	Blue											80						20	100*2	5	-40 to +85	-40 to +100	3.3	20	5	5	470	22	56	20
SML813WBC8W	White	33	10	50*2	5	-40 to +85	-40 to +100	(2.9)	5	10	5	(x,y)(0.30,0.30)	5	45	5	—															
 Surface mount Circular type 3.4×1.6(t=1.85)	SML-S13VT	Red	75	30	100*2	5	-40 to +85	-40 to +100	1.9	20	10	5	630	20	160	450	—														
	SML-S13UT												620		400	700															
	SML-S13DT	Orange											605		630	1,400															
	SML-S13YT	Yellow											590		160	400															
	SML-S13MT	Yellow Green											78		572	63		160													
	SML-S13PT	Green											560		180	3,000															
SMLS14EET	Green	117	527	1,800	3,000	—																									
SMLS14BET	Blue	3.2	470	560	800																										
 2 colors type 3.4×1.25(t=1.1)	SML-822MV8W	Yellow Green	54	20	100*2	5	-40 to +85	-40 to +100	2.2	20	100	5	572	20	16	25	20	—													
	SML-825MVW	Red	630	16									30																		
	SML-825MVW	Yellow Green	80	30									572		40	63															
 Surface Mount Lens type 3.4×1.25(t=1.1)	SML-825MVW	Red	80	30	572	40	63																								
	SML-825MVW	Red	80	30	630	—	—																								
Surface Mount Lens type																															
Package (mm)	Part No.	Emitting Color	Absolute Maximum Ratings(Ta=25°C)					Electrical and Optical Characteristics(Ta=25°C)					Automotive Grade AEC-Q101																		
			Power Dissipation P _D (mW)	Forward Current I _F (mA)	Peak Forward Current I _{FP} (mA)	Reverse Voltage V _R (V)	Operating Temperature Topr (°C)	Storage Temperature Tstg (°C)	Forward Voltage V _F Typ. (V)	I _F (mA)	Max. Reverse Current I _R (μA)	V _R (V)			Dominant Wavelength λ _D Typ.*(nm)	I _F (mA)	Luminous Intensity I _v Min. (mcd)	Typ. (mcd)													
 1.6×0.8(t=1.24)	☆CSL0901VT	Red	50	20	100*2	12	-40 to +100	-40 to +100	2.0	20	12	5	630	20	(112)	174	—														
	☆CSL0901UT												620		140	300															
	☆CSL0901DT	Orange											605		(224)	400															
	☆CSL0901YT	Yellow											590		(180)	320		20													
	☆CSL0901WT	Yellow											587		(180)	300		—													
	☆CSL0901MT	Yellow Green											572		56	100															
	☆CSL0901PT	Green											560		(18)	30															
	☆CSL0901ET	Green											70		(527)	(220)		(360)	5												
	☆CSL0901BT	Blue											34		10	50		5	-40 to +85	-40 to +100	2.9	5	10	5	(470)	5	(36)	(56)	—		
	☆CSL0902VT	Red											84		35	100*2		12	-40 to +100	-40 to +100	2.0	20	12	5	(630)	20	(140)	(250)	—		
	☆CSL0902UT																								(620)		(180)	(350)			
	☆CSL0902DT	Orange																							(605)		(180)	(350)			
	☆CSL0902YT	Yellow																							(590)		(224)	(500)		20	
	☆CSL0902WT	Yellow																							(587)		(224)	(400)		—	
	☆CSL0902MT	Yellow Green																							(572)		(71)	(140)			
☆CSL0902PT	Green	(560)	(28)	(45)																											
☆CSL0902ET	Green	95	25	5	-40 to +85	-40 to +100	3.4	5	5	5	(527)	(710)		(1,100)			—														
☆CSL0902BT	Blue	3.3	(470)	(220)	(360)	—																									
 Reverse mount available 3.2×1.6(t=1.85)	SML-S13VT	Red	75	30	100*2	5	-40 to +85	-40 to +100	1.9	20	10	5		630			20								160		450	—			
	SML-S13UT													620											400		700				
	SML-S13DT	Orange												605											630		1,400				
	SML-S13YT	Yellow												590											160		400				
	SML-S13MT	Yellow Green												78											572		63			160	
	SML-S13PT	Green												560											180		3,000				
SMLS14EET	Green	117	527	1,800	3,000	—																									
SMLS14BET	Blue	3.2	470	560	800																										
 2.9×2.4(t=3.1)	CSL0701UT	Red	120	50	150*2	5	-40 to +85	-40 to +100	2.1	20	10	5	624	20	9,000	18,000	20	—													
	CSL0701DT	Orange	605	20,000	35,000																										

*1:Duty1/5, 200Hz *2:Duty1/10, 1kHz *3:Duty≤1/20, 1ms *4:Duty≤1/5, 1kHz *5:Duty1/10, pulse width 10ms Max.

*:Brightness for white color is noted with chromaticity coordinate (x, y).

Note: Automotive Grade product : Addition(C) (YES)---Planning

():Reference ☆ : Under Development

SMD LEDs

(2 Colors type)																			
Package (mm)	Part No.	Emitting Color	Absolute Maximum Ratings(Ta=25°C)						Electrical and Optical Characteristics(Ta=25°C)										Automotive Grade AEC-Q101
			Power Dissipation P _D (mW)	Forward Current I _F (mA)	Peak Forward Current I _{FP} (mA)	Reverse Voltage V _R (V)	Operating Temperature Topr (°C)	Storage Temperature Tstg (°C)	Forward Voltage V _F (V)	I _F (mA)	Max. I _R (μA)	V _R (V)	Dominant Wavelength λ _D (nm)		Luminous Intensity I _v (mcd)				
	SML-P24MUW(R)	Yellow Green	54	20	100*2	5	-40 to +85	-40 to +100	2.2	20	10	5	572	20	10	21	20	—	
		Red	52						2.1				620		25	52			
	SML522BU1W	Blue	66			5	-40 to +85	-40 to +100	2.9	5	10	5	470	5	9	22	5	—	
		Red	50		60*2				1.9				624		10	21			
	SML-522MUW	Yellow Green	52				-30 to +85	-40 to +85	2.1				570		14	40		—	
		Red	50						1.9				360		22	63			
	SML-522MU8W	Yellow Green		20						20	100	4	572	20	16	40		—	
		Red				4							620		25	63	20		
SML-522MD8W	Yellow Green	54		100*2		-40 to +85	-40 to +100	2.2				572		10	25		—		
	Orange											605		40	100				
SML-522MY8W	Yellow Green											572		16	40		—		
	Yellow											590		40	63				
	SML-822MV8W	Yellow Green	54	20					2.2				572	20	16	25	—		
		Red			100*2	5	-40 to +85	-40 to +100	2.1	20	100	5	630		30				
	SML-825MVW	Yellow Green	80	30					2.0				572		40	63	—		
		Red							2.0				630						
	☆SML-D22MUW	Yellow Green	67						2.0				570	5	6	10	—		
		Red	65						1.9	5	10	5	620		10	16			
	☆SML-D22YVW	Yellow Green	67	25	100*2	5	-40 to +105	-40 to +110	2.0				588		16	25	5	—	
		Red	65						1.9				629		10	16			
(3 Colors type)																			
	SMLP34RGB2W	Red							2.1				624		14	35	—		
		Green	35	10	50*3	5	-40 to +85	-40 to +100	3.1	5	10	5	527	5	56	110		5	
		Blue							3.0				470		28	45			
	SMLP36RGB2W(R)	Red							2.1				624		14	35	—		
		Green	26	10	50*3	5	-40 to +85	-40 to +100	3.1	5	10	5	527	5	56	110		5	
		Blue							3.0				470		14	35			
	MSL0402RGBU*9	Red	78*9						2.1				624		220	400	—		
		Green	120*9	30	100	5	-40 to +85	-40 to +100	3.5	20	100	5	527	20	360	550		20	
		Blue	114*9						3.3				470		90	180			
	New MSL0501RGBW	Red		50					2.1				624		450	700	—		
		Green	400*9	40					3.3				527		710	1,200			
		Blue							3.3				470		220	400			
	☆MSL0502RGBW	Red							2.1				624		280	500	—		
		Green	180*9	30					3.5				527		560	1,000			
		Blue							3.3				470		140	300			
SMLVN6RGB1W*9	Red		50		5	-40 to +85	-40 to +100	2.1	20	10	5	624	20	450	700	—			
	Green	40	100					3.3				527		710	1,200				
	Blue							3.3				470		220	400				
SMLVN6RGB1U*9	Red	400*9	50		5	-40 to +85	-40 to +100	2.1	10	5		624		450	700	—			
	Green		40					3.3				527		710	1,200				
	Blue							3.3				470		220	400				
New MSLVN6RGB7W	Red		50		5	-40 to +85	-40 to +100	2.1	10	5		624		280	500	—			
	Green	180*9	30					3.5				527		560	1,000				
	Blue							3.3				470		140	300				
	MSL0104RGBW*8	Red		50		5	-40 to +85	-40 to +100	2.1	10	5		624		450	700	—		
		Green		40					3.3				527		710	1,200			
		Blue		40					3.2				470		220	400			
	MSL0104RGBU*9	Red	400*9	50		5	-40 to +85	-40 to +100	2.1	10	5		624		450	700	—		
		Green		40					3.3				527		710	1,200			
		Blue		40					3.2				470		220	400			
	New MSL0601RGBU	Red		40					2.1	10	5		624		600	700	—		
		Green	300*9	30	100	5	-40 to +85	-40 to +100	3.3	20			527	20	1,100	1,250			
		Blue							3.2				470		290	360			

(Surface Mount type Infrared LEDs)

Package (mm)	Part No.	LED Chip	Emitting Color	Absolute Maximum Rating(Ta=25°C)						Electrical and Optical Characteristics(Ta=25°C)									
				Power Dissipation P _D (mW)	Forward Current I _F (mA)	Peak Forward Current I _{FP} (mA)	Reverse Voltage V _R (V)	Operating Temperature Topr (°C)	Storage Temperature Tstg (°C)	Max. V _F (V)	I _F (mA)	Reverse Current I _R (μA)	V _R (V)	Light Wavelength λ _P (nm)		Radiant Intensity			
	☆SML-P15R2T	AlGaAs	Infrared	(40)	(20)	(100)*2	(5)	(-40 to +85)	(-40 to +100)	(1.6)	(100)	(870)		(1.1)					
	☆SML-S15R2T			(100)	(50)	(300)*2				(1.4)	(10)					(840)	(5.6)	(12)	
	SML-M13RT			60		100*2	-40 to +85	-40 to +100	20	5	1.4	10	870	20	0.5	1.7	20		
	SML-S13RT			30	300*2	5												1.5	2.5
	SCM-013RT			57	500*2													0.5	2.0

*1:Duty1/5, 200Hz *2:Duty1/10, 1kHz *3:Duty≤1/20, 1ms *4:Duty≤1/5, 1kHz *5:Duty1/10, pulse width 10ms Max.
 *6:Total power dissipation in case of lighting three colors. (when lighting three colors, it will be reduced down to 30% of it.)
 *7:50mmx50mm, Substrate : FR4 : t=1.6mm Cu foil : t=0.07mm *8:Epoxy resin *9:Silicone resin Note1: Automotive Grade product : Addition(C)

():Reference ☆ : Under Development

Surface Mount Phototransistors																		
Package size(mm)	Part No.	LED Chip	Absolute Maximum Ratings(Ta=25°C)						Electrical and Optical Characteristics(Ta=25°C)									
			Collector-Emitter Voltage (V)	Emitter-Collector Voltage (V)	Collector Current (mA)	Collector Power Dissipation (mW)	Operating Temperature Topr (°C)	Storage Temperature Tstg (°C)	Light Current		Dark Current		Sensitivity Wavelength λp Typ. (nm)	Collector-emitter Saturation Voltage				
								Min. (mA)	Max. (mA)	Vce(V) /ε(Lx)	Max. (μA)	Vce (V)			Min. (V)	Typ. (V)	Max. (V)	Ic(mA) /ε(Lx)
2.0×1.25(t=0.8)	SML-H10TB	Si	32	5	30	80	-30 to +85	-30 to +100	2.0	4.0	5/500	0.5	10	800	—	—	0.4	0.1/500
Reverse mount available 3.4×1.25(t=1.1)	SML-810TB								2.3	3.8								
3.0×1.5(t=2.2)	SCM-014TB								0.3									

Part No. Configuration (Chip LEDs)

Exclude Mono-color(Blue(B), Green(E), White(WB) and RGB)

[SML series/SCM series]

Series name: **S M L** — Package shape: **D 1 2 V** Color: **8** Resin color: **W T 8 6** Terminal shape and taping specifications: **T 8 6** Brightness rank: **8 6**

Chip control symbol: **8** Remarks: **W T 8 6** Special control symbol: **T 8 6**

SML chip LED series	P1 1.0×0.6 t=0.2mm	1 Low current type	V Red	M Yellowish green	T Transparent colorless	T86 Cathode at sprocket hole side(the top)	Refer to specification
SCM chip LED series	E1 1.6×0.8 t=0.36mm	2 High brightness type	U Red	F Green	W Milky white	T86 Cathode at sprocket hole side(the back)	
	D1 1.6×0.8 t=0.55mm	3 Ultra high brightness type	U2 Red	P Green	B Black	T68 Cathode at sprocket hole side(the top)	
	H1 2.0×1.25 t=0.8mm		D Orange	MV Yellowish green/Red			
	M1 2.0×1.25 t=0.8mm		Y3 Yellow	MU Yellowish green/Red			
	01 3.0×2.0 t=1.3mm		Y Yellow	MD Yellowish green/Orange			
	Z1 3.5×2.8 t=1.9mm		W Yellow	MY Yellowish green/Yellow			
	A1 1.6×1.15 t=0.55mm		Y2 Yellow	R Infrared			
	81/82 3.4×1.25 t=1.1mm		M2 Yellowish green	T Phototransistor			
	S1 3.2×1.6 t=1.85mm						
	P2 1.0×1.0 t=0.2mm						
	52 1.3×1.5 t=0.6mm						

[CSL series]

Series name: **C S L 0 7** Package shape: **0 1 D** Color: **0 1 D** Resin color: **T 5** Terminal shape and taping specifications: **T 5** Brightness rank: **5**

Chip control symbol: **0 1 D** Remarks: **T 5** Special control symbol: **T 5**

CSL chip LED series	04 2.8×1.2 t=0.8mm	V Red	W Yellow	T Transparent Colorless	1 Cathode at sprocket hole side(the top)	Refer to specification
	07 2.9×2.4 t=3.1mm	U Red	M Yellowish green	W Milky white	5 Cathode at sprocket hole side(the back)	
	09 1.6×0.8 t=1.24mm	D Orange	P Green			
	10 1.6×0.8 t=1.06mm	Y Yellow	WBx White			

Mono-color(Blue(B), Green(E), White(WB) and RGB)

[SML series/SCM series]

Chromaticity rank(for RGB LED)

*SMLP34RGB2W,

SMLP36RGB2W(R) is not applied.

Series name: **S M L E N 3 W B C 8** Package shape: **W 1** Color: **W B C 8** Resin color: **W 1** Terminal shape and taping specifications: **W 1** Brightness rank: **1**

Chip control symbol: **W B C 8** Remarks: **W 1** Special control symbol: **W 1**

SML chip LED series	P1 1.0×0.6 t=0.2mm	2 High brightness type	E Green	Resin color	T86 Cathode at sprocket hole side(the top)	Refer to specification
SCM chip LED series	E1 1.6×0.8 t=0.36mm	3 Ultra high brightness type	E2 Blue Green	T Transparent Colorless	(in case of white, RGB)	
	D1 1.6×0.8 t=0.55mm		B Blue	W Milky white	1 Cathode at sprocket hole side(the top)	
	MN 2.0×1.25 t=0.8mm		WBx White		3 Cathode at sprocket hole side(the top 2mm pitch)	
	Z1/ZN 3.5×2.8 t=1.9mm		BU Blue/Red	Resin		
	K1/K2 4.5×2.0 t=0.6mm		RGB Red/Green/Blue	(in case of VN6 series)	(in case of S1 and B1 series)	
	A1 1.6×1.15 t=0.55mm			U Silicone	T86 Cathode at sprocket hole side(the back)	
	81 3.4×1.25 t=1.1mm			W Epoxy	T68 Cathode at sprocket hole side(the top)	
	S1 3.2×1.6 t=1.85mm					
	52 1.3×1.5 t=0.6mm					
	P34 1.0×1.0 t=0.2mm					
	P36 1.5×1.0 t=0.2mm					
	VN 3.5×2.8 t=0.6mm					

[MSL series]

Series name: **M S L 0 1 0 4 R G B** Package shape: **U 1** Color: **R G B** Resin color: **U 1** Terminal shape and taping specifications: **U 1** Brightness rank: **1**

Chip control symbol: **0 4 R G B** Remarks: **U 1** Special control symbol: **U 1**

Chromaticity rank(for RGB LED)
*MSL0601RBU is not applied.

MSL Multi color series	01 6.9×2.2 t=2.15mm	RGB Red/Green/Blue	U Silicone	1 Cathode at sprocket hole side(the top)	Refer to specification
	04 1.8×1.6 t=0.5mm		WBx Epoxy		
	05 3.5×2.8 t=0.6mm				
	06 2.9×1.35 t=1.0mm				

SMD LEDs

● Dimensions (Unit:mm)

(Mold type)

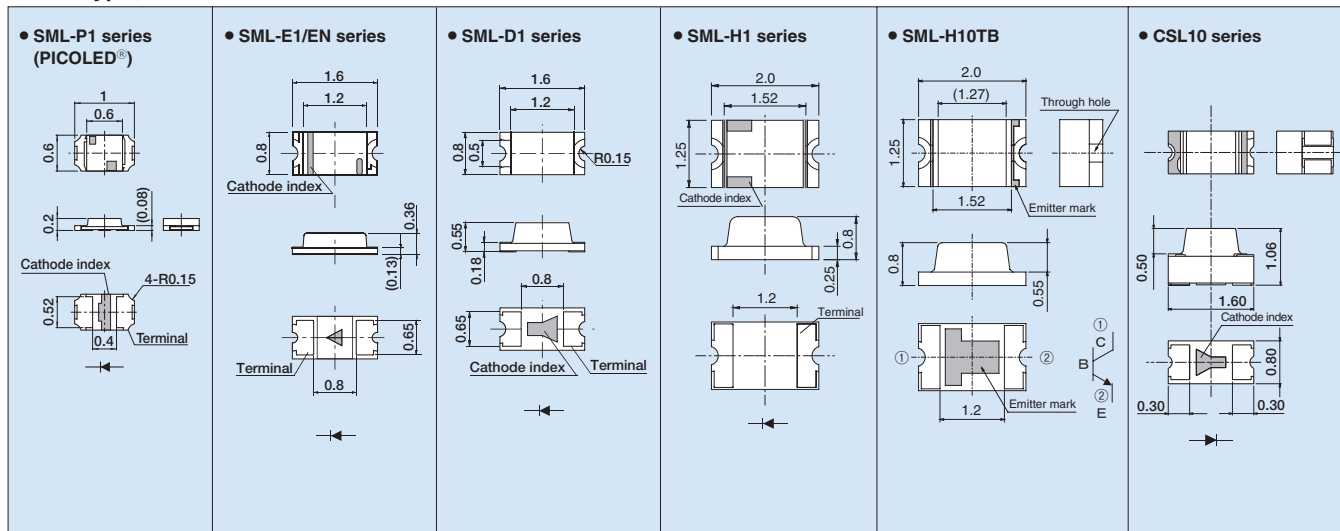

*PICOLED™ is a pending trademarks of ROHM Co., Ltd.

(Reflector type)

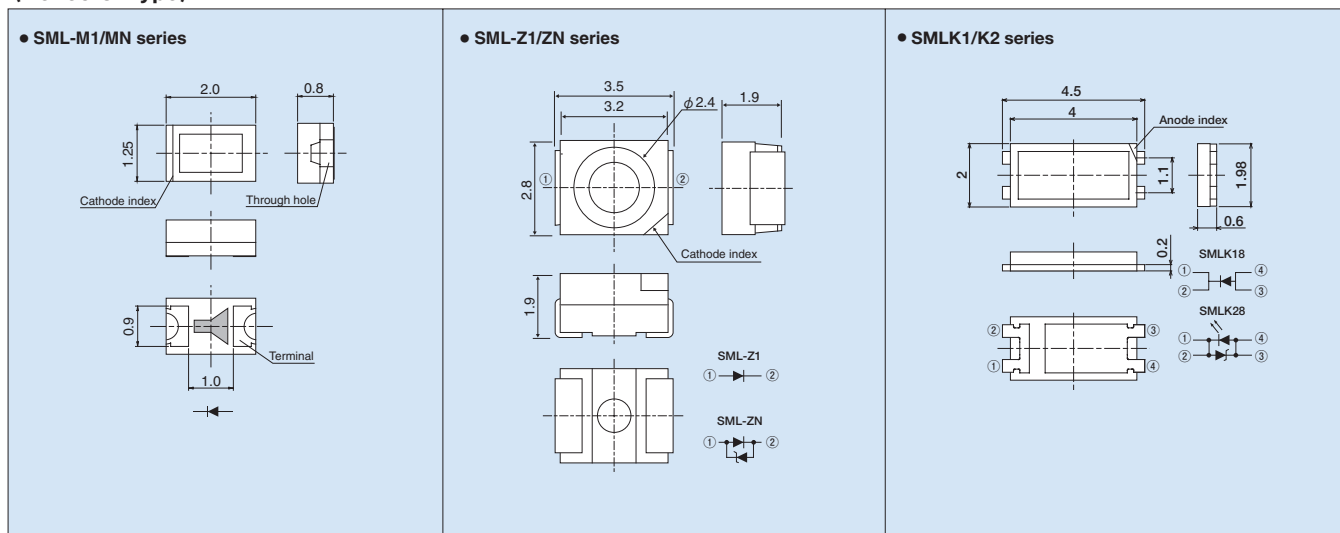

(Side View type)

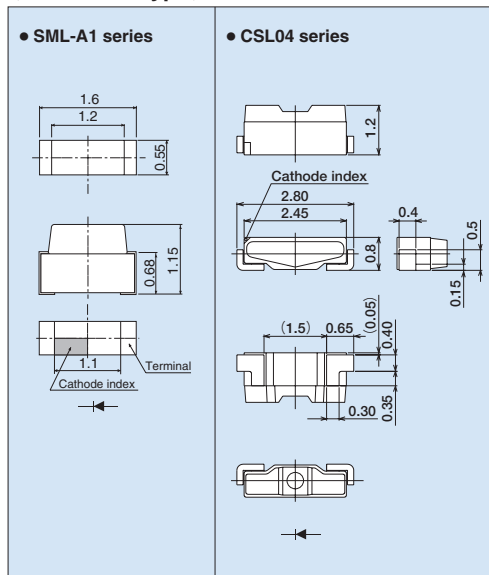

(Reverse Mount type)

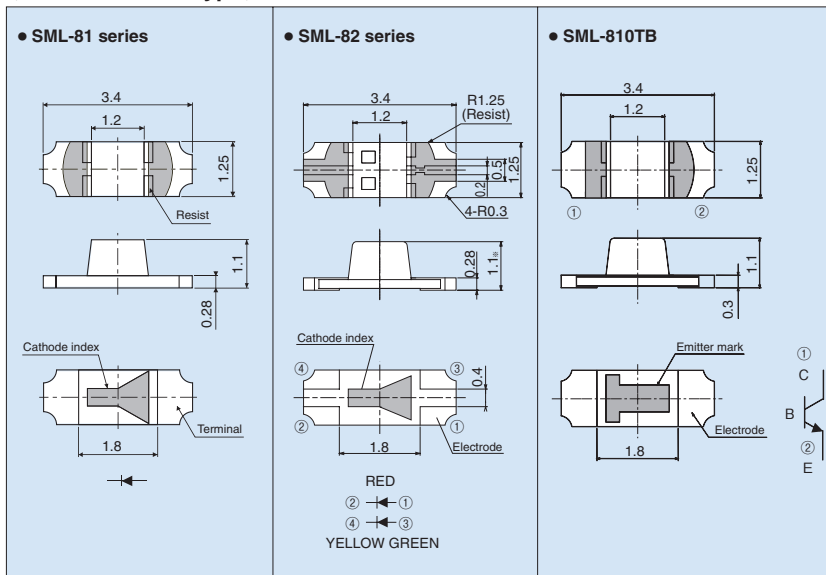

*For further information, please refer to the data sheets.

(Surface Mount Lens type)

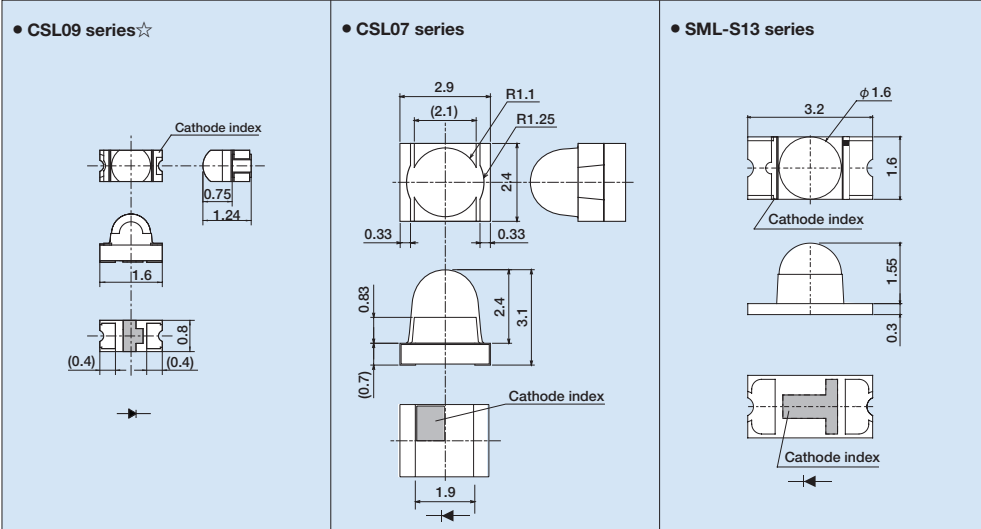

(2 color type)

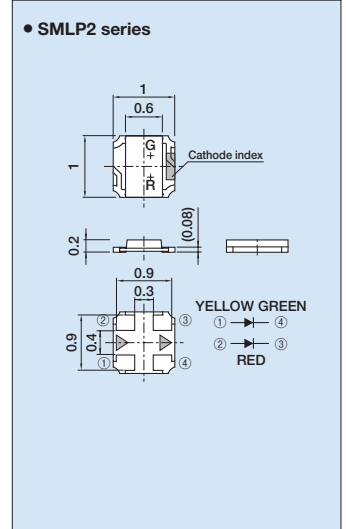

(2 Color type)

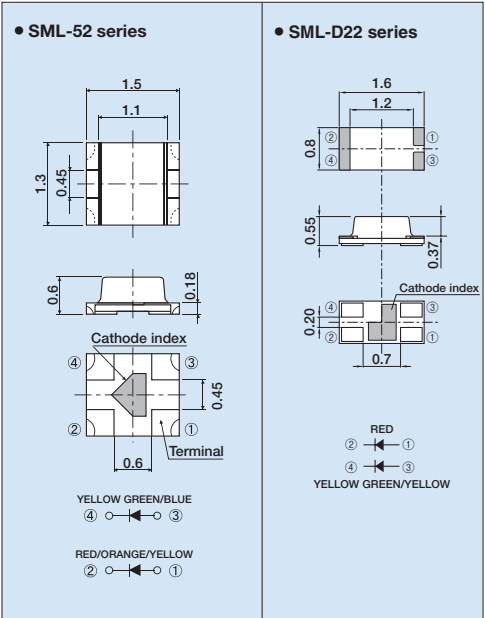

(3 Color type)

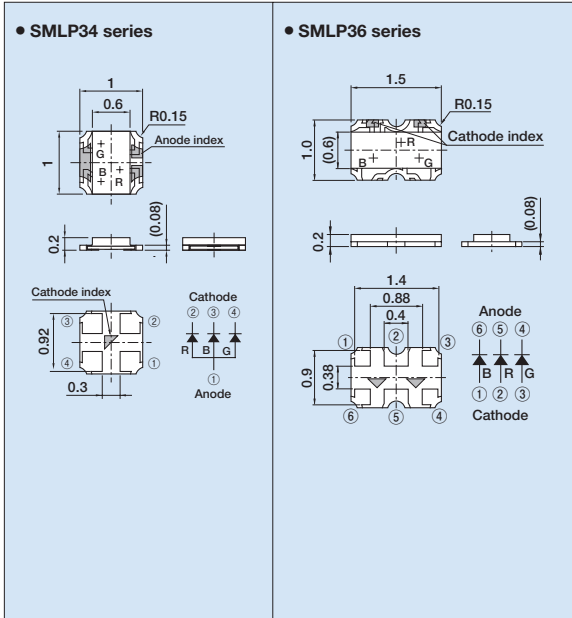

(3 Color type)

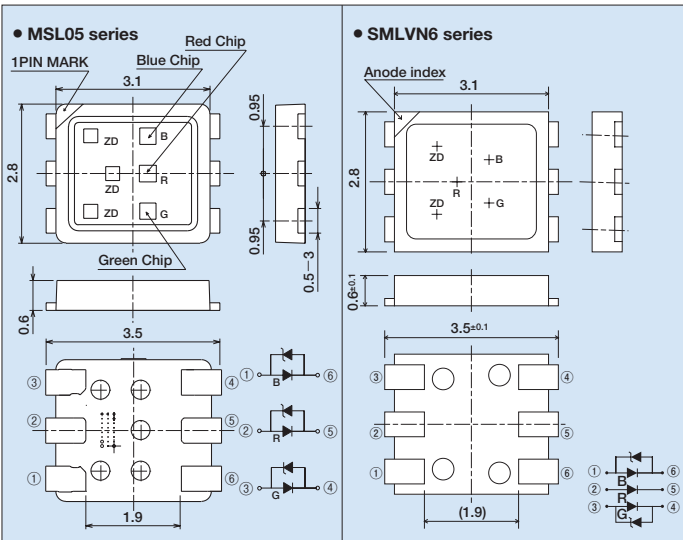

(3 Color Side View type)

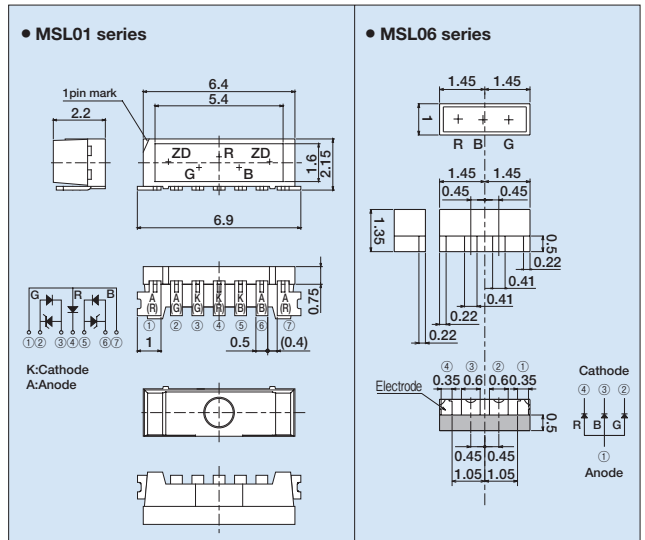

*For further information, please refer to the data sheets.
☆:Under Development

Through-hole LEDs

ROHM offers a wide variety of through-hole LEDs, including lamps that can be automatically mounted onto the PCB as well as high brightness units suitable for public outdoor displays.

Red(V,U) Quick Reference of Brightness

<High Brightness Rank Table>

XE	XF	XG	XH	XJ	XK	XL	XM	XN	XP	XQ	XR	XS	XT	XU
47 to 68	68 to 100	100 to 150	150 to 220	220 to 330	330 to 470	470 to 680	680 to 1000	1000 to 1500	1500 to 2200	2200 to 3300	3300 to 4700	4700 to 6800	6800 to 10000	10000 to 15000

Viewing angle (2θ1/2)	Resin Color	Brightness Rank Brightness (mcd) If (mA)	K	L	M	N	P	Q	R	S	T	U	V		
			4.0 to 6.3	6.3 to 10	10 to 16	16 to 25	25 to 40	40 to 63	63 to 100	100 to 160	160 to 250	250 to 400	400 to 630		
φ3 Circular type	40°	Transparent Colored	20									*SLI-343URC			
			10										SLI-343V8RC*		
		Diffused Colored	20										*SLI-343URC(W)		
			10												
	85°	Transparent Colored	20												
			10												
		Diffused Colored	20												
			10												
φ3 Circular type (Direct mount 5mm pitch type)	40°	Transparent Colored	20												
			10												
	Diffused Colored	20													
		10													
φ3 Flat disc type	35°	Transparent Colored	10												
	50°	Diffused Colored	10												
φ4 Oval type	140°	Diffused Colored	20												
	10°	Diffused Colored	20												
φ5 Circular type	20°	Transparent Colorless	20												
			10												
	40°	Transparent Colored	20												
			10												

Orange(D) Quick Reference of Brightness

<High Brightness Rank Table>

XE	XF	XG	XH	XJ	XK	XL	XM	XN	XP	XQ	XR	XS	XT	XU
47 to 68	68 to 100	100 to 150	150 to 220	220 to 330	330 to 470	470 to 680	680 to 1000	1000 to 1500	1500 to 2200	2200 to 3300	3300 to 4700	4700 to 6800	6800 to 10000	10000 to 15000

Viewing angle (2θ1/2)	Resin Color	Brightness Rank Brightness (mcd) If (mA)	J	K	L	M	N	P	Q	R	S	T	U	V		
			2.5 to 4.0	4.0 to 6.3	6.3 to 10	10 to 16	16 to 25	25 to 40	40 to 63	63 to 100	100 to 160	160 to 250	250 to 400	400 to 630		
φ3 Circular type	40°	Transparent Colored	20													
			10													
		Diffused Colored	20													
			10													
	85°	Transparent Colored	20													
			10													
		Diffused Colored	20													
			10													
φ3 Circular type (Direct mount 5mm pitch type)	40°	Transparent Colored	20													
			10													
	Diffused Colored	20														
		10														
φ3 Flat disc type	35°	Transparent Colored	10													
	50°	Diffused Colored	10													
φ4 Oval type	140°	Diffused Colored	20													
	10°	Diffused Colored	20													
φ5 Circular type	20°	Transparent Colorless	20													
			10													
	40°	Transparent Colored	20													
			10													

Yellow(Y) Quick Reference of Brightness

<High Brightness Rank Table>

XE	XF	XG	XH	XJ	XK	XL	XM	XN	XP	XQ	XR	XS	XT	XU
47 to 68	68 to 100	100 to 150	150 to 220	220 to 330	330 to 470	470 to 680	680 to 1000	1000 to 1500	1500 to 2200	2200 to 3300	3300 to 4700	4700 to 6800	6800 to 10000	10000 to 15000

Viewing angle (2θ1/2)	Resin Color	Brightness Rank Brightness (mcd) If (mA)	J	K	L	M	N	P	Q	R	S	T	U	V		
			2.5 to 4.0	4.0 to 6.3	6.3 to 10	10 to 16	16 to 25	25 to 40	40 to 63	63 to 100	100 to 160	160 to 250	250 to 400	400 to 630		
φ3 Circular type	40°	Transparent Colored	20													
			10													
		Diffused Colored	20													
			10													
	85°	Transparent Colored	20													
			10													
		Diffused Colored	20													
			10													
φ3 Circular type (Direct mount 5mm pitch type)	40°	Transparent Colored	20													
			10													
	Diffused Colored	20														
		10														
φ3 Flat disc type	35°	Transparent Colored	10													
	50°	Diffused Colored	10													
φ4 Oval type	140°	Diffused Colored	20													
	10°	Diffused Colored	20													
φ5 Circular type	20°	Transparent Colorless	20													
			10													
	40°	Transparent Colored	20													
			10													

*:Brightness on specification sheet include tolerance of within ±10%. *:This product refer to high brightness rank table.



<High Brightness Rank Table>

XA	XB	XC	XD	XE	XF	XG	XH	XJ	XK	XL	XM	XN	XP	XQ	XR	XS	XT	XU
10 to 15	15 to 22	22 to 33	33 to 47	47 to 68	68 to 100	100 to 150	150 to 220	220 to 330	330 to 470	470 to 680	680 to 1000	1000 to 1500	1500 to 2200	2200 to 3300	3300 to 4700	4700 to 6800	6800 to 10000	10000 to 15000

Green(M,P,E) Quick Reference of Brightness

	Viewing angle (2θ1/2)	Resin Color	Brightness Rank Brightness (mcd) If(mA)	J	K	L	M	N	P	Q	R	S	T	U	V				
				2.5 to 4.0	4.0 to 6.3	6.3 to 10	10 to 16	16 to 25	25 to 40	40 to 63	63 to 100	100 to 160	160 to 250	250 to 400	400 to 630				
φ3 Circular type	25°	Transparent Colorless	20									*SLA-370MT*							
		Transparent Colored	20										*SLI-343MC						
	10					SLI-343P8C*			*SLR-343MC				*SLI-343M8C*						
	40°	Diffused Colored	20										*SLI-343MG						
			10				SLI-343P8G*			*SLR-343MG				*SLI-343M8G*					
	85°	Diffused Colored Transparent Colored	20															*SLR343EC4T*	*SLR343ECT*
			10				*SLR-332MC			*SLA-360MT*									
	φ3 Circular type (Direct mount 5mm pitch type)	40°	Transparent Colored	10															
			Diffused Colored	10															
	φ3 Flat disc type	35°	Transparent Colored	10															
50°		Diffused Colored	10																
φ4 Oval type	140°	Diffused Colored	20									SLI-430MG*							
	10° 20°	Transparent Colorless	20														*SLA-580MT*	*SLA-570MT*	
φ5 Circular type	40°		Transparent Colored Diffused Colored	10															
		20																	
	10° 40°	Transparent Colorless	10																*SLA580EC4T*
			20																*SLA580ECT*
																		SLA560EC4T	
																		SLA560ECT	

Blue(B) Quick Reference of Brightness

	Viewing angle (2θ1/2)	Resin Color	Brightness Rank Brightness (mcd) If(mA)	XH	XJ	XK	XL	XM	XN	XP	XQ	XR	XS	XT	XU				
				150 to 220	220 to 330	330 to 470	470 to 680	680 to 1000	1000 to 1500	1500 to 2200	2200 to 3300	3300 to 4700	4700 to 6800	6800 to 10000	10000 to 15000				
φ3 Circular type	40°	Transparent Colorless	20																
φ4 Oval type	140°	Milky White	20																
φ5 Circular type	10°	Transparent Colorless	20																
	40°	Transparent Colorless	10																
			20																

White(WB) Quick Reference of Brightness

	Viewing angle (2θ1/2)	Resin Color	Brightness Rank Brightness (mcd) If(mA)	XJ	XK	XL	XM	XN	XP	XQ	XR	XS	XT	XU			
				220 to 330	330 to 470	470 to 680	680 to 1000	1000 to 1500	1500 to 2200	2200 to 3300	3300 to 4700	4700 to 6800	6800 to 10000	10000 to 15000			
φ3 Circular type	40°	Transparent Colorless	20														
φ4 Oval type	140°	Milky White	20														
φ5 Circular type	40°	Transparent Colorless	20														

※:Brightness on specification sheet include tolerance of within ±10%.

★:This product refer to high brightness rank table.



Through-hole LEDs

(φ3 type)																																														
Shape	Package Image	Viewing Angle 2θ1/2 (Element type)	Part No.	Emitting Color	Absolute Maximum Ratings(Ta=25°C)							Electrical and Optical Characteristics(Ta=25°C)							Automotive Grade AEC-Q101																											
					Power Dissipation Pd (mW)	Forward Current If (mA)	Peak Forward Current Ifp (mA)	Reverse Voltage Vr (V)	Operating Temperature Topr (°C)	Storage Temperature Tstg (°C)	Forward Voltage Vf (V)	Reverse Current Ir (mA)	Max. Ir (μA)	Vr (V)	Peak Wavelength λp/ Chromaticity Coordinates(x,y)		Luminous Intensity Iv																													
φ3 Circular type		40°	SLI-343V8RC	Red	54	20	100*2	-30 to +85	-40 to +100	2.2	10	9	9	639	20	150	330	—																												
			SLI-343V8R													100	220																													
			SLI-343U8RC													150	330																													
			SLI-343U8R													100	220																													
			SLI-343D8C	Orange												330	680																													
			SLI-343D8U													220	470																													
			SLI-343Y8C	Yellow												330	680																													
			SLI-343Y8Y													220	470																													
			SLI-343M8C	Yellow Green												68	150																													
			SLI-343M8G																																											
			SLI-343P8C	Green												10	22																													
			SLI-343P8G																																											
			High brightness	40°												SLI-343URC	Red		125	50	200*2	-25 to +85	1.9	20	100	5	5	630	20	450	350	—														
																SLI-343UR														500																
	SLI-343DC	90			350																																									
	SLI-343DU	300			680																																									
	SLI-343YC	Yellow			56	200																																								
	SLI-343YY						180																																							
	SLI-343MC	Yellow Green			220	1,000																																								
	SLI-343MG						330	1,000																																						
	SLR343BC7T	Blue			220	1,000																																								
	SLR343BD2T						330	1,000																																						
	SLR343WBC7T	White			1,500	3,300																																								
	SLR343WBD2PT																																													
	Standard	40°			SLR-343VC	Red	60	20	60*1	3	-25 to +85	-30 to +100	10	3	10	650	10	9												25	—															
					SLR-343VR													6												16																
			SLR-343DC	9	25																																									
			SLR-343DU	6	16																																									
			SLR-343YC	Yellow	4	10																																								
			SLR-343YY															6	16																											
			SLR-343MC	Yellow Green	9	25																																								
			SLR-343MG															6	16																											
			SLR-343PC	Green	2	6																																								
			SLR-343PG																																											
			SLR343ECT	Blue	900	2,200																																								
			SLR343EC4T															420	1,500																											
			SLR343BCT															200	600																											
			SLR343BC4T															470																												
	Low current	40°	SLI-343URC(W)	Red	125	50	200*2	9	-25 to +85	1.9	20	100	9	630	20	36	200	20																												
			SLI-343UR(W)													160																														
			SLI-343DC(W)	56												300																														
			SLI-343DU(W)	250																																										
			SLI-343YC(W)	200												470																														
			SLI-343YY(W)	36												160																														
25° High brightness	40° High brightness	SLA-370MT	Yellow Green	75	25	60*1	4	-25 to +85	-30 to +100	2.3	20	10	4	563	20	42	100	20	—																											
		SLA-360MT																																												
Standard	85°	SLR-332VC	Red	60	20	60*1	3	-25 to +85	-30 to +100	10	10	3	650	10	4	10	—																													
		SLR-332VR													6	16																														
		SLR-332DC													4	10																														
		SLR-332DU													4	10																														
		SLR-332YC	Yellow												2	6																														
		SLR-332YY																																												
		SLR-332MC	Yellow Green												6	16																														
		SLR-332MG																																												
		High brightness	10°												SLI-580UT	Red		125	50	200*2	9	-30 to +85	-40 to +100	1.9	100	9	630	20	2,000	5,000	—															
															SLI-580DT														611																	
															SLI-580YT														591																	
															SLA-580MT	Yellow Green													75			25	60*1	4	-25 to +85		2.3	20	10	4	563	20	200	470	20	—
															SLA580ECT	Green													3,000			8,000														
															SLA580EC4T																		2,000	4,500												
SLA580BCT	Blue			900	2,500																																									
SLA580BC4T						610	1,500																																							
High brightness	20°			SLI-570UT	Red	125	50	200*2	9	-30 to +85	-40 to +100	1.9	20	100	9	630	20												900			3,000	—													
				SLI-570U2T																									2,200			4,000														
				SLI-570DT																									900			3,000														
				SLI-570YT	Yellow																								610			2,500														
				SLI-570Y2T																														2,200	5,200											
				SLA-570MT	Yellow Green																								75			25		60*1	4	-25 to +85	-30 to +100	2.1		10	4	563	200	470		
		High brightness	40°	SLI-560UT	Red													125	50	200*2	9	-30 to +85	-40 to +100	1.9	100	9	630	20	300	1,000	—															
				SLI-560DT																									611																	
				SLI-560YT																									591																	
				SLA-560MT	Yellow Green																								75	25		60*1		4	-25 to +85		2.3		4	563	42	100				
				SLA560BD2T	Blue																								1,000	2,200																
				SLA560WBD2PT																												1,500		3,300												
				Standard	40°																								SLA560ECT	Green		120		30	100*2	5	-20 to +80		3.3	100	5	518	20	610	2,000	—
																													SLA560EC4T															1,500		
SLA560BCT	200					600																																								
SLA560BC4T	470																																													
SLR-56VC	Red					60	20	60*1	3	-25 to 85	-30 to +100	2.0		10	10	3	650												10	9			25											—		
SLR-56VR																														4			10													
SLR-56DC																														9			25													
SLR-56DU																														4			10													
SLR-56YC	Yellow	6	16																																											
SLR-56YY																																														
SLR-56MC	Yellow Green	14	40																																											
SLR-56MG																		6	16																											

*1:Duty1/5, 200Hz *2:Duty1/10, 1kHz *3:Dominant Wavelength

Oval type																												
Shape	Package Image	Viewing Angle 2θ1/2 (Element type)	Part No.	Emitting Color	Absolute Maximum Ratings(Ta=25°C)						Electrical and Optical Characteristics(Ta=25°C)					Automotive Grade AEC-Q101												
					Power Dissipation Pd (mW)	Forward Current If (mA)	Peak Forward Current Ifp (mA)	Reverse Voltage Vr (V)	Operating Temperature Topr (°C)	Storage Temperature Tstg (°C)	Forward Voltage Vf (V)	Reverse Current Ir (μA)	Vr (V)	Peak Wavelength λp/ Chromaticity Coordinates(x,y)			Luminous Intensity Iv											
Oval type φ4		140°	Standard	SLI-430U2R	Red	75	30	100*2	9	-40 to +85	-40 to +100	2.0	20	10	9	620*3		220	400	—								
				SLI-430DU	Orange											605*3					20	470						
				SLI-430Y2U	Yellow											590*3							330	500				
				SLI-430MG	Yellow Green											570*3									68	120		
				SLD430BD2W	Blue											470*3											330	560
				SLD430WBD2PT	White											(x,y)(0.31,0.31)												
Others																												
φ3.2 Circular type		40°	Low current	SLI-325URC(W)*	Red	48	20	60*1	-25 to +85	-30 to +100	1.9	20	100	4	630		20	36	160	100								
				SLI-325UR(W)*	Orange										611						160	100						
				SLI-325DC(W)*	Orange										591								160	100				
				SLI-325DU(W)*	Yellow										591										160	100		
				SLI-325YC(W)*	Yellow Green										591												160	100
				SLI-325YY(W)*	Yellow										591													
Standard	SLR-325VC*	Red	60	25	3	-25 to +85	-30 to +100	2.0	10	10	3	650		10	6	16	—											
	SLR-325VR*	Orange										610						6	16									
	SLR-325DC*	Orange										610								4	10							
	SLR-325DU*	Yellow										585										6	16					
	SLR-325YC*	Yellow Green										585												2	6			
	SLR-325YY*	Yellow										585														9	25	
SLR-325MC*	Yellow Green	563		6	16																							
SLR-325MG*	Yellow Green	563				6	16																					
Standard	SLR-322VC	Red	60					20	3	-25 to +85	-30 to +100	2.0	10	10	3	650		10	6	16	—							
	SLR-322DC	Orange														610						4	10					
	SLR-322YC	Yellow														585								9	25			
	SLR-322MC	Yellow Green														563										4	10	
	SLR-322VR	Red		650												2	6											
	SLR-322DU	Orange		610		4	10																					
SLR-322YY	Yellow	585		4	10																							
SLR-322MG	Yellow Green	563						6	16																			

* SLI-325/SLR-325 series : straight taping only.
*1:Duty1/5, 200Hz *2:Duty1/10, 1kHz *3:Dominant Wavelength

● Part No. Configuration (Through-hole LEDs)

■ Exclude Mono-color(Blue(B), Green(E), White(WB))

Chip control symbol Remarks Special control symbol

S L I - 3 4 3 V **8 R C 3 F** [] [] []

Series name Package shape Color Resin color Terminal shape and taping specifications Brightness rank

SLA 1-Die Circular type High Brightness LED Lamps	343 φ3 Circular type	V Red	R <Red>-Diffused colored	3F 1-Die straight bulk	Refer to specification
SLI 1-Die Circular type Low Current High Brightness LED Lamps	360 φ3 Circular type	U Red	U <Orange>-Diffused colored	T31 Refer to taping specification	
SLR 1-Die Circular type LED Lamp	370 φ3 Circular type	U2 Red	Y <Yellow>-Diffused colored	T32	Refer to specification
	56 φ5 Circular type	D Orange	G <Yellowish green>-Diffused colored		
	570 φ5 Circular type	Y Yellow	C Transparent colored		
	580 φ5 Circular type	Y2 Yellow	T Transparent colorless		
	430 Oval type φ4	M Yellowish green			
	325 φ3.2 Circular type	P Green			
	322 φ3 Flat disc type				

■ Mono-color(Blue(B), Green(E), White(WB))

Chip control symbol Remarks Chromaticity rank(for white LED)
*SLA560WBD2PT is not applied. Special control symbol

S L R 3 4 3 W B D **2 P T 2** [] [] []

Series name Package shape Color Resin color Terminal shape and taping specifications Brightness rank

SLA 1-Die Circular type High Brightness LED Lamps	343 φ3 Circular type	BC Blue	T Transparent colorless	3F 1-Die straight bulk	Refer to specification
SLI 1-Die Circular type LED Lamps	560 φ5 Circular type	BD Blue	W Milky white	T31 Refer to specification	
SLR 1-Die Circular type LED Lamps	580 φ5 Circular type	EC Green		T32	Refer to specification
SLD 1-Die Oval type High Brightness LED Lamps	430 Oval type φ4	ED Green			
		WBx White			

(in case of white)

3 1-Die straight bulk
1 Refer to specification(same as T31)
2 Refer to specification(same as T32)

Through-hole LEDs

● Viewing Angle (Unit:deg)

⟨ $\phi 3$ type ⟩

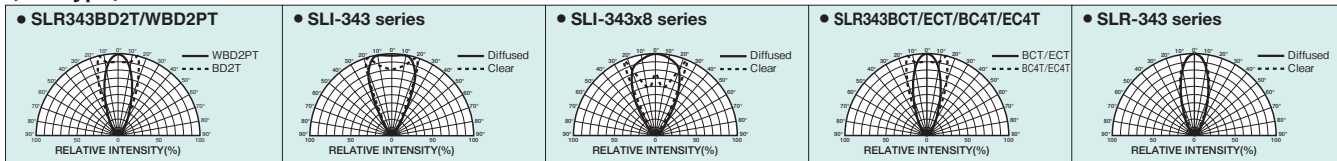

⟨ $\phi 3$ type ⟩

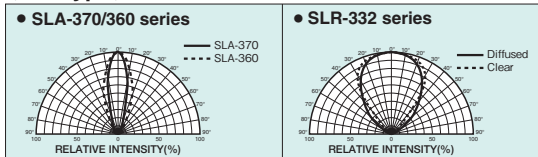

⟨ $\phi 5$ type ⟩

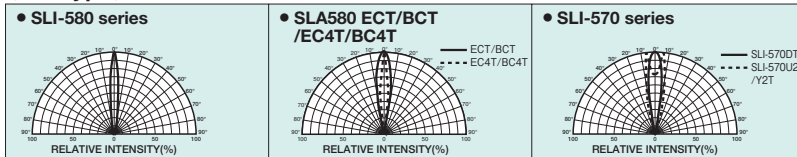

⟨ $\phi 5$ type ⟩

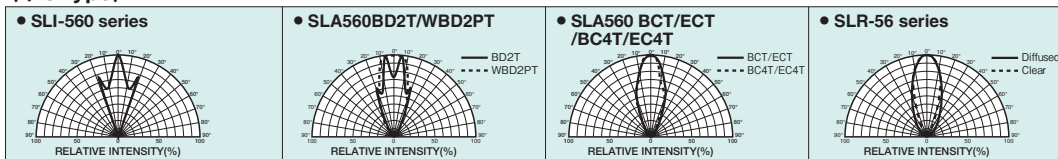

⟨ Oval type ⟩

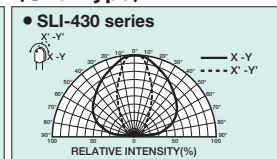

⟨ Oval Type ⟩

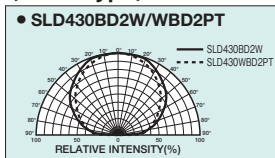

⟨ Others ⟩

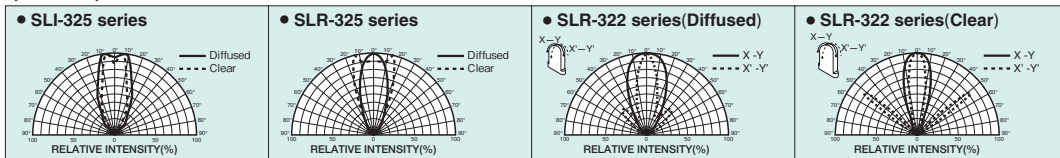

Notes: Viewing Angle shown above are the reference data from standard product. For the part numbers other than the above, please contact us.

● Dimensions (Unit:mm)

⟨ $\phi 3$ type ⟩

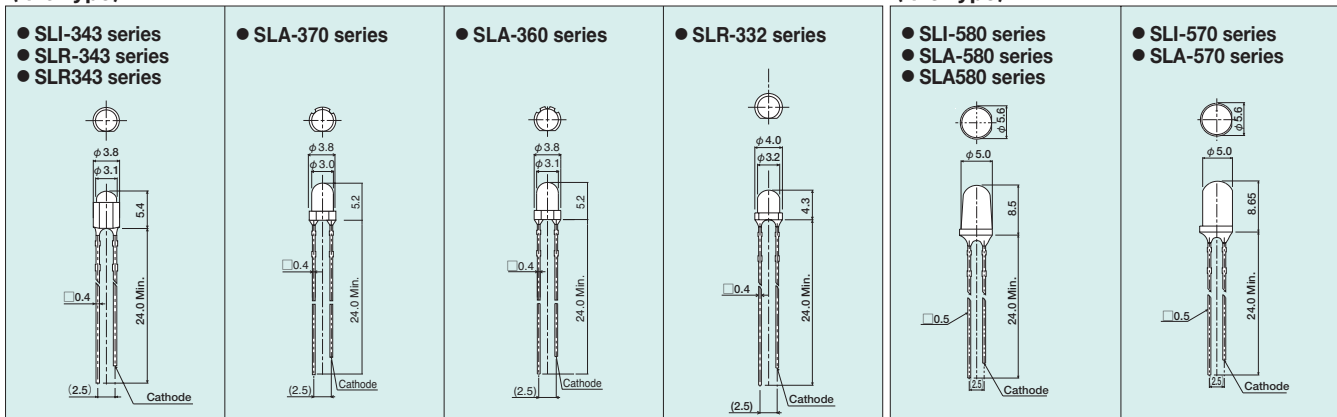

⟨ $\phi 5$ type ⟩

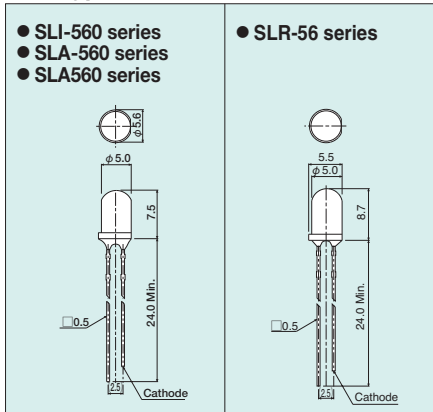

⟨ Oval type ⟩

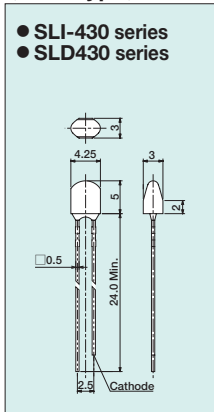

⟨ Others ⟩

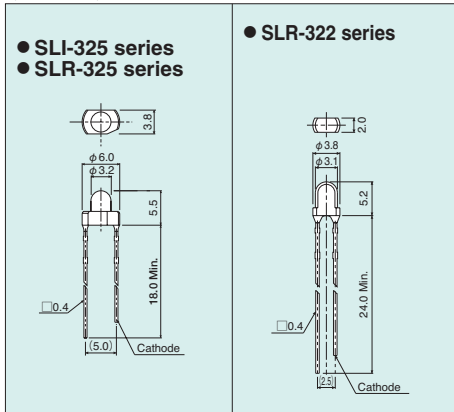

*For further information, please refer to specification.



Opto Devices

LED Displays

CONTENTS

■ High Brightness LED Numeric Displays	P. E18
■ LED Numeric Displays	P. E18
Single Digit LED Numeric Displays (Surface Mount type)	P. E18
Single Digit LED Numeric Displays	P. E19
Two Digit LED Numeric Displays	P. E19
Three Digit LED Numeric Displays	P. E19

High Brightness LED Numeric Displays

High brightness, low power consumption, and high reliability.

High Brightness LED Numeric Displays																		
Shape	Part No.	Emitting Color	Absolute Maximum Ratings(Ta=25°C)				Absolute Maximum Ratings		Electrical and Optical Characteristics(Ta=25°C)									
			Power Dissipation P _o (mW)	Forward Current I _F (mA)	Peak Forward Current I _{FP} * (mA)	Reverse Voltage V _R (V)	Operating Temperature Topr (°C)	Storage Temperature Tstg (°C)	Forward Voltage V _F		Reverse Current I _R		Light Wavelength Peak Half-wave		Brightness/Digit I _v			
									Typ. (V)	I _F (mA)	Max. (μA)	V _R (V)	λ _p Typ. (nm)	Δλ Typ. (nm)	I _F (mA)	Min. (mcd)	Typ. (mcd)	I _F (mA)
Character Height:8mm External Dimensions:(7×11)	LAP-301VB/VL	Red													14	36		
	LAP-301MB/ML	Green	448	20	60	5	-25 to +75	-30 to +85	1.9	10	100	3	572	20	10	36	100	10
	LAP-301DB/DL	Orange													56	250		
Character Height:10.16mm External Dimensions:(9.6×13)	LAP-401VD/VN	Red													14	36		
	LAP-401MD/MN	Green	448	20	60	5	-25 to +75	-30 to +85	1.9	10	100	3	572	20	10	36	100	10
	LAP-401DD/DN	Orange													56	250		
Character Height:14.6mm External Dimensions:(12.5×19)	LAP-601VB/VL	Red													14	36		
	LAP-601MB/ML	Green	448	20	60	5	-25 to +75	-30 to +85	1.9	10	100	3	572	20	10	36	100	10
	LAP-601DB/DL	Orange													56	250		
Character Height:14.3mm External Dimensions:(25×19)	LBP-602VA2/VK2	Red													14	36		
	LBP-602MA2/MK2	Green	896	20	60	5	-25 to +75	-30 to +85	1.9	10	100	3	572	20	10	36	100	10
	LBP-602DA2/DK2	Orange													56	250		

Notes:*I_{FP} measured under duty ≤ 1/5, Pulse width ≤ 1ms

LED Numeric Displays

ROHM's LED numeric displays are compatible with automatic reflow processes.

Single Digit LED Numeric Displays(Surface Mount type)																		
Shape	Part No.	Emitting Color	Absolute Maximum Ratings(Ta=25°C)				Absolute Maximum Ratings		Electrical and Optical Characteristics(Ta=25°C)									
			Power Dissipation P _o (mW)	Forward Current I _F (mA)	Peak Forward Current I _{FP} * (mA)	Reverse Voltage V _R (V)	Operating Temperature Topr (°C)	Storage Temperature Tstg (°C)	Forward Voltage V _F		Reverse Current I _R		Light Wavelength Peak Half-wave		Brightness/Digit I _v			
									Typ. (V)	I _F (mA)	Max. (μA)	V _R (V)	λ _p Typ. (nm)	Δλ Typ. (nm)	I _F (mA)	Min. (mcd)	Typ. (mcd)	I _F (mA)
Character Height:8mm External Dimensions:(6.8×11)	LF-3011VA/VK	Red	320	15	60	5	-25 to +75	-30 to +85	2.0	10	100	3	650	40	10	3.6	10	10
	LF-3011MA/MK	Green	480	20					2.1				563					

Notes:*I_{FP} measured under duty ≤ 1/5, Pulse width ≤ 1ms

These single digit numeric displays are 8 to 25.4mm in height and available in a range of colors.

Single Digit LED Numeric Displays																		
Shape	Part No.	Emitting Color	Absolute Maximum Ratings(Ta=25°C)				Absolute Maximum Ratings		Electrical and Optical Characteristics(Ta=25°C)									
			Power Dissipation P _o (mW)	Forward Current I _F (mA)	Peak Forward Current I _{Fp} * (mA)	Reverse Voltage V _R (V)	Operating Temperature T _{opr} (°C)	Storage Temperature T _{stg} (°C)	Forward Voltage V _F		Reverse Current I _R		Light Wavelength Peak Half-wave			Brightness/Digit I _v		
								Typ. (V)	I _F (mA)	Max. (μA)	V _R (V)	λ _p Typ. (nm)	Δλ Typ. (nm)	I _F (mA)	Min. (mcd)	Typ. (mcd)	I _F (mA)	
	LA-301VB/VL	Red	320	15	60			2.0	10			650	40	10	3.6	10		
	LA-301MB/ML	Green	480	20	60			2.1	10			563	40	10	5.6	16		
	LA-301AB/AL	High Brightness Red	520	25	50			2.05	20			626	18	20	36	90		
	LA-301EB/EL	High Brightness Orange	520	25	50			2.05	20			610	17	20	36	90		
	LA-401VD/VN	Red	320	15	60			2.0	10			650	40	10	5.6	16		
	LA-401MD/MN	Green	480	20	60			2.1	10			563	40	10	5.6	16		
	LA-401AD/AN	High Brightness Red	520	25	50			2.05	20			626	18	20	36	90		
	LA-401ED/EN	High Brightness Orange	520	25	50			2.05	20			610	17	20	36	90		
	LA-501VD/VN	Red				5	-25 to +75	-30 to +85	2.0		100	3	650					10
	LA-501MD/MN	Green							2.1				563					16
	LA-601VB/VL	Red	480	20	60				2.0	10			650	40	10			14
	LA-601MB/ML	Green							2.1				563					22
	LA-601AB/AL	High Brightness Red	520	25	50				2.05	20			626	18	20	36	90	
	LA-601EB/EL	High Brightness Orange	520	25	50				2.05	20			610	17	20	36	90	
	LA-101VA/VK	Red		15	60				4.0				650					3.6
	LA-101MA/MK	Green	640	20	60				4.2	10			563	40	10			5.6

Notes: *I_{Fp} measured under duty ≤ 1/5, Pulse width ≤ 1ms, High Brightness and Blue I_{Fp} measured under duty ≤ 1/10, Pulse width ≤ 0.1 ms 2) LA-101 series : order-based production

These two digit numeric displays are 10.16 to 14.3mm in height and available in a range of colors.

Two Digit LED Numeric Displays																		
Shape	Part No.	Emitting Color	Absolute Maximum Ratings(Ta=25°C)				Absolute Maximum Ratings		Electrical and Optical Characteristics(Ta=25°C)									
			Power Dissipation P _o (mW)	Forward Current I _F (mA)	Peak Forward Current I _{Fp} * (mA)	Reverse Voltage V _R (V)	Operating Temperature T _{opr} (°C)	Storage Temperature T _{stg} (°C)	Forward Voltage V _F		Reverse Current I _R		Light Wavelength Peak Half-wave			Brightness/Digit I _v		
								Typ. (V)	I _F (mA)	Max. (μA)	V _R (V)	λ _p Typ. (nm)	Δλ Typ. (nm)	I _F (mA)	Min. (mcd)	Typ. (mcd)	I _F (mA)	
	LB-402VD/VN	Red	640	15				2.0				650			5.6	16		
	LB-402MD/MN	Green			60	5	-25 to +75	-30 to +85	2.1	10			563	40	10	9.0	25	
	LB-502VD/VN	Red	960	20				2.0				650			5.6	16		
	LB-502MD/MN	Green						2.1				563			9.0	25		
	LB-602VA2/VK2	Red						2.0		100	3	650			5.6	16		
	LB-602MA2/MK2	Green						2.1	10			563	40	10	9.0	25		
	LB-602AA2/AK2	High Brightness Red				5	-25 to +75	-30 to +85					626	18				
	LB-602EA2/EK2	High Brightness Orange	1,040	25	50				2.05	20			610	17	20	36	90	

Notes: *I_{Fp} measured under duty ≤ 1/5, Pulse width ≤ 1ms, High Brightness and Blue I_{Fp} measured under duty ≤ 1/10, Pulse width ≤ 0.1 ms

Three Digit LED Numeric Displays																		
Shape	Part No.	Emitting Color	Absolute Maximum Ratings(Ta=25°C)				Absolute Maximum Ratings		Electrical and Optical Characteristics(Ta=25°C)									
			Power Dissipation P _o (mW)	Forward Current I _F (mA)	Peak Forward Current I _{Fp} * (mA)	Reverse Voltage V _R (V)	Operating Temperature T _{opr} (°C)	Storage Temperature T _{stg} (°C)	Forward Voltage V _F		Reverse Current I _R		Light Wavelength Peak Half-wave			Brightness/Digit I _v		
								Typ. (V)	I _F (mA)	Max. (μA)	V _R (V)	λ _p Typ. (nm)	Δλ Typ. (nm)	I _F (mA)	Min. (mcd)	Typ. (mcd)	I _F (mA)	
	LB-603VF/VP	Red	960	15	60	5	-25 to +75	-30 to +85	2.0	10	100	3	650	40	10	5.6	16	10

Notes: *I_{Fp} measured under duty ≤ 1/5, Pulse width ≤ 1ms



Opto Devices

Laser Diodes

CONTENTS

■ Red/Infrared Dual Wavelength Lasers	P. E22
■ Red Lasers	P. E22
■ Infrared Lasers	P. E23
■ Part Numbers, Symbols and Definitions ...	P. E24
■ Packaging Specifications	P. E26

Laser Diodes

Red/Infrared Dual Wavelength Lasers															
Part No.	Pitch (μm)	Wavelength λ _P (nm)	Absolute Maximum Ratings (T _c =25°C)			Electrical and Optical Characteristics (T _c =25°C)							P _o (mW)	Package	Equivalent Circuit
			P _o (mW)	V _R (V)	T _{opr} Max. (°C)	I _{TH} (mA)	I _{op} (mA)	η (W/A)	V _{op} (V)	I _m (mA)	θ _⊥ (deg.)	θ// (deg.)			
RLD2WMNL2-00x (For Automotive)	110	663	7	2	85	18	24	0.70	2.3	0.25	28.0	10.0	5		
		785	7	2	85	15	20	0.70	1.8	0.25	32.0	10.0	5		
RLD2WMNL2-01x (Standard)	110	663	7	2	80	18	24	0.70	2.3	0.25	28.0	10.0	5		
		785	7	2	80	15	20	0.70	1.8	0.25	32.0	10.0	5		

Notes :1.Unless otherwise specified, the Electrical and Optical Characteristics are typical values.
2.The Control number is applied in the x of part No.

Red Lasers														
Part No.	Wavelength λ _P (nm)	Absolute Maximum Ratings (T _c =25°C)			Electrical and Optical Characteristics (T _c =25°C)							P _o (mW)	Package	Equivalent Circuit
		P _o (mW)	V _R (V)	T _{opr} Max. (°C)	I _{TH} (mA)	I _{op} (mA)	η (W/A)	V _{op} (V)	I _m (mA)	θ _⊥ (deg.)	θ// (deg.)			
RLD65MZT7	655	7	2	70	20	30	0.70	2.3	0.24	27.0	8.0	5		
RLD65MQX1 (Higher ESD)	660	10	2	70	15	21	0.85	2.3	0.15	27.0	9.0	5		
RLD63NZC5 (Pure red)	635	6	2	40	24	33	0.55	2.2	0.18	32.0	8.0	5		
RLD63NPC5 (Pure red)	635	6	2	40	24	33	0.55	2.2	0.18	32.0	8.0	5		
RLD63NPC6 (Pure red)	635	12	2	50	25	40	0.65	2.3	0.13	31.0	8.0	10		
RLD63NPC7 (Pure red)	638	17	2	50	35	57	0.60	2.3	0.20	30.0	8.0	15		
RLD63NPC8 (Pure red)	638	24	2	50	35	67	0.60	2.3	0.25	29.0	8.0	20		
New RLD65NZX1 (Higher temp.)	660	10	2	85	15	24	0.85	2.3	0.30	27.0	9.0	7		
RLD65NZX2 (Higher ESD)	655	7	2	70	25	33	0.60	2.3	0.20	28.0	8.5	5		
New RLD65NZX3 (Higher ESD)	655	12	2	70	25	42	0.60	2.3	0.20	28.0	8.5	10		
RLD65PZX2 (Higher ESD)	655	7	2	70	25	33	0.60	2.3	0.20	28.0	8.5	5		
RLD65PZX3 (Higher ESD)	655	12	2	70	25	42	0.60	2.3	0.20	28.0	8.5	10		

Note: Unless otherwise specified, the Electrical and Optical Characteristics are typical values.

E Laser Diodes



Infrared Lasers															
Part No.	Wavelength λ_p (nm)	Absolute Maximum Ratings (Tc=25°C)			Electrical and Optical Characteristics (Tc=25°C)								P _o (mW)	Package	Equivalent Circuit
		P _o (mW)	V _R (V)	T _{opr} Max. (°C)	I _{TH} (mA)	I _{op} (mA)	η (W/A)	V _{op} (V)	I _m (mA)	θ_{\perp} (deg.)	$\theta_{//}$ (deg.)				
RLD78MZA6	790	4.5	2	70	25	35	0.35	1.9	0.15	37.0	11.0	3			
RLD78MZM7	792	20	2	60	11	33	0.65	1.8	0.50	24.0	8.5	15			
RLD78NZM5	793	10	2	60	11	20	0.55	1.8	1.15	28.0	9.0	6			
RLD78NZM7	792	20	2	60	11	33	0.65	1.8	0.90	24.0	8.5	15			
RLD82NZJ1	822	220	2	60	50	255	0.95	2.4	0.30	17.0	9.5	200			
RLD84NZJ2	842	220	2	60	50	255	0.95	2.4	0.30	17.0	9.5	200			
RLD85NZJ4	852	220	2	60	50	255	0.95	2.4	0.30	17.0	9.5	200			
☆RLD94NZJ5	942	285	2	65	55	325	0.75	2.2	0.90	30.0	35.0	200			
New RLD94NZJ7	942	220	2	60	50	255	0.95	2.4	0.30	17.0	9.5	200			
RLD78PZM7	792	20	2	60	11	33	0.65	1.8	0.65	24.0	8.5	15			
RLD82PZJ1	822	220	2	60	50	255	0.95	2.4	0.30	17.0	9.5	200			
RLD84PZJ2	842	220	2	60	50	255	0.95	2.4	0.30	17.0	9.5	200			
RLD85PZJ4	852	220	2	60	50	255	0.95	2.4	0.30	17.0	9.5	200			
☆RLD94PZJ5	942	285	2	65	55	325	0.75	2.2	0.90	30.0	35.0	200			
New RLD94PZJ7	942	220	2	60	50	255	0.95	2.4	0.30	17.0	9.5	200			

Note: Unless otherwise specified, the Electrical and Optical Characteristics are typical values.

☆: Under Development

●Safety

The light emitted from laser diodes, can cause retinal damage if viewed directly. Never look directly into the laser beam or through any lenses or fibers when the system is operating. For optical axis alignment or other operations, we recommend the use of an infrared-sensitive camera (ITV) or wearing protective goggles.

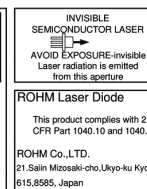
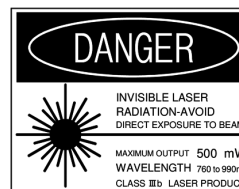
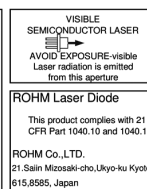
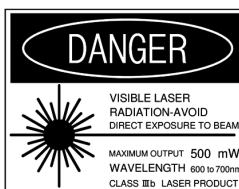

The products described in this specification are designed to be used with ordinary electronic equipment or devices (such as audio-visual equipment, office-automation equipment, communication device, electrical appliances, and electronic toys). If you intend to use these products or devices which require an extremely high level of reliability and malfunction of which would directly endanger human life (such as medical instruments, transportation equipment, aerospace machinery, nuclear-reactor controllers, fuel controllers and other safety devices), please be sure to consult with our sales representative in advance.

●About open package products.

With the open package product (package mark is P), the external environment could deteriorate the characteristics and reliability of LD. Please be careful to foreign matter including toner, human substance and smoke, corrosion due to ion, the volatilization component from the glue and flux, condensation, optical tweezers effect, etc. Do not touch the components including the laser chip emission point.

● Part Numbers

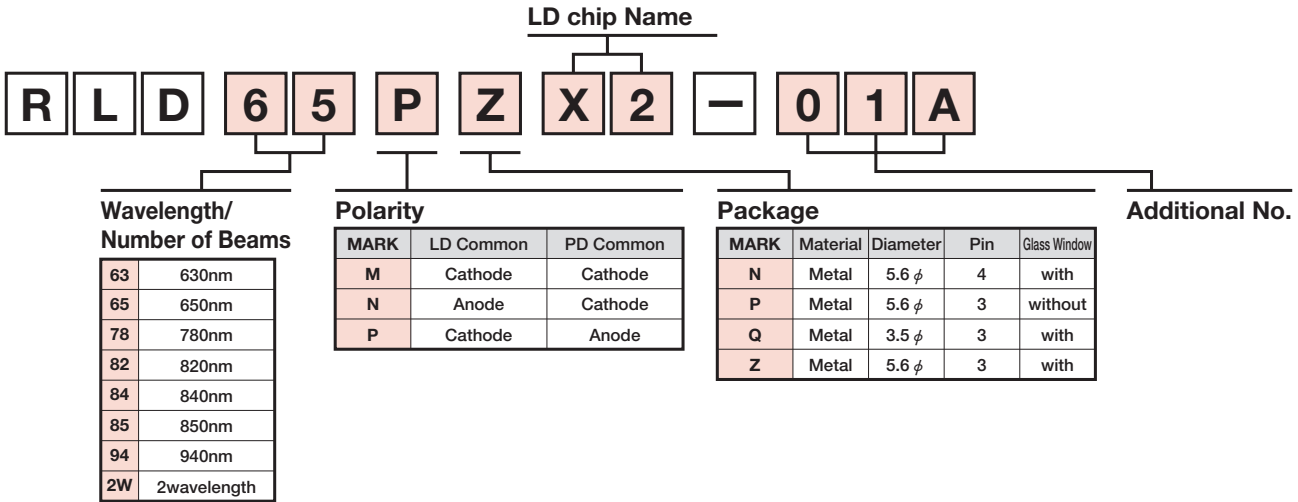

● Symbols and Definitions

■ Absolute maximum ratings

Absolute maximum ratings are values which must not be exceeded even momentarily regardless of external conditions.

These values are specified for a case temperature T_c of 25°C.

Parameter	Symbol	Definition
Optical Output	P_o	Maximum allowable optical output during continuous or pulse operation. No kinks will appear in the output vs. forward current curve up to this output value. (Fig.1)
Reverse Voltage	V_R	The maximum allowable voltage when a reverse bias is applied to the device. Lasers and photo diodes are rated separately.
Operating Temperature	T_{opr}	Allowed ambient temperature range when the device is in operation. Delined to be the case temperature of the device.
Storage Temperature	T_{stg}	Allowed temperature range when the device is being stored.

■ Fig.1 Optical Output vs. Forward Current

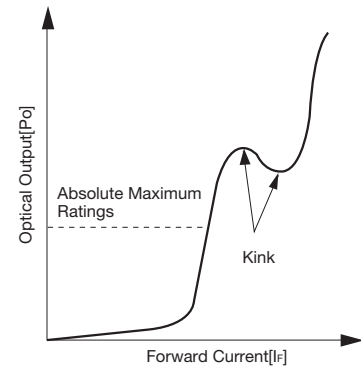

■ Electrical and Optical Characteristics

Item	Symbol	Definition
Threshold Current	I_{th}	In Fig.2, A is the spontaneous emission range and B is the stimulated emission range. The threshold current is the current at which laser emission begins.
Operating Current	I_{op}	The forward current required to generate the specified optical output.
Operating Voltage	V_{op}	The forward voltage required to generate the specified optical output.
Differential Efficiency	η	The average increase in the output per unit of drive current. In the laser emission range, this is the slope of the linear optical output vs. forward current curve. (Fig.2)
Monitor Current	I_m	When the specified optical output is generated, this is the output current of the photodiode when a specified reverse voltage is applied to the monitor photodiode.
Parallel Divergence Angle Perpendicular Divergence Angle	$\theta_{//}$ θ_{\perp}	Light emitted from the laser spreads as shown in Fig.3. The result of measurements of this spread in the parallel (x) and perpendicular (y) directions with respect to the junction surface is shown in Fig.3. The widths of the spread at the points where the strength drops to 1/2 the peak strength (half value full angles) are defined as angles and called $\theta_{//}$ and θ_{\perp} . (Fig.4)
Parallel Deviation Angle Perpendicular Deviation Angle	$\Delta \phi_{//}$ $\Delta \phi_{\perp}$	These values express the deviation of the optical axis with respect to the reference plane, and are defined for the parallel and perpendicular spread angles (Fig.4) to be $(a - b)/2$ (Fig.5).
Emission Point Accuracy	$\Delta X, \Delta Y, \Delta Z$	This indicates the amount of deviation of the emission point. ΔX and ΔY indicate deviation from the center of the package, and ΔZ indicates deviation from the reference plane. (Fig.6)
Peak Emission Wavelength	λ	Peak emission wavelength when generating the specified output. As shown in Fig.7, the emission spectrum has both a single mode and a multimode. In the multimode, the wavelength is defined as the wavelength with the highest intensity.

Fig.2 Optical Output vs. Forward Current

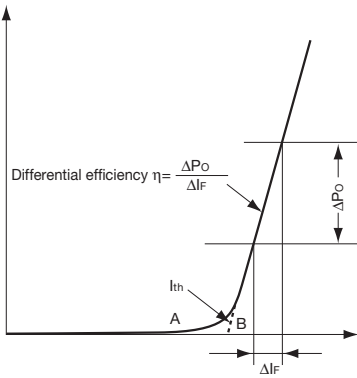

Fig.3 Radiation Characteristics

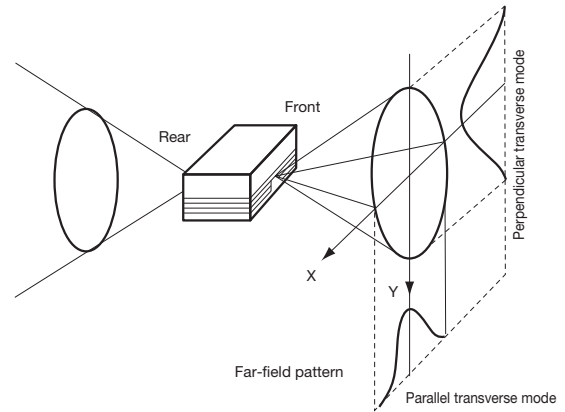

Fig.4 Radiation Characteristics

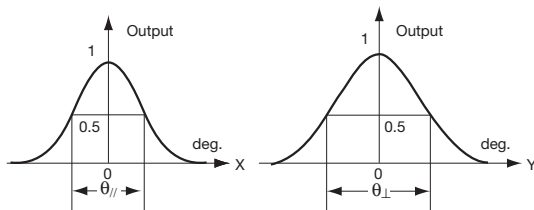

Fig.5 Deviation Angle

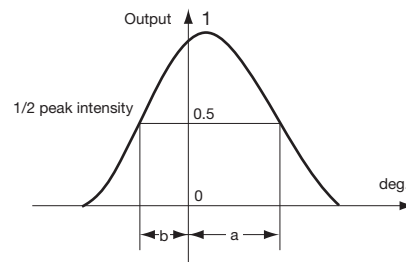

Fig.6 Emission Point Accuracy

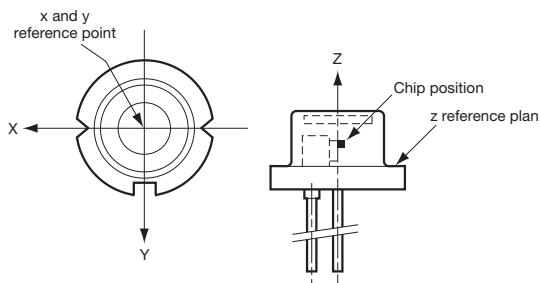
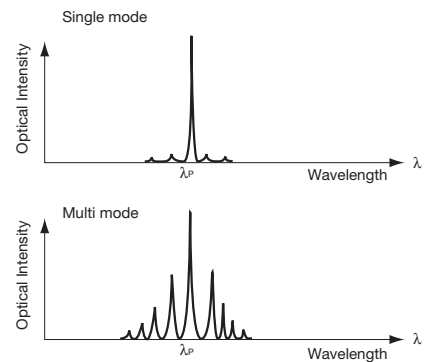
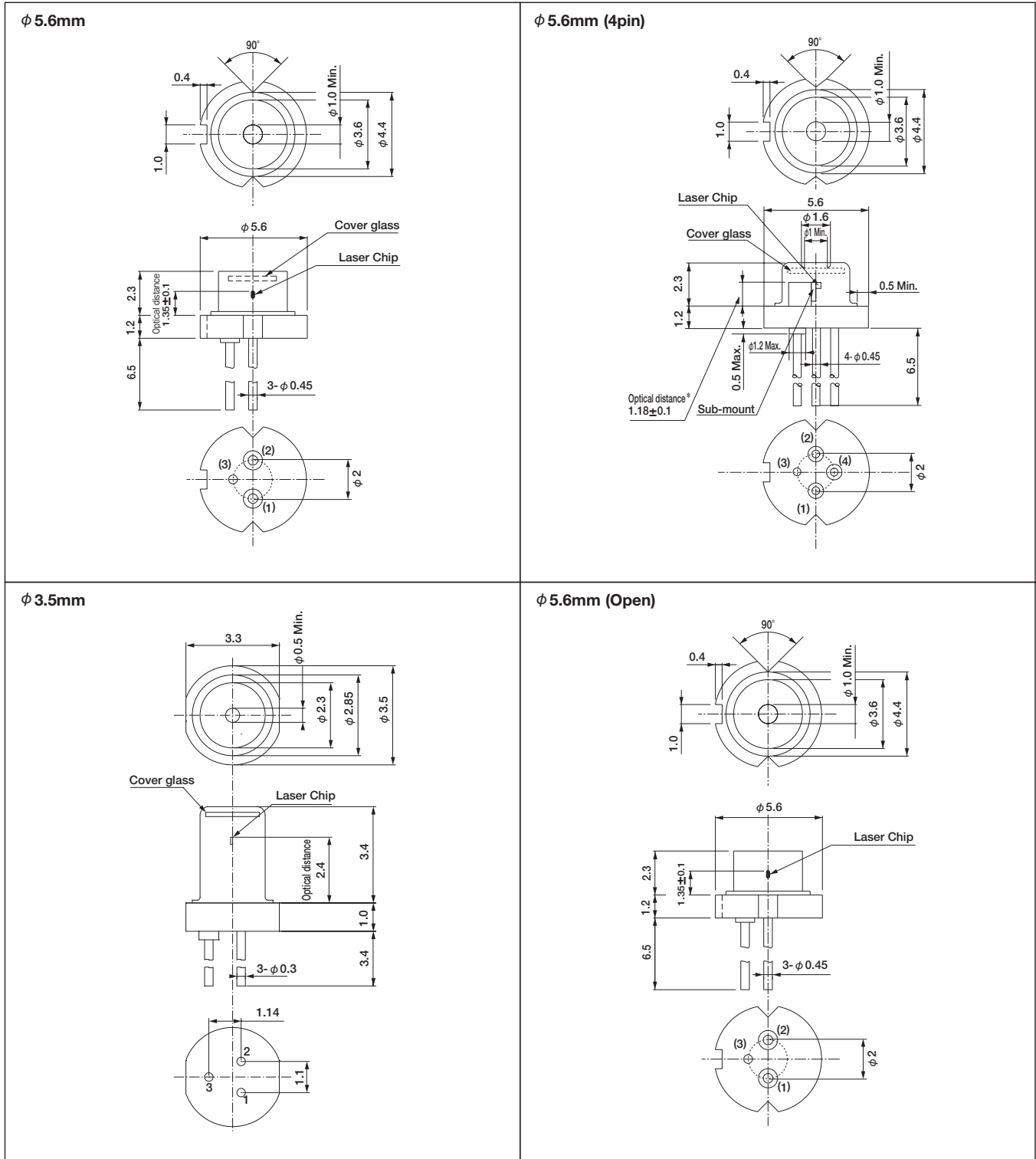

Fig.7 Emission Spectrum



Packaging Specifications

● Dimensions (Unit : mm)



*Please note that differences may exist depending on the part number. Therefore, it is strongly recommended that the customer verify the actual specifications before usage.



Opto Devices

Optical Sensors

CONTENTS

■ Photointerrupter Selection Guide P. E28
■ Transmission type Photointerrupters P. E28
■ Part No. Explanation, Packaging Specifications P. E29
■ Infrared Light Emitting Diodes P. E30
■ Phototransistors P. E31
■ Proximity Sensor P. E31
■ Packages P. E32

Photointerrupter Selection Guide

●Transmission type Photointerrupters

Part No.	Package	Output Type	Standard Characteristics				
			Detection Groove Width(mm)	Slit Width(mm)	Screw stop	Positioning	Remarks
RPI-0125	Surface Mount type	Phototransistor	1.2	0.3			
RPI-0226			2.0	0.3		✓	Wide gap surface mount type
RPI-122	Leaded type		0.8	0.25			
RPI-121			0.8	0.4			
RPI-125			1.2	0.3			
RPI-221			2.3	0.4			
RPI-222			2.0	0.2			
RPI-243			2.0	0.4	✓		
RPI-246			2.0	0.2	✓		
RPI-352			3.0	0.4		✓	
RPI-441C1			4.0	0.5		✓	

●Energysaving Photointerrupters (Eco-friendly type)

Part No.	Package	Output Type	Standard Characteristics				
			Detection Groove Width(mm)	Slit Width(mm)	Remarks		
RPI-0352E	Surface Mount type	Phototransistor	3.0	0.4	Energy saving, High efficiency		
RPI-441C1E	Leaded type	Phototransistor	4.0	0.5	Energy saving, High efficiency		

Transmission type Photointerrupters

Linear Phototransistor Output									
Package	Exterior	Part No.	Standard Characteristics						
			Detection Groove Width (mm)	Slit Width (mm)	I _c (mA)	V _{CE} (V)	I _F (mA)	tr,tf(μs)	
Ultra-Miniature SMD type		RPI-0125	1.2	0.3	0.45 Min. 4.95 Max.	5	20	10	
Miniature SMD type		RPI-0226	2.0	0.3	0.1 Min.	5	5	50	
Ultra-Compact type		RPI-122	0.8	0.25	0.18 Min. 1.08 Max.	0.7	3	10	
		RPI-121	0.8	0.4	0.7 Min.	5	20	10	
		RPI-125	1.2	0.3	0.45 Min. 4.95 Max.	5	20	10	
Compact type		RPI-221	2.3	0.4	0.2 Min.	5	20	10	
		RPI-222	2.0	0.2	0.18 Min. 0.95 Max.	5	10	10	
		RPI-243	2.0	0.4	0.5 Min.	5	20	10	
		RPI-246	2.0	0.2	0.35 Min. 1.2 Max.	5	20	10	
		RPI-352	3.0	0.4	0.2 Min.	5	20	10	
		RPI-441C1	4.0	0.5	0.2 Min.	5	20	10	
Eco-Friendly type		RPI-0352E	3.0	0.4	0.18 Min.	5	10	10	
		RPI-441C1E	4.0	0.5	0.2 Min.	5	10	10	

● Part No. Explanation

● Transmission type

7 characters

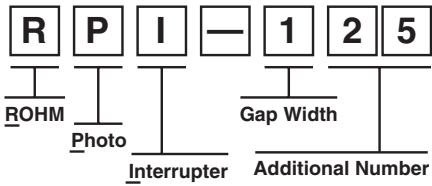

8 characters

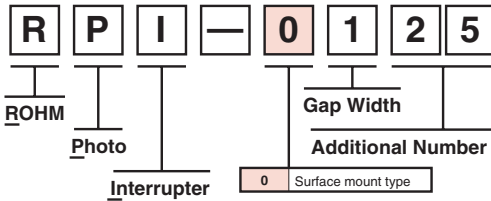

● Packaging Specifications * Examples

Packaging Style	Part No.	Specifications		Quantity Per Unit (pcs)	Basic Ordering Unit (pcs)
		Item Packaging	Case		
Bulk	RPI-243*	Polyethylene bag	Paper box	250/bag	1,000/box
Taping	RPI-0125*	Reel + Aluminum bag	Paper box	750/reel	750/reel

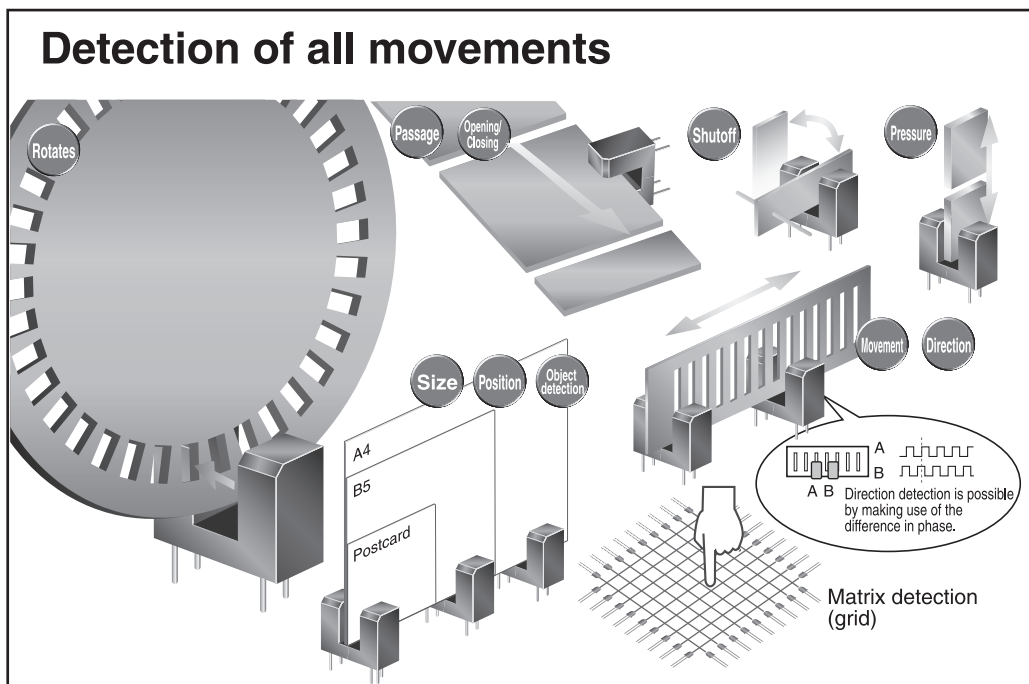

Infrared Light Emitting Diodes

These Ir-LEDs can be used for various remote control applications.

Infrared Light Emitting Diodes 1											
Package	Exterior	Part No.	Features	Absolute Maximum Rating	Standard Characteristics						
				I _F (mA)	I _E (mW/sr)	I _F (mA)	V _F (V)	I _F (mA)	λ _P (nm)	tr,tf (μs)	θ _{1/2} (deg)
φ3 resin		SIR-34ST3F	Optimized for remote controls	100	10.5	50	1.3	100	950	1	27
		SIR-341ST3F	Compact, high power	75	18.1	50	1.3	50	940	1	16
φ5 resin		SIR-56ST3F	Optimized for remote controls	100	15	50	1.3	100	950	1	15
		SIR-563ST3F	High output, Optimized for remote controls	100	21	50	1.34	50	940	1	15
		SIR-568ST3F	High speed LED for optical communications	100	38	50	1.6	50	850	f _c =50MHz	13
Resin side view type		SIM-20ST	General purpose molded type	50	7.5	50	1.3	50	950	1	15
		SIM-22ST	General purpose molded type	50	0.8	10	1.3	50	950	1	30
Surface mount type (Top view)		SIM-030ST	Low Profile (0.9mm)	100	25	100	1.7	100	870	0.1	20
		SIM-040ST	High power	100	40	100	1.7	100	870	0.1	20

The following products are belonging to LEDs.(Refer P.E8)Please ask LED Product group for in query.

Infrared Light Emitting Diodes 2																		
Package (mm)	Part No.	LED Chip	Emitting Color	Absolute Maximum Rating(Ta=25°C)					Electrical and Optical Characteristics(Ta=25°C)									
				Power Dissipation P _D (mW)	Forward Current I _F (mA)	Peak Forward Current I _{FP} (mA)	Reverse Voltage V _R (V)	Operating Temperature Topr (°C)	Storage Temperature Tstg (°C)	Forward Voltage V _F		Reverse Current I _R		Light Wavelength λ _P		Radiant Intensity		
										Typ. (V)	I _F (mA)	Typ. (μA)	V _R (V)	Typ. (nm)	I _F (mA)	Min. (mW/sr)	Typ. (mW/sr)	I _F (mA)
Surface mount type Infrared LEDs 1.0 × 0.6(t=0.2)	☆SML-P15R2T	AlGaAs	Infrared	(40)	(20)	(100) ^{H1}	(5)	(-40 to +85)	(-40 to +100)	(1.6)		(100)		(870)		—	(1.1)	20
Surface mount type Infrared LEDs (Reverse mount available) 3.2 × 1.6(t=1.85)	☆SML-S15R2T			(100)	(50)	(300) ^{H1}	(5)	-40 to +85	-40 to +100	(1.4)		(10)		(840)		(5.6)	(12)	20
Surface mount type Infrared LEDs 2.0 × 1.25(t=0.8)	SML-M13RT			60	100 ^{H1}					20		5		870	20	0.5	1.7	20
Surface mount type Infrared LEDs (Reverse mount available) 3.2 × 1.6(t=1.85)	SML-S13RT				30	300 ^{H1}	5	-40 to +85	-40 to +100	1.4		10		850		1.5	2.5	20
Surface mount type Infrared LEDs 3.0 × 1.5(t=2.2)	SCM-013RT			57	500 ^{H1}									850		0.5	2.0	20

*1:Duty1/10, 1kHz *Mounting Conditions must be carefully Considered () : Reference

☆ : Under Development

●Part No. Explanation

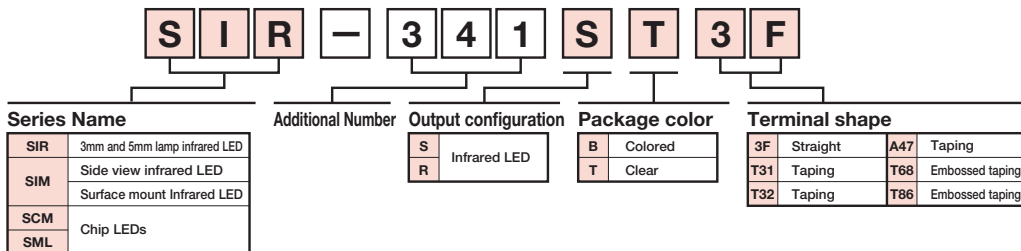

●Packaging Specifications

Packaging Style	Package	Specifications	Quantity Per Unit(pcs)	Basic Ordering Unit(pcs)
Taping	Surface mount type	Embossed taping	—	3,000/reel, 2,000/reel
	All Part No	Radial taping	—	2,000/reel
Bulk	φ3, φ5 types	Item Packaging: polyethylene bag	Case:paper box	φ5mm lamps 1,000/box. φ3mm and side view 2,000/box.
	Side-view			

Phototransistors

ROHM phototransistors have high reliability and large collector currents, side view packages, and $\phi 3$ mm lamp packages are available.

Phototransistors 1												
Package	Exterior	Part No.	Feature	Visible Light Filter	Visible Light Filter		Standard Characteristics					
					V _{CEO} (V)	Pc Max. (mW)	I _{CEO} Max. (μ A)	V _{CE} (V)	I _c (mA)	λ_P (nm)	tr, tf (μ s)	$\theta_{1/2}$ (deg)
$\phi 3$ resin		RPT-34PB3F	Visible light filter	✓	32	150	0.5	10	2.0 Min.	800	10	36
		RPT-37PB3F	Visible light filter, Polarity discrimination	✓	32	150	0.5	10	2.0 Min.	800	10	36
		RPT-38PB3F	Visible light filter	✓	32	150	0.5	10	2.0 Min.	800	10	36
Resin side view type		RPM-20PB	Visible light filter	✓	32	100	0.5	10	0.5 Min.	800	10	14
		RPM-22PB	Visible light filter, Wide viewing angle	✓	32	100	0.5	10	0.48 Min.	800	10	32

The following products are belonging to LEDs.(Refer P.E9)Please ask LED Product group for in query.

Phototransistors 2																		
Package size(mm)	Part No.	LED Chip	Absolute Maximum Ratings(Ta=25°C)						Electrical and Optical Characteristics(Ta=25°C)									
			Collector-Emitter Voltage (V)	Emitter-Collector Voltage (V)	Collector Current (mA)	Collector Power Dissipation (mW)	Operating Temperature Topr (°C)	Storage Temperature Tstg (°C)	Light Current		Dark Current		Sensitivity Wavelength	Collector-emitter Saturation Voltage				
								Min. (mA)	Max. (mA)	V _{CE} (V) / ϵ (Lx)	Max. (μ A)	V _{CE} (V)	λ_P Typ. (nm)	Min. (V)	Typ. (V)	Max. (V)	I _c (mA) / ϵ (Lx)	
 Surface mount photo transistor 2.0×1.25(t=0.8)	SML-H10TB	Si	32	5	30	80	-30 to +85	-30 to +100	2.0	4.0	5/500	0.5	10	800	—	—	0.4	0.1/500
 Surface mount photo transistor (Reverse mount available) 3.4×1.25(t=1.1)	SML-810TB					100			2.3	3.8								
 Surface mount photo transistor 3.0×1.5(t=2.2)	SCM-014TB					100			0.3	3.8								

Proximity Sensor

Proximity Sensor									
Package	Exterior	Part No.	Features	Visible Light Filter	Interface	Absolute Maximum Rating		Standard Characteristics	
						V _{DD} Max. (V)	V _{LED} Max. (V)	PS Sensor Out (Count)	λ_P (nm)
Surface mount		RPR-0521RS	Proximity Sensor and Ambient Light Sensor	Built-in Noise Cancellation Function	I ² C	4.5	7	80	940

●Part No. Explanation

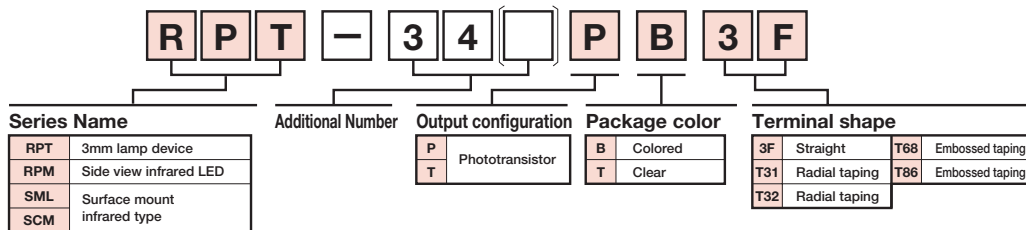

●Packaging Specifications

Packaging Style	Package	Specifications	Quantity Per Unit(pcs)	Basic Ordering Unit(pcs)
Taping	Surface mount type	Embossed taping	—	3,000/reel, 2,000/reel
	$\phi 3$ type Side-view	Radial taping	—	2,000/reel
Bulk	$\phi 3$ type	Item Packaging: polyethylene bag	Case:paper box	500/bag
	Side-view			200/bag

Packages

Dimensions (Unit : mm)

(Photointerrupter)

<p>●RPI-0125</p>	<p>●RPI-0226</p> <p>B area close up (Lead point section)</p>	<p>●RPI-122</p>	<p>●RPI-121</p>
<p>●RPI-125</p>	<p>●RPI-221</p>	<p>●RPI-222</p>	<p>●RPI-243</p>
<p>●RPI-246</p>	<p>●RPI-0352E</p>	<p>●RPI-352</p>	<p>●RPI-441C1, RPI-441C1E</p>

(Infrared Light Emitting Diodes)

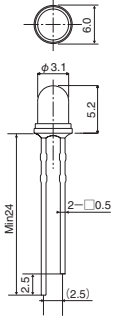
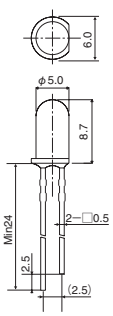
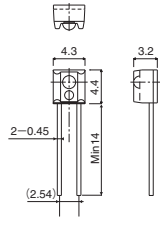
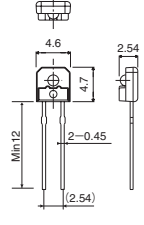
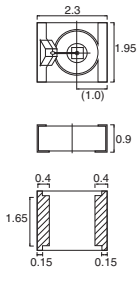
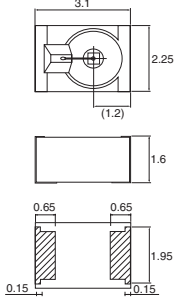
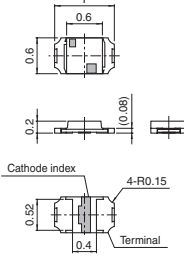
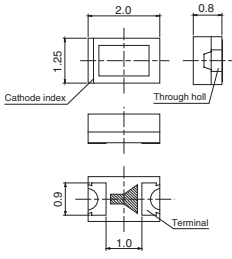
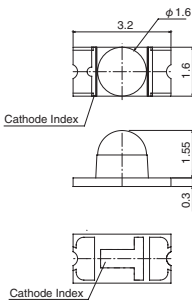
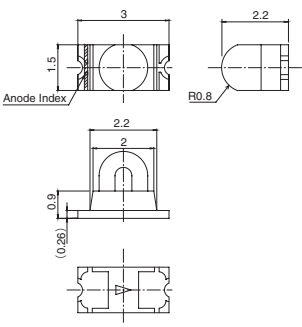
<p>● SIR-34ST3F/341ST3F</p> 	<p>● SIR-56ST3F/563ST3F/568ST3F</p> 	<p>● SIM-20ST</p> 	<p>● SIM-22ST</p> 
<p>● SIM-030ST</p> 	<p>● SIM-040ST</p> 	<p>● SML-P15R2T (PICOLED™)</p> 	<p>● SML-M13RT</p> 
<p>● SML-S13RT, SCM-S15R2T</p> 	<p>● SCM-013RT</p> 		

Packages

●Dimensions (Unit : mm)

〈Phototransistors〉

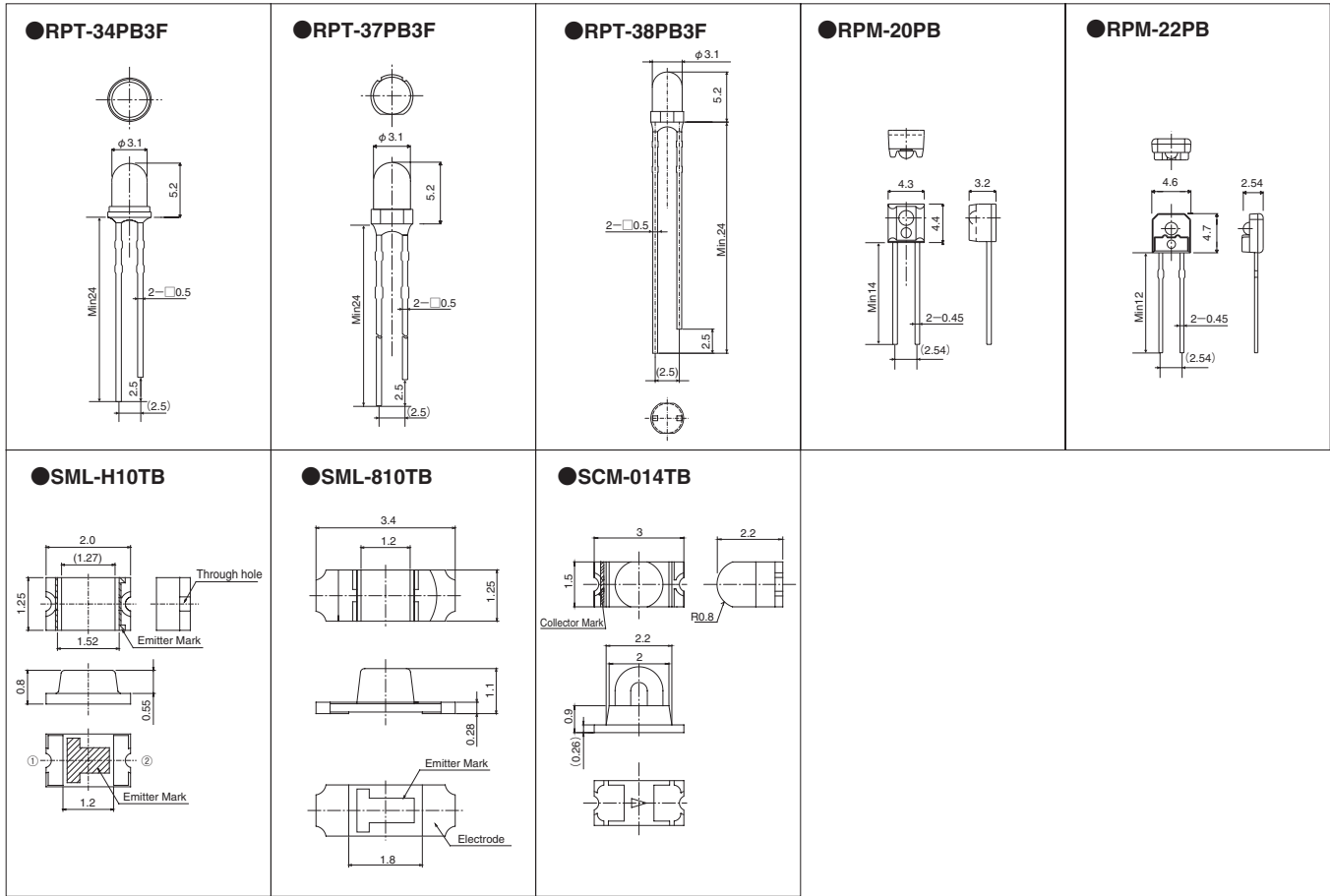

〈Proximity Sensor〉

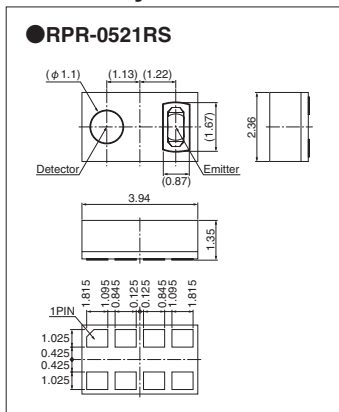



Modules

Power Supply Modules

CONTENTS

■ Power Supply Module Selection Guide	P. F2
■ AC/DC Converters	P. F3
■ DC/DC Converters	P. F4

Power Supply Module Selection Guide

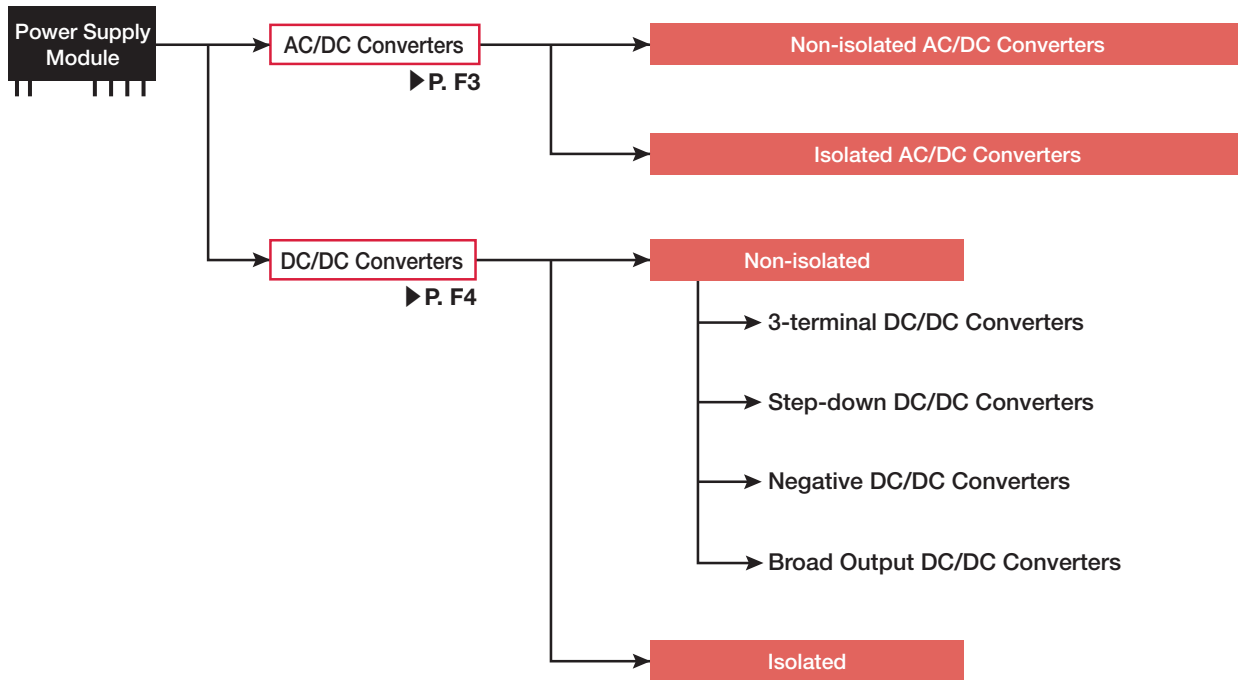

AC/DC Converters

- **No transformer(Non-isolation)**
Few external components required, simplifying the DC power supply.
- **Reduces the size and weight of the power supply unit(Non-isolation type)**
Footprint and weight reduced to 1/4th and 1/30th the value, respectively, compared to transformer-equipped power supplies.
- **Wider input voltage range**
- **For industrial equipment, lighting fixtures, and home electronics**

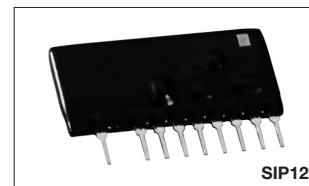

Non-isolated AC/DC Converters

Part No.	Input Voltage(V)	Output Voltage(V)	Output Current(mA)	Dimensions(mm)	Package*	
BP5038A1	113 to 170(AC conversion 80 to 120VAC)	+5	30	18.0×16.8×9.1	SIP6	
BP5063-5			200	28.2×17.9×9.1	SIP10	
BP5033-12		+12	100	28.2×15.5×10.5	SIP10	
BP5037B12			200	28.2×16.8×9.0	SIP10	
BP5039B12			300	35.0×18.0×9.1	SIP12	
BP5067-12			350	34.5×20.0×9.9	SIP12	
BP5037B15		+15	170	28.2×16.8×9.0	SIP10	
BP5039-15			200	35.0×19.5×9.1	SIP12	
BP5067-15			300	35.0×22.0×9.2	SIP12	
BP5039A		113 to 195(AC conversion 80 to 138VAC)	+24	200	35.0×19.5×9.1	SIP12
BP5034D5	+5		100	28.2×15.7×10.0	SIP10	
BP5034D12	+12		100	28.2×15.7×10.0	SIP10	
BP5034D15	+15		80	28.2×15.7×10.0	SIP10	
BP5034D24	+24	50	28.2×15.7×10.0	SIP10		
BP5035A5	-113 to -170(AC conversion 80 to 120VAC)	-5	200	28.2×17.9×9.1	SIP10	
BP5062A5			500	34.5×21.5×10.9	SIP12	
BP5065C		-12	90	26.1×15.2×7.2	SIP9	
BP5061			300	35.0×19.1×9.1	SIP12	
BP5062A			500	34.5×21.5×9.9	SIP12	
BP5068A			800	34.5×21.5×11.3	SIP12	
BP5068-15		-15	800	35.0×22.0×11.5	SIP12	
BP5068A24		-24	600	34.5×21.5×11.3	SIP12	
BP5041A5		226 to 358(AC conversion 160 to 253VAC)	+5	100	32.5×19.3×11.5	SIP10
BP5041A			+12	100	32.5×19.3×11.5	SIP10
BP5048	300			34.5×19.1×9.2	SIP12	
BP5041B15	+15		80	32.5×19.3×11.5	SIP10	
BP5047B15			150	32.5×19.1×10.1	SIP10	
BP5048-15			200	34.5×19.1×9.2	SIP12	
BP5726-15			120 to 239(AC conversion 85 to 170VAC)	427	22.5×27.1×7.8	SIP7
	240 to 390(AC conversion 176 to 276VAC)		800			
BP5047A24	240 to 358(AC conversion 176 to 253VAC)		+24	150	34.5×19.1×9.2	SIP12
BP5048-24	249 to 358(AC conversion 176 to 253VAC)		200	34.5×19.1×9.2	SIP12	
BP5045A5	-113 to -390(AC conversion 80 to 276VAC)	-5	200	28.2×17.9×10.1	SIP10	
BP5045A			200	28.2×17.9×10.1	SIP10	
BP5053-12		-12	200	28.2×17.9×10.1	SIP10	
BP5055-12			250	28.2×21.5×9.9	SIP10	
	-240 to -420(AC conversion 170 to 300VAC)	130				
	-420 to -600(AC conversion 300 to 425VAC)					

Isolated AC/DC Converters

Part No.	Input Voltage(V)	Output Voltage(V)	Output Current(mA)	Dimensions(mm)	Package*
BP5710-1	120 to 162(AC conversion 85 to 115VAC)	+12	350	35.0×24.0×14.9	SIP11
BP5716	113 to 170(AC conversion 80 to 120VAC)	+12	1,000	24.0×25.5×10.1	SIP8
BP5718A12	113 to 195(AC conversion 80 to 138VAC)	+12	1,000	32.5×21.5×9.3	SIP11
BP5722A12	217 to 405(AC conversion 154 to 286VAC)	+12	1,000	32.5×21.5×9.3	SIP11
BP5720-5	113 to 374(AC conversion 80 to 264VAC)	+5.0	500	35.5×20.5×10.0	SIP12
Part No.	Input Voltage(V)	Output Electric Power(W)	Switching Method	Dimensions(mm)	Package*
BP5725	119 to 405(AC conversion 85 to 286VAC)	6	PWM(light load compatible)	22.5×24.0×7.8	SIP7
BP5729	120 to 372(AC conversion 85 to 264VAC)	12/24	quasi-resonance	37.4×24.3×9.3	SIP12
BP5728	113 to 405(AC conversion 80 to 286VAC)	6/12	PWM(light load compatible)	18.8×19.5×9.9	SIP6
BP5717	113 to 195(AC conversion 80 to 138VAC)	18	quasi-resonance	37.4×24.3×9.3	SIP12

* Original power supply module package used

Typical Applications

Typical Operating Circuit

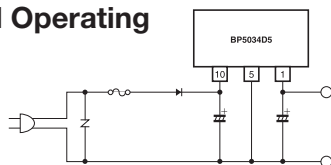

Typical Supply for Vacuum Cleaner

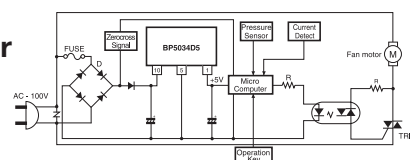

DC/DC Converters

- **High efficiency**
High energy conversion factor(85 to 93%)contributes to compact, power-saving supplies.
- **Few external parts**
Because the external part is only two condensers, it can compose a powersupply circuit easily.
- **Internal output switch**
Enables full use of power saving feature.
- **Wider input voltage range**
Can operate with unregulated mains.(BP5220A/5221A : 8 to 38V)
- **Universal**
Wide applicability(i.e. output switches, protection circuits, output voltage regulators)
- **Small footprint**
SIP package requires less mounting space.(Board footprint: 65mm²)

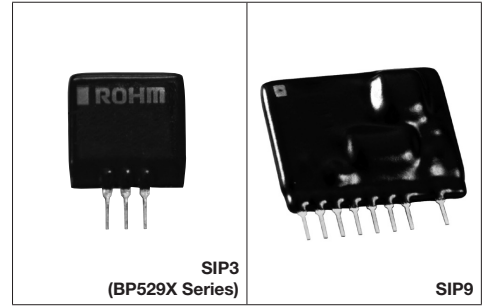

*Because there is a product which doesn't have some of these features and characteristic, too, confirm details with each specification.

3-terminal DC/DC Converters(Non-isolated)

Part No.	Input Voltage(V)	Output Voltage(V)	Output Current (mA)	Output Voltage Accuracy(%)	Dimensions(mm)	Package*
BP5293-33	7 to 26	+3.3	1,000	±3.0	17.0×17.8×7.2	SIP3
BP5293-50	7 to 26	+5.0	1,000	±2.0	17.0×17.8×7.2	SIP3
BP5293-12	17 to 26	+12.0	1,000	±5.0	17.0×17.8×7.2	SIP3

* Non need external parts.(Incorporates input and output Capacitor and Inductor) • Pin compatible with Three-terminal LDO.

Step-down DC/DC Converters(Non-isolated)

Part No.	Input Voltage(V)	Output Voltage(V)	Output Current(mA)	Dimensions(mm)	Package*
BP5224-33	7 to 18	+3.3	300	17.8×18.1×9.7	SIP6
BP5223	8 to 18	+5	150	17.0×16.8×10.4	SIP5
BP5220A	8 to 38	+5	1,000	28.0×19.5×12.0	SIP9
BP5221A	8 to 38	+5	500	28.0×19.5×12.0	SIP9
BP5222A	15 to 38	+12	500	28.0×19.5×12.0	SIP9
BP5226-18	20 to 46	+18	500	34.0×17.4×8.1	SIP12

Negative DC/DC Converters(Non-isolated)

Part No.	Input Voltage(V)	Output Voltage(V)	Output Current(mA)	Dimensions(mm)	Package*
BP5122	8 to 20	-12	100	26.7×19.5×12.7	SIP9

Broad Output DC/DC Converters(Non-isolated)

Part No.	Input Voltage(V)	Output Voltage(V)	Output Current(mA)	Output(ch)	Dimensions(mm)	Package*
BP5811	19 to 21	0 to 19	300	1	27.7×16.0×7.6	SIP9

* The output voltage can be controlled with the PWM signal or the DC signal. This product is best to control a motor and so on.

Isolated DC/DC Converters

Part No.	Input Voltage(V)	Output Voltage(V)	Output Current(mA)	Isolation Voltage(V)	Dimensions(mm)	Package*
BP5512A	4.5 to 6.5	+5	200	AC2300	28.2×21.4×17.2	SIP7
BP5324A	4.5 to 5.5	+12	250	AC500	38.5×27.0×13.6	SIP12
BP5510-24	10.8 to 13.2	+24	200	AC500	32.6×24.2×13.6	SIP11

* Original power supply module package used

■ Typical Applications(Basic)

● Step-down DC/DC Converters (Non-isolated)

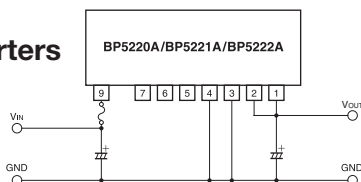

● Isolated DC/DC Converters

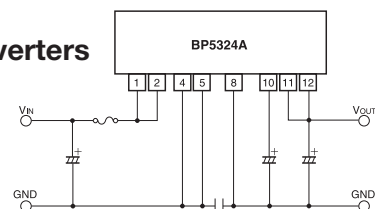



Modules

Wireless Modules

CONTENTS

- ROHM Wireless Modules Technology P. F6
- Wi-SUN Communication Modules
(Specified Low Power Radio Modules) P. F6
- Wireless LAN Modules P. F6
- Bluetooth® Modules (LAPIS Semiconductor products) P. F7
- IEEE802.15.4 Communication Module
(LAPIS Semiconductor products) P. F7
- EnOcean® Communication Modules P. F8

ROHM Wireless Modules Technology

Wireless Communication

The correspondence of various wireless specifications

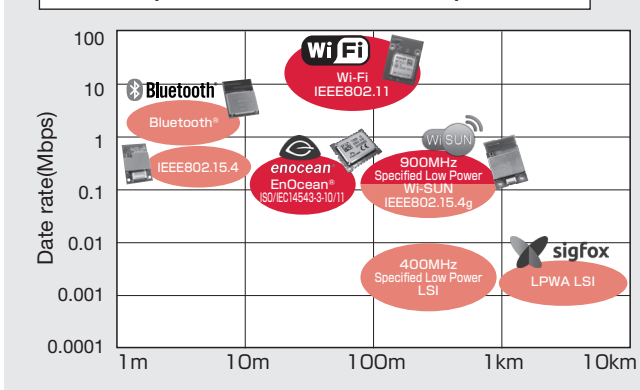

• ROHM group is developing Wireless Communication devices in a broad range of fields.

Wi-SUN Communication Modules (Specified Low Power Radio Modules)



- 920MHz specified low-power wireless module
- Excellent receiver sensitivity
- Built-in antenna eliminates the need for high-frequency designs
- Transmitting power pre-adjusted
- MAC address included
- Japan radio law certified

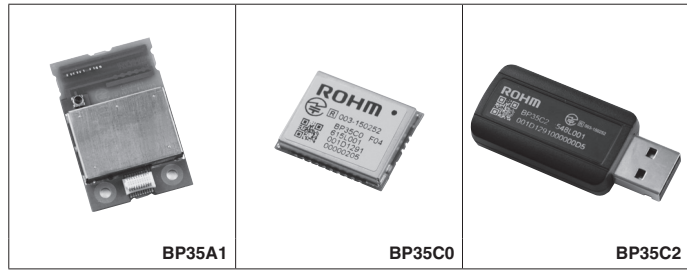

Wi-SUN Communication Modules (Specified Low Power Radio Modules)

Part No.	Supply Voltage (V)	Operating Temperature (°C)	Host I/F	Terminal Standards	Onboard System LSI	Dimensions (mm)	Package
BP35A1	2.7 to 3.6 (Single power)	-20 to +80	UART	Wi-SUN	ML7396B (LAPIS Semiconductor)	22.0×33.5×4.0	Connector joint type 0.5mm pitch, 20pin
New BP35C0	2.6 to 3.6 (Single power)	-30 to +85	UART	Wi-SUN	ML7416N (LAPIS Semiconductor)	15.0×19.0×3.0	SMD 1.27mm pitch, 28pin
New BP35C2	5.0 (Single power)	-20 to +50	USB	Wi-SUN	ML7416N (LAPIS Semiconductor)	21.4×49.7×8.5	USB Dongle

Wireless LAN Modules

- IEEE802.11b/g/n compliant Wireless LAN Module
- Built-in baseband IC that made in ROHM
- Transmission power is already adjusted
- Japan radio law certified

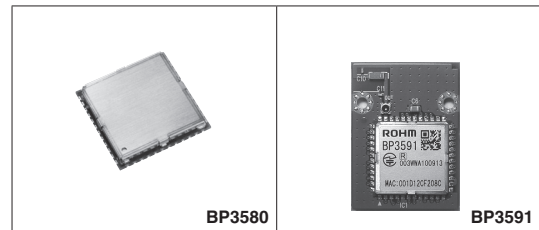

Wireless LAN Modules

Part No.	Supply Voltage (V)	Operating Temperature (°C)	Host I/F	Terminal Standards	Onboard System LSI	Dimensions (mm)	Package*
BP3580	3.1 to 3.5 (Single power)	-40 to +85	USB/SDIO/UART	•IEEE802.11b/g/n	BU1805GU	17.0×17.0×2.3	Surface mount type End face through hole 1.27mm pitch, 48pin
BP3591	3.1 to 3.5 (Single power)	-40 to +85	USB/SDIO/UART	•IEEE802.11b/g/n •BP3580 and chip-antenna into 1 module	BU1805GU	24.0×33.1×4.7	Connector joint type 0.5mm pitch, 34pin
BP3595	3.1 to 3.5 (Single power)	-40 to +85	USB/SDIO/UART	•IEEE802.11b/g/n •The small size type of BP3591	BU1805GU	15.3×27.6×2.6	Connector joint type 0.4mm pitch, 30pin
BP3599	3.1 to 3.5 (Single power)	-40 to +85	USB/SDIO/UART	•IEEE802.11b/g/n •Type with flash memory mounted on BP3591 •Firmware is written in a flash memory	BU1805GU	24.0×33.1×4.7	Connector joint type 0.5mm pitch, 34pin
BP359B	3.1 to 3.5 (Single power)	-40 to +70	USB/UART/SPI	•IEEE802.11b/g/n •Type with MCU and flash memory mounted on BP3591 •Firmware is written in a flash memory	BU1805GU	24.0×33.1×4.7	Connector joint type 0.5mm pitch, 34pin

*Original ROHM package used.

Bluetooth® Modules Bluetooth®

- Bluetooth low energy single mode module
- Compliant to Bluetooth Core Spec. v4.1(MK71251 series)
- Low power consumption and the best solution for the instruments using coin type/button battery
TX : 6.7mA, RX : 6.2mA (MK71251 series)
- LAPIS Semiconductor's RF LSI mounted
- RF characteristic adjusted before shipment
- Built-in pattern antenna and certified TELEC, FCC, IC, CE (MK71251series/MK71050-03)



Bluetooth® Low Energy Modules (LAPIS Semiconductor products)									
Part No.	Supply Voltage(V)	Operating Temperature(°C)	Host I/F	Supported Standard	Certification	Module Specification	LSI	Dimension (mm)	Package
MK71050-03	1.8 to 3.6	-20 to +70	(BACI*1) SPI (HCI*2) UART	Bluetooth® Core spec. v4.0 (Single mode)	Bluetooth® certification: QDID:66491(End Product), Radio law certification TELEC/FCC/IC/CE	Role:Master/Slave Connectable device(s) : 1 device	ML7105C-001 (Lapis Semiconductor)	10.7×13.6×1.78	SMT LGA52
MK71251-01	2.0 to 3.6	-20 to +75	(BACI*1) SPI (HCI*2) UART	Bluetooth® Core spec. v4.1 (Single mode)	Bluetooth® certification: QDID:77987(End Product), Radio law certification TELEC/FCC/IC/CE	Role:Master/Slave Connectable device(s) : 2 devices	ML7125-001 (Lapis Semiconductor)	8.0×11.0×2.00	SMT LGA33
MK71251-02	2.0 to 3.6	-20 to +75	UART	Bluetooth® Core spec. v4.1 (Single mode)	Bluetooth® certification: QDID:77987(End Product), Radio law certification: TELEC/FCC/IC/CE	Role: Slave only Connectable device(s) : 1 device Application : Blank	ML7125-002 (Lapis Semiconductor)	8.0×11.0×2.00	SMT LGA33
MK71251-02A						Role: Slave only Connectable device(s) : 1 device Applicatoin : Serial communication			
MK71251-02B						Role: Slave only Connectable device(s) : 1 device Application : Beacon			

*1 : BACI(Bluetooth® Application Controller Interface);Lapis Semiconductor proprietary host interface *2 : HCI(Host Control Interface);Bluetooth® standard interface.
*User need a confirmation and an agreement on an application and usage environment before using MK71251 series modules.
*Bluetooth® is a registered trademark of Bluetooth SIG.

IEEE802.15.4 Communication Module

- IEEE802.15.4 compliant wireless communication module
- IEEE802.15.4-2003PHY/MAC integrated (MAC is not full function)
- LAPIS Semiconductor's RF LSI mounted
- RF characteristic adjusted before shipment
- Built-in antenna and certified TELEC

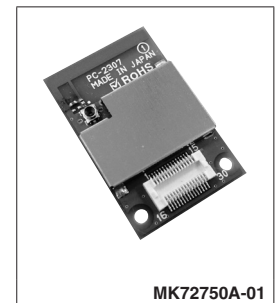

IEEE802.15.4 Communication Module (LAPIS Semiconductor products)									
Part No.	Supply Voltage(V)	Operating Temperature(°C)	Host I/F	Supported Standard	Certification	Module Specification	LSI	Dimension (mm)	Package
MK72750A-01	1.8 to 3.6	-40 to +85	UART	IEEE802.15.4	Radio law certification: TELEC	IEEE802.15.4-2003 PHY/MAC (Not full MAC function)	ML7275 (Lapis Semiconductor)	20.0×31.0×2.7	30pin Connector

EnOcean® Communication Modules

EnOcean® products are based on energy harvesting battery-less/wireless telecommunication technology.











ROHM has become a promoter of EnOcean alliance which promote next generation radio telecommunication standard since 2012, and we contribute to the expansion of EnOcean® communication method.

*EnOcean® is a registered trademark of EnOcean GmbH.

■ Feature

- EnOcean® Wireless Standard(ISO/IEC14543-3-10/11)
- Built-in antenna eliminates the need for high-frequency designs
- Japan radio law certified

*This product(928MHz frequency band) is permitted as "specified low-power radio station" in Japanese radio law.

EnOcean® Communication Modules/Devices											
Frequency Band	Use Target Area	Products									
											
		Energy converter for motion energy harvesting (for the switch module)	Transmitter module (for switch module)	Push button multi-channel switch module	Energy harvesting wireless transceiver module	Programmable transceiver module	Energy harvesting magnet contact module	Energy harvesting temperature sensor module	Humidity sensor module	Receiver USB module	Development kit
928MHz	Japan	ECO 200	PTM 430J	PTM 210J	STM 400J	TCM 410J	STM 429J	STM 431J	HSM 100	USB 400J	EDK 400J*
868MHz	Europe/China	ECO 200	PTM 330	PTM 210	STM 300	TCM 310	STM 320	STM 331	HSM 100	USB 300	EDK 350

*Contents: PTM 210J (Switch Module) / USB 400J (USB Dongle) / PTM 430J (Circuit Board for Switch Module) / ECO 200 (Electromagnetic Induction Generator for Switch Module) / STM 431J (Temperature Sensor Module) / STM 400J (Energy Harvesting Wireless Module) / EOP 350 (Programming Board : it's for rewriting of STM 431J, STM 400J) / USB Cable ... Connection cable of EOP 350 and PC
 ●STM 400J in EDK 400J is mounted on the exclusive Substrate to connect to EOP 350

- Please choose your region products by frequency band.
- Please contact a ROHM sales representative for purchase and inquiry.
- Please refer to our EnOcean® introduction page(<http://www.rohm.com/web/global/enoclean>) for detail.



Modules

Thermal Printheads

CONTENTS

■ Introduction of ROHM Thermal Printheads	... P. F10
■ Part No. Configuration P. F11
■ For Facsimiles : A series P. F12
■ For Mobile Printers series P. F12
■ For Gaming Equipment, ATMs : CF/CA, CG/LE series P. F13
■ For POS Terminals : DF/DA, DE/KE series	... P. F14
■ For Ticket, Barcode Label Printers : DC92/DC72, AE series P. F15
■ For Packaging High-speed Printers : AH series P. F16

Introduction of ROHM Thermal Printheads

Propose various applications from ROHM wide line-up

1. New Thermal Printhead for saving energy and high speed printing.

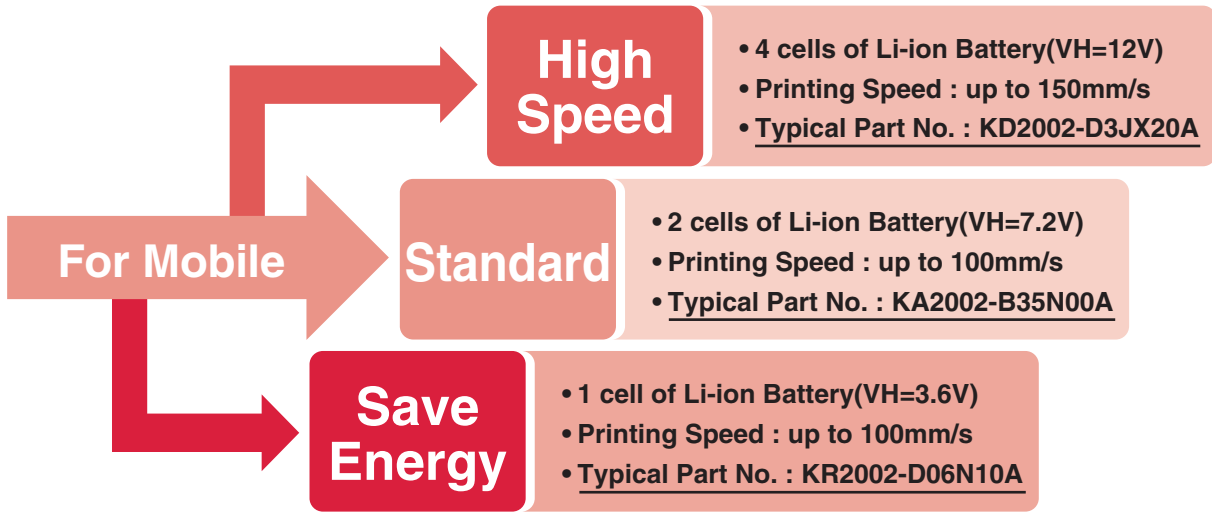

From traditional 7.2V drive, the customer need diversification of applications. ROHM is developing in order to response these requests.

2. ROHM wide line-up

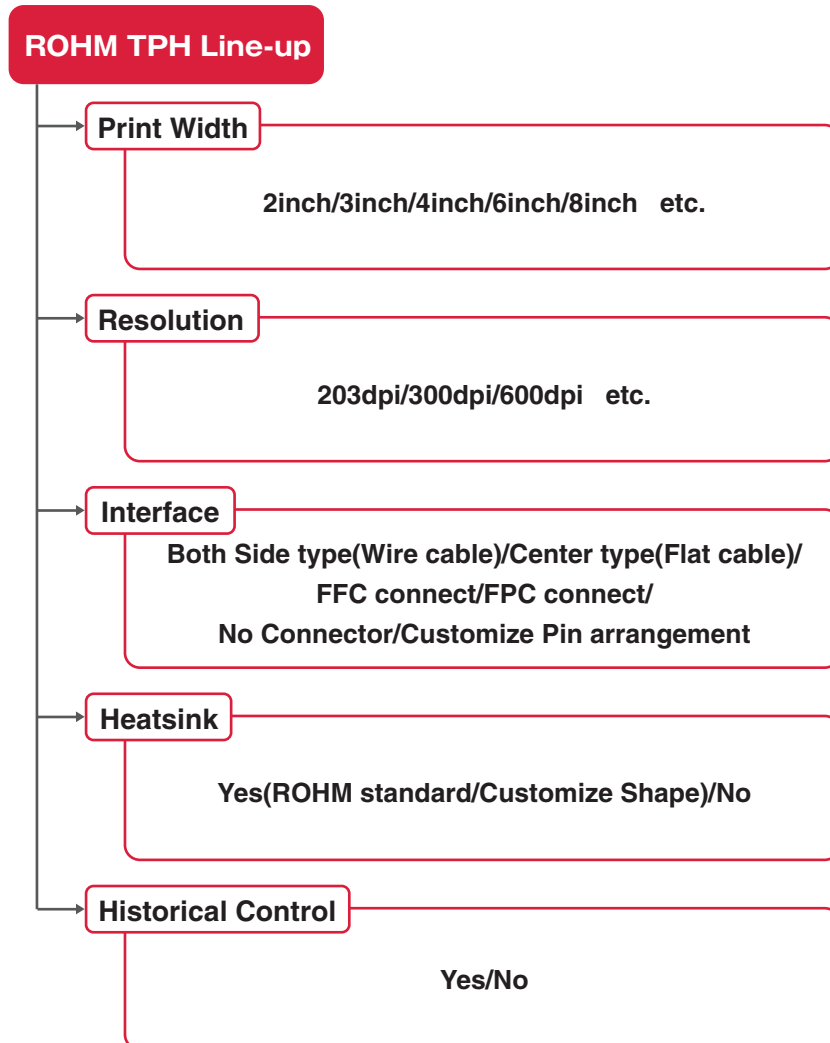

We have various line-up to response the customer requests. Please contact a ROHM sales representative for further details when there is no product on our line-up.



Part No. Configuration

Totally 13 digit

K D 2 0 0 4 - D 1 F W 0 0 A

**Structure of TPH
Ex.)**

KA	Thick-film, All glaze
KD	Thick-film, Partial glaze
AE	Thin-film, Partial glaze
etc.	

**Resolution
Ex.)**

10	100dpi
15	150dpi
18	180dpi
20	203dpi
30	300dpi
36	360dpi
60	600dpi

**Print Width
Ex.)**

01	1inch
02	2inch
03	3inch
04	4inch
05	5inch
06	6inch
08	8inch
10	10inch

**Option
Ex.)**

DA	Both side type with Heatsink
D1	Both side type without Heatsink
etc.	

Discrimination Number

Totally 11 digit

K D 2 0 0 4 - D F 1 0 A

**Structure of TPH
Ex.)**

KA	Thick-film, All glaze
KD	Thick-film, Partial glaze
AE	Thin-film, Partial glaze
etc.	

**Resolution
Ex.)**

10	100dpi
15	150dpi
18	180dpi
20	203dpi
30	300dpi
36	360dpi
60	600dpi

**Print Width
Ex.)**

01	1inch
02	2inch
03	3inch
04	4inch
05	5inch
06	6inch
08	8inch
10	10inch

**Option
Ex.)**

DF	Both side type with Heatsink
DG	Center type with Heatsink
etc.	

Discrimination Number

For Facsimiles : A series

A series

■ Features

In-house IC is mounted on ROHM printheads for A4 facsimiles, contributing to a reduction in the size and weight of printers. It enjoys wide use due to their high productivity, basic structure and reliable performance.

■ Applications

Facsimiles of all types, from personal to business. Also ideal for ECGs and other medical imaging equipment due to particle-free printing.

For Facsimiles : A series

Part No.	Resolutions (dpi)	Print Width (mm)	Number of dot (dots)	Resistance Tolerance (Ω)	Platen Diameter Max. (mm)	Print Speed (mm/s)	Supply Voltage (VH)	Logic Voltage (V _{cc})	Heat Sink	Interface
KA2008-AF10A	203	216	1,728	3,000	20.0	6.25 to 12.5	24	3.13 to 5.25	Yes	9pin x 2 Both-side type (Wire cable)

For Mobile Printers series

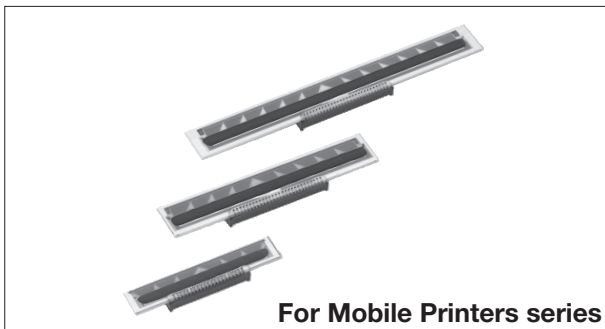
For Mobile Printers series

■ Features

3.6V Li-ion battery driving model and 150mm/s high speed printing model are added to line-up.

ROHM develops the products in order to respond to the diversification of product.

■ Applications

Ideal for mobile printers, with low voltage and current capacity limitations, and EFT-POS terminals, receipt printers and compact label printers, where small size and low energy consumption are important requirements.

For Mobile Printers series

Part No.	Resolutions (dpi)	Print Width (mm)	Number of dot (dots)	Resistance Tolerance (Ω)	Platen Diameter Max. (mm)	Print Speed (mm/s)	Supply Voltage (VH)	Logic Voltage (V _{cc})	Heat Sink	Interface			
KR2002-D06N10A	203	48	384	80	8.0	100	3.6	2.7 to 5.25	—	21 pin Non connector (Pre-soldering)			
KA2002-FB20A				176							14.0	7.2	21 pin Center type (Flat cable)
KA2002-B35N00A													
KA2003-B35N00A		48	384										
KA2002-BE13A		72	576										
KA2003-BE51A		104	832	28pin Center type (Flat cable)									
KA2004-BE51A		104	832										
KA2004-D35N90A	300	48.8	576	8.0	75	21 pin Non connector (Pre-soldering)							
KA2002-D35N20A	203	48	384	210	14.0	100	12.0	—	21 pin Center type (Flat cable)				
KA2003-D35N20A		72	576										
KD2002-D3JX20A		48	384										
KD2003-D3JX20A		72	576										
KD2002-D5JX20A		56	448		150	28pin Center type (Flat cable)							
KD2003-D5JX20A		80	640										
KD2004-D5JX20A		104	832										
KD2004-D5JX20A		104	832										

We can also develop a thermal printhead per customized specifications. Please contact a ROHM sales representative for further details.

For Gaming Equipment, ATMs : CF/CA, CG/LE series



CF/CA series

■ Features

Adopting the most suitable structures of the heat elements such as CF/CA series for 100mm/s high speed printing, CG series for 150mm/s make the high quality printings and energy-savings possible. Plus, those thermal print heads are able to cover various controls by adopting the high-frequency clock.

■ Applications

High versatility makes these products ideal for POS terminals, ATMs, gaming, lottery printers, and the like.



CG/LE series

CF/CA series

Part No.	Resolutions (dpi)	Print Width (mm)	Number of dot (dots)	Resistance Tolerance (Ω)	Platen Diameter Max. (mm)	Print Speed (mm/s)	Supply Voltage (VH)	Logic Voltage (V _{DD})	Heat Sink	Interface
KD2002-CAFW00A	203	54	432	800	14.0	150	24	3.13 to 5.25	Yes	7pin×2, Both-side type (Wire cable)
KD2003-CAFW00A		72	576						Yes	9pin×2, Both-side type (Wire cable)
KD2004-CAFW00A		108	864						Yes	
New KD2004-C1GW00A		108	864						—	
New KD2004-CAGW00A		108	864						Yes	
KD2008-CF10A		216	1,728						1,000	20.0
KD2008-CF16A	216	1,728	800	125	Yes					
KD3008-CF10A	300	219.5	2,592	1,250	100	Yes				

CG/LE series

Part No.	Resolutions (dpi)	Print Width (mm)	Number of dot (dots)	Resistance Tolerance (Ω)	Platen Diameter Max. (mm)	Print Speed (mm/s)	Supply Voltage (VH)	Logic Voltage (V _{DD})	Heat Sink	Interface
KD2002-CG11A	203	54	432	800	20.0	150	24	3.13 to 5.25	Yes	28pin Center type (Flat cable)
KD2003-CG11A		72	576						Yes	
New KD2003-CG22A		72	576		Yes					
New KD2003-CE22A		72	576		—					
KD2004-CG11A		108	864		Yes					
KD2008-CG50A		216	1,728		20.0				125	
KD3003-LEGW00A	300	73.2	864	1,000		Yes				

We can also develop a thermal printhead per customized specifications. Please contact a ROHM sales representative for further details.

For POS Terminals : DF/DA, DE/KE series

DF/DA series

DE/KE series

■ Features

The original heat element structure enables dark printing from the get go with minimal smearing at the end for optimum print quality, even at high 100 to 250mm/s printing speeds.

■ Applications

Ideal for POS and ECR printers that support high-speed printing (6 to 10ips) and compact label printers.

DF/DA series										
Part No.	Resolutions (dpi)	Print Width (mm)	Number of dot (dots)	Resistance Tolerance (Ω)	Platen Diameter Max. (mm)	Print Speed (mm/s)	Supply Voltage (VH)	Logic Voltage (Vcc)	Heat Sink	Interface
KD2002-DAFW00A	203	56	448	650	20.0	250	24	3.13 to 5.25	Yes	15pin×2, Both-side type (Wire cable)
KD2003-DAFW00A		80	640						Yes	
KD2004-DAFW00A		104	832						Yes	
New KD2004-D1GW00A		104	832						—	
New KD2004-DAGW00A	300	54.2	640	1,000	18.0	100	24	3.13 to 5.25	Yes	15pin×3, 3 points connector (Wire cable)
KD3002-DF11A		81.3	960						Yes	
KD3003-DF11A		108.4	1,280						Yes	
New KD3004-DF11A		108.4	1,280						—	
New KD3004-K1GW00A	300	216.8	2,560	660	25.0	100	24	4.75 to 5.25	Yes	15pin×3, 3 points connector (Wire cable)
KD3008-DF54A		216.8	2,560						660	
DE/KE series										
Part No.	Resolutions (dpi)	Print Width (mm)	Number of dot (dots)	Resistance Tolerance (Ω)	Platen Diameter Max. (mm)	Print Speed (mm/s)	Supply Voltage (VH)	Logic Voltage (Vcc)	Heat Sink	Interface
KD2002-DEFW00A	203	56	448	650	20.0	250	24	3.13 to 5.25	Yes	28pin Center type (Flat cable)
New KD2003-D0FW00A									—	28pin Non connector (Pre-soldering)
New KD2003-D5FW00A									—	28pin Center type (Flat cable)
New KD2003-D5GW00A									—	
KD2003-DEFW00A									Yes	
New KD2003-DEGW00A									Yes	28pin Non connector (Pre-soldering)
New KD2003-F0FW00A		—								
New KD2003-F5FW00A		—	28pin Center type (Flat cable)							
New KD2003-F0GW00A		—	28pin Non connector (Pre-soldering)							
New KD2003-F5GW00A		—								
KD2004-DEFW00A		Yes	28pin Center type (Flat cable)							
New KD2004-D0GW00A		—	28pin Non connector (Pre-soldering)							
KD3003-KEFW00A	Yes	28pin Center type (Flat cable)								

We can also develop a thermal printhead per customized specifications. Please contact a ROHM sales representative for further details.

For Ticket, Barcode Label Printers : DC92/DC72, AE series

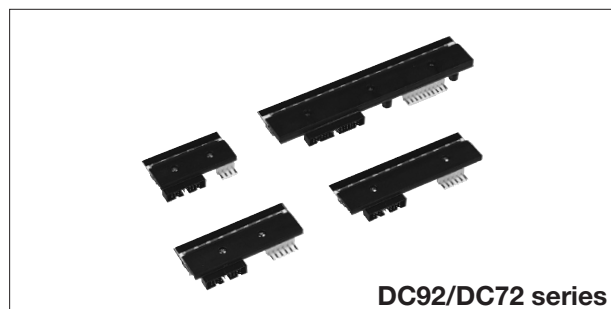

■ Features

ROHM's high-current thermal printheads, featuring a heat element structure compatible with high-speed printing along with a durable protective coating, enable high-speed printing with superior energy savings, providing superior reliability in industrial equipment. The heat history controls are equipped with DC72 which is ROHM's original and covers high speed printings of 12ips.

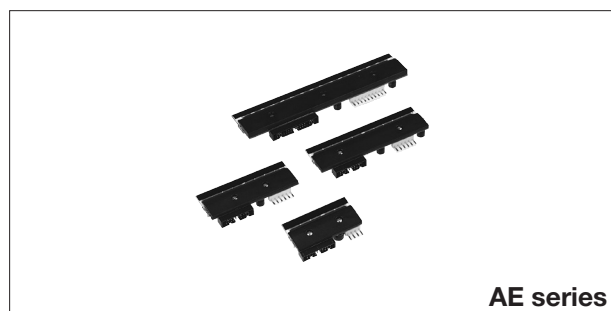

■ Applications

Ideal for bar-code printers or label printers at factory lines or distribution centers where 24-hour operation or continuous printing are required.

DC92 series											
Part No.	Resolutions (dpi)	Print Width (mm)	Number of dot (dots)	Resistance Tolerance (Ω)	Platen Diameter Max. (mm)	Print Speed (mm/s)	Supply Voltage (VH)	Logic Voltage (V _{cc})	Heat Sink	Interface	Historical Control
KD2002-DC92A	203	56	448	550	20.0	100 to 150	24	4.75 to 5.25	Yes	20pin connector, 4pin power connector (Wire cable)	—
KD2003-DC92A		80	640							20pin connector, 6pin power connector (Wire cable)	
KD2004-DC92A		104	832							34pin connector, 10pin power connector (Wire cable)	
KD2006-DC92A	168	1,344	650	20pin connector, 4pin power connector (Wire cable)							
KD3002-DC92A	300	54.2	640	1,250		50 to 100				20pin connector, 6pin power connector (Wire cable)	
KD3003-DC92A		81.3	960							34pin connector, 10pin power connector (Wire cable)	
KD3004-DC92A		108.4	1,280		20pin connector, 4pin power connector (Wire cable)						
KD3006-DC92A		162.6	1,920		650		20pin connector, 6pin power connector (Wire cable)				
DC72 series											
Part No.	Resolutions (dpi)	Print Width (mm)	Number of dot (dots)	Resistance Tolerance (Ω)	Platen Diameter Max. (mm)	Print Speed (mm/s)	Supply Voltage (VH)	Logic Voltage (V _{cc})	Heat Sink	Interface	Historical Control
KD2002-DC72A	203	56	448	550	20.0	100 to 250	24	4.75 to 5.25	Yes	20pin connector 4pin power connector (Wire cable)	Yes
KD2003-DC72A		80	640							20pin connector 6pin power connector (Wire cable)	
KD2004-DC72A		104	832							34pin connector 10pin power connector (Wire cable)	
KD2006-DC72A	168	1,344	650	20pin connector 4pin power connector (Wire cable)							
KD3002-DC72A	300	54.2	640	1,250		100 to 200				20pin connector 6pin power connector (Wire cable)	
KD3003-DC72A		81.3	960							34pin connector 10pin power connector (Wire cable)	
KD3004-DC72A		108.4	1,280		20pin connector 4pin power connector (Wire cable)						
KD3006-DC72A		162.6	1,920		1,000		20pin connector 6pin power connector (Wire cable)				
AE series											
Part No.	Resolutions (dpi)	Print Width (mm)	Number of dot (dots)	Resistance Tolerance (Ω)	Platen Diameter Max. (mm)	Print Speed (mm/s)	Supply Voltage (VH)	Logic Voltage (V _{cc})	Heat Sink	Interface	Historical Control
AE2004-DC50A	203	112	896	800	20.0	150	24	4.75 to 5.25	Yes	26pin connector	—
AE3004-DC50A	300	108.4	1,280	1,250		100				6pin power connector (Wire cable)	

We can also develop a thermal printhead per customized specifications. Please contact a ROHM sales representative for further details.

For Packaging High-speed Printers : AH series

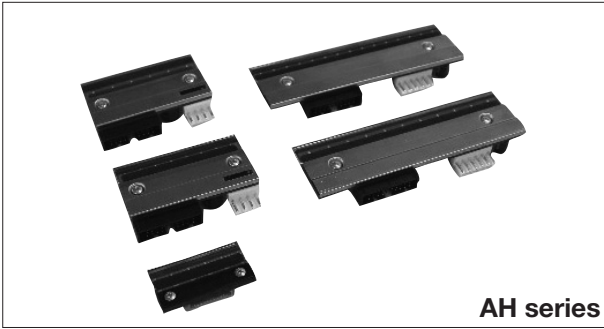
AH series

■ Features

These thermal heads feature a near-edge structure based on the high-speed, high-quality, reliable step-free SE, SF series, enabling straight path for hard media or high speed printing.

■ Applications

Ideal for packaging printers requiring high reliability.

For Packaging High-speed Printers : AH series													
Part No.	Resolutions (dpi)	Print Width (mm)	Number of dot (dots)	Resistance Tolerance (Ω)	Platen Diameter Max. (mm)	Print Speed (mm/s)	Supply Voltage (VH)	Logic Voltage (V _{cc})	Heat Sink	Interface	Historical Control		
AH2001-DK50A	203	40	320	850	∞	62.5	12	4.75 to 5.25	Yes	15pin Center type (Wire cable)	—		
AH2002-DC50A		56	448			83.3	24			20pin connector 4pin power connector (Wire cable)			
AH2004-DC50A		112	869			83.3				20pin connector 6pin power connector (Wire cable)			
AH3002-DC60A	300	54.2	640	1,250		200	24			4.75 to 5.25	Yes	20pin connector 4pin power connector (Wire cable)	Yes
AH3004-DC50A		108.4	1,280			56.5						20pin connector 6pin power connector (Wire cable)	—
AH3004-DC60A		108.4	1,280			200						20pin connector 6pin power connector (Wire cable)	Yes

We can also develop a thermal printhead per customized specifications. Please contact a ROHM sales representative for further details.



Part No. List

Part No. List

Part No.	Page	Part No.	Page	Part No.	Page	Part No.	Page	Part No.	Page
1SS355VM	C84	2SB1708	C29	2SD1383K	C27	BA25DD0W	A34	BA90BC0W	A37
1SS356	C85	2SB1709	C29	2SD1484K	C25	BA25JC5	A36	BA90DD0	A34
1SS380VM	C84	2SB1710	C29	2SD1757K	C25	BA2901	A16	BA90DD0W	A34
1SS390SM	C85	2SB1730	C29	2SD1781K	C25	BA2901S	A16	BA90JC5	A36
1SS400CM	C84	2SB1731	C29	2SD1782K	C25	BA2901Y	A16	BA9741	A51
1SS400CS	C84	2SB1732	C29	2SD1834	C31	BA2902	A10	BA9743A	A51
1SS400SM	C84	2SB1733	C29	2SD1918	C31	BA2902S	A10	BA9744	A51
2SA1036K	C25	2SB852K	C27	2SD1949	C25	BA2902Y	A10, A11	BAJ0BC0	A36
2SA1037AK	C25	2SC2411K	C25	2SD1980	C31	BA2903	A16	BAJ0BC0W	A37
2SA1514K	C25	2SC2412K	C25	2SD2114K	C27	BA2903S	A16	BAJ0CC0	A35
2SA1576A	C25	2SC3837K	C28	2SD2142K	C27	BA2903Y	A16	BAJ0CC0W	A35
2SA1576U3	C25	2SC3838K	C28	2SD2143	C31	BA2904	A10	BAJ2CC0	A35
2SA1576UB	C24	2SC3906K	C25	2SD2153	C31	BA2904S	A10	BAJ2CC0W	A35
2SA1577	C25	2SC4061K	C25	2SD2226K	C27	BA2904Y	A10, A11	BAJ2DD0	A34
2SA1579	C25	2SC4081	C25	2SD2351	C27	BA30BC0	A36	BAJ2DD0W	A34
2SA1579U3	C25	2SC4081U3	C25	2SD2391	C31	BA30BC0W	A37	BAJ5CC0	A35
2SA1774	C25	2SC4081UB	C24	2SD2444K	C25	BA30DD0	A34	BAJ6DD0	A34
2SA1774EB	C24	2SC4082	C28	2SD2537	C31	BA30DD0W	A34	BAJ6DD0W	A34
2SA2018	C25	2SC4083	C28	2SD2652	C25	BA30E00W	A47	BAS116HM	C84
2SA2029	C24	2SC4097	C25	2SD2653	C29	BA30JC5	A36	BAS16HM	C84
2SA2030	C24	2SC4098	C28	2SD2653K	C25	BA3121	A98	BAS21HM	C84
2SA2071P5	C31	2SC4102	C25	2SD2654	C27	BA3123	A98	BAS21VM	C84
2SA2088	C25	2SC4102U3	C25	2SD2656	C25	BA3131	A98	BAS40-04HM	C64
2SA2088U3	C25	2SC4617	C25	2SD2657	C29	BA3259	A47	BAS40-05HM	C64
2SA2094	C29	2SC4617EB	C24	2SD2657K	C25	BA3308	A98	BAS40-06HM	C64
2SA2119K	C25	2SC4618	C28	2SD2661	C31	BA33BC0	A36	BAS40HM	C64
2SAR293P	C31	2SC4713K	C28	2SD2670	C29	BA33BC0W	A37	BAT54AHM	C64
2SAR293P5	C31	2SC4725	C28	2SD2671	C29	BA33D15	A47	BAT54CHM	C64
2SAR340P	C31	2SC4726	C28	2SD2672	C29	BA33D18	A47	BAT54HM	C64
2SAR340Q	C29	2SC4774	C28	2SD2673	C29	BA33DD0	A34	BAT54SHM	C64
2SAR502EB	C24	2SC5585	C25	2SD2674	C29	BA33DD0W	A34	BAV170HM	C84
2SAR502U3	C25	2SC5658	C24	2SD2675	C29	BA33JC5	A36	BAV199HM	C84
2SAR502UB	C24	2SC5661	C28	2SD2696	C24	BA3404	A10	BAV199UM	C84
2SAR512P	C31	2SC5662	C28	2SD2700	C29	BA3472	A12	BAV70HM	C84
2SAR512P5	C31	2SC5663	C24	2SD2701	C29	BA3472R	A12	BAV99HM	C84
2SAR512R	C29	2SC5824	C31	2SD2702	C29	BA3472W	A12	BAW156HM	C84
2SAR513P	C31	2SC5866	C29	2SD2703	C29	BA3472Y	A12	BAW156UM	C84
2SAR513P5	C31	2SC5876	C25	2SD2704K	C27	BA3474	A12	BAW56HM	C84
2SAR513R	C29	2SC5876U3	C25	2SD2707	C27	BA3474R	A12	BC807-16	C26
2SAR514P	C31	2SCR293P	C31	AE2004-DC50A	F15	BA3474W	A12	BC807-25	C26
2SAR514P5	C31	2SCR293P5	C31	AE3004-DC50A	F15	BA3474Y	A12	BC807-40	C26
2SAR514R	C29	2SCR341Q	C29	AG009DGGQ3	C22	BA3662	A36	BC817-16	C26
2SAR522EB	C24	2SCR346P	C31	AH2001-DK50A	F16	BA3834	A100	BC817-25	C26
2SAR522M	C24	2SCR372P	C31	AH2002-DC50A	F16	BA3835	A100	BC817-40	C26
2SAR522UB	C24	2SCR372P5	C31	AH2004-DC50A	F16	BA4510	A15	BC846B	C26
2SAR523EB	C24	2SCR375P	C31	AH3002-DC60A	F16	BA4558	A15	BC846PN	C26
2SAR523M	C24	2SCR375P5	C31	AH3004-DC50A	F16	BA4558R	A15	BC847B	C26
2SAR523UB	C24	2SCR502EB	C24	AH3004-DC60A	F16	BA4558Y	A15	BC847BU3	C26
2SAR533P	C31	2SCR502U3	C25	BA00BC0W	A37	BA4560	A15	BC847C	C26
2SAR533P5	C31	2SCR502UB	C24	BA00CC0W	A35	BA4560R	A15	BC848B	C26
2SAR542F3	C31	2SCR512P	C31	BA00DD0W	A34	BA4560Y	A15	BC848BW	C26
2SAR542P	C31	2SCR512P5	C31	BA00JC5W	A36	BA4564R	A15	BC856B	C26
2SAR543R	C29	2SCR512R	C29	BA033CC0	A35	BA4564W	A16	BC857B	C26
2SAR544P	C31	2SCR513P	C31	BA033CC0W	A35	BA4580R	A15	BC857BU3	C26
2SAR544P5	C31	2SCR513P5	C31	BA03CC0	A35	BA4580Y	A15	BC857C	C26
2SAR544R	C29	2SCR513R	C29	BA03CC0W	A35	BA4584	A15	BC858B	C26
2SAR552P	C31	2SCR514P	C31	BA05CC0	A35	BA4584R	A15	BC858BW	C26
2SAR552P5	C31	2SCR514P5	C31	BA05CC0W	A35	BA4584Y	A15	BCX17	C26
2SAR553P	C31	2SCR514R	C29	BA06CC0	A35	BA50BC0	A36	BCX19	C26
2SAR553P5	C31	2SCR522EB	C24	BA06CC0W	A35	BA50BC0W	A37	BD00C0AW	A35, A36
2SAR553R	C29	2SCR522M	C24	BA07CC0	A35	BA50DD0	A34	BD00D0AW	A34
2SAR554P	C31	2SCR522UB	C24	BA07CC0W	A35	BA50DD0W	A34	BD00FA1W	A36
2SAR554P5	C31	2SCR523EB	C24	BA08CC0	A35	BA50JC5	A36	BD00FC0W	A35
2SAR554R	C29	2SCR523M	C24	BA08CC0W	A35	BA5417	A97	BD00FD0W	A34
2SAR562F3	C31	2SCR523UB	C24	BA09CC0	A35	BA60BC0	A36	BD00GA3M	A39
2SAR572D3	C31	2SCR533P	C31	BA09CC0W	A35	BA60BC0W	A37	BD00GA3W	A38
2SAR573D3	C31	2SCR533P5	C31	BA1117	A33	BA60JC5	A36	BD00GA5M	A38
2SAR574D3	C31	2SCR542F3	C31	BA12003B	A18, C53	BA6219B	A69	BD00GA5W	A38
2SAR586D3	C31	2SCR542P	C31	BA12004B	A18, C53	BA6247	A69	BD00GC0M	A37
2SARA41C	C25	2SCR543R	C29	BA14741	A15	BA6285	A68	BD00GC0W	A37
2SB1197K	C25	2SCR544P	C31	BA15218	A15	BA6285A	A68	BD00HA3M	A41
2SB1198K	C25	2SCR544P5	C31	BA15532	A15	BA6287	A68	BD00HA3W	A41
2SB1275	C31	2SCR544R	C29	BA15BC0	A36	BA6406	A73	BD00HA5M	A40
2SB1316	C31	2SCR552P	C31	BA15BC0W	A37	BA6506	A73	BD00HA5W	A40
2SB1427	C31	2SCR552P5	C31	BA15DD0	A34	BA6901	A73	BD00HC0M	A40
2SB1561	C31	2SCR553P	C31	BA15DD0W	A34	BA6920	A68	BD00HC0W	A40
2SB1590K	C25	2SCR553P5	C31	BA15JC5	A36	BA70BC0	A36	BD00HC5M	A39
2SB1689	C25	2SCR553R	C29	BA18BC0	A36	BA70BC0W	A37	BD00HC5W	A39
2SB1690	C29	2SCR554P	C31	BA18BC0W	A37	BA78Mxx	A33	BD00IA5M	A42
2SB1690K	C25	2SCR554P5	C31	BA18DD0	A34	BA78xx	A33	BD00IA5W	A42
2SB1694	C25	2SCR554R	C29	BA18DD0W	A34	BA80BC0	A36	BD00IC0M	A41
2SB1695	C29	2SCR562F3	C31	BA18JC5	A36	BA80BC0W	A37	BD00IC0W	A41
2SB1695K	C25	2SCR572D3	C31	BA2107	A15	BA80JC5	A36	BD00KA5W	A42
2SB1697	C31	2SCR573D3	C31	BA2115	A15	BA82902Y	A11	BD1020	A89
2SB1705	C29	2SCR574D3	C31	BA25BC0	A36	BA82904Y	A11	BD10IA5M	A42
2SB1706	C29	2SCR586D3	C31	BA25BC0W	A37	BA8391	A16	BD10IA5W	A42
2SB1707	C29	2SCRC41C	C25	BA25DD0	A34	BA90BC0	A36	BD10IC0M	A41

Part No. List

Part No.	Page	Part No.	Page	Part No.	Page	Part No.	Page	Part No.	Page
BD10IC0W	A41	BD2068	A61	BD30KA5	A42	BD37521	A99	BD50HA3M	A41
BD10KA5	A42	BD2069	A61	BD30KA5W	A42	BD37522	A99	BD50HA3W	A41
BD10KA5W	A42	BD2200	A62	BD3375	A29	BD37523	A99	BD50HA5M	A40
BD11600	A23	BD2201	A62	BD3376	A29	BD37524	A100	BD50HA5W	A40
BD11601	A23	BD2202	A62	BD3377	A29	BD37531	A100	BD50HC0M	A40
BD11603	A23	BD2204	A62	BD33C0A	A35	BD37532	A100	BD50HC0W	A40
BD11670	A23	BD2206	A62	BD33C0AW	A35, A36	BD37533	A100	BD50HC5M	A39
BD12730	A13	BD2220	A60	BD33FA1	A36	BD37534	A100	BD50HC5W	A39
BD12732	A13	BD2221	A60	BD33FC0	A35	BD37541	A100	BD521GO	A81
BD12734	A13	BD2222	A60	BD33FC0W	A35	BD37542	A100	BD5291	A16
BD12IA5M	A42	BD2224	A60	BD33FD0W	A34	BD37543	A100	BD52Exx Series	A65
BD12IA5W	A42	BD2225	A60	BD33GA3M	A39	BD37544	A100	BD52xx Series	A65, A66
BD12IC0M	A41	BD2226	A60	BD33GA3W	A38	BD37545	A100	BD53Exx Series	A65
BD12IC0W	A41	BD2227	A60	BD33GA5M	A38	BD3775A	A66	BD53xx Series	A65, A66
BD12KA5	A42	BD2232	A60	BD33GA5W	A38	BD37A19	A66	BD5413	A97
BD12KA5W	A42	BD2233	A60	BD33GC0M	A37	BD37A41	A66	BD5423A	A97
BD1321	A14	BD2240	A60	BD33GC0W	A37	BD3811	A99	BD5424	A97
BD14000	A63	BD2241	A60	BD33HA3M	A41	BD3812	A98	BD5426	A97
BD15FD0W	A34	BD2242	A60	BD33HA3W	A41	BD3814	A98	BD5460	A96
BD15GA3M	A39	BD2243	A60	BD33HA5M	A40	BD3816	A99	BD5461	A96
BD15GA3W	A38	BD2244	A60	BD33HA5W	A40	BD3817	A99	BD5465	A96
BD15GA5M	A38	BD2245	A60	BD33HC0M	A40	BD3818	A99	BD5466	A96
BD15GA5W	A38	BD2246	A60	BD33HC0W	A40	BD3841	A99	BD5467	A96
BD15GC0M	A37	BD2247	A60	BD33HC5M	A39	BD3843	A99	BD5468	A96
BD15GC0W	A37	BD2248	A60	BD33HC5W	A39	BD3870	A99	BD5469	A96
BD15HA3M	A41	BD2262	A60	BD33IA5M	A42	BD3871	A99	BD54FA1	A36
BD15HA3W	A41	BD22621	A60	BD33IA5W	A42	BD3872	A99	BD555BK	A81
BD15HA5M	A40	BD2264	A60	BD33IC0M	A41	BD3873	A99	BD5632	A96
BD15HA5W	A40	BD22641	A60	BD33IC0W	A41	BD3883	A100	BD5634	A96
BD15HC0M	A40	BD2265	A60	BD33KA5	A42	BD39000	A57	BD5638	A96
BD15HC0W	A40	BD2266	A60	BD33KA5W	A42	BD39001	A57	BD57011A	A62
BD15HC5M	A39	BD2267	A60	BD3401	A100	BD39002	A57	BD57015	A62
BD15HC5W	A39	BD2268	A60	BD3402	A100	BD39012	A57	BD57020	A62
BD15IA5M	A42	BD2269	A60	BD3403	A100	BD3925	A46	BD57021	A62
BD15IA5W	A42	BD2270	A62	BD3433	A100	BD41000	A29	BD6040	A63
BD15IC0M	A41	BD25FD0W	A34	BD3460	A100	BD41030	A29	BD6041	A63
BD15IC0W	A41	BD25GA3M	A39	BD34602	A100	BD4142	A65	BD6042	A63
BD15KA5	A42	BD25GA3W	A38	BD3461	A100	BD4233	A56	BD6044	A63
BD15KA5W	A42	BD25GA5M	A38	BD3464	A100	BD4234	A56	BD6046	A63
BD1604	A81	BD25GA5W	A38	BD3465	A100	BD42500	A46	BD6047A	A63
BD16805	A71	BD25GC0M	A37	BD34700	A98	BD42530	A46	BD6049	A63
BD16922	A68	BD25GC0W	A37	BD34701	A98	BD42540	A46	BD6071	A80
BD16933	A68	BD25HA3M	A41	BD34704	A98	BD4269	A46	BD6072	A80
BD16936	A68	BD25HA3W	A41	BD34705	A98	BD4271	A46	BD6079	A80
BD16938	A68	BD25HA5M	A40	BD3471	A98	BD42754	A46	BD60A00	A80
BD16950	A68	BD25HA5W	A40	BD34710	A98	BD433M2	A34	BD60A60	A80
BD1754	A82	BD25HC0M	A40	BD3473	A98	BD433M2W	A34	BD60FC0W	A35
BD18340	A82	BD25HC0W	A40	BD3474	A98	BD433M5	A34	BD60GA3M	A39
BD18341	A82	BD25HC5M	A39	BD3490	A99	BD433M5W	A34	BD60GA3W	A38
BD18351	A80	BD25HC5W	A39	BD3491	A99	BD450M2	A34	BD60GA5M	A38
BD18FD0W	A34	BD25IA5M	A42	BD3504	A46	BD450M2W	A34	BD60GA5W	A38
BD18GA3M	A39	BD25IA5W	A42	BD3506	A46	BD450M5	A34	BD60GC0M	A37
BD18GA3W	A38	BD25IC0M	A41	BD3507	A46	BD450M5W	A34	BD60GC0W	A37
BD18GA5M	A38	BD25IC0W	A41	BD3508	A46	BD45Exx1 Series	A66	BD60HA3M	A41
BD18GA5W	A38	BD25KA5	A42	BD3509	A46	BD45Exx2 Series	A66	BD60HA3W	A41
BD18GC0M	A37	BD25KA5W	A42	BD3512	A46	BD45Exx5 Series	A66	BD60HA5M	A40
BD18GC0W	A37	BD2606	A81	BD3521	A46	BD45xx1 Series	A65	BD60HA5W	A40
BD18HA3M	A41	BD26IC0W	A41	BD3533	A47	BD45xx2 Series	A65	BD60HC0M	A40
BD18HA3W	A41	BD27400	A96	BD3539	A47	BD45xx5 Series	A65	BD60HC0W	A40
BD18HA5M	A40	BD2802	A82	BD35390	A47	BD46Exx1 Series	A66	BD60HC5M	A39
BD18HA5W	A40	BD2808	A82	BD35395	A47	BD46Exx2 Series	A66	BD60HC5W	A39
BD18HC0M	A40	BD2812	A82	BD3540	A46	BD46Exx5 Series	A66	BD61243	A73
BD18HC0W	A40	BD28412	A96	BD3541	A46	BD46xx1 Series	A65	BD61245	A73
BD18HC5M	A39	BD28623	A97	BD3550	A46	BD46xx2 Series	A65	BD61250	A73
BD18HC5W	A39	BD3010A	A46	BD3551	A46	BD46xx5 Series	A65	BD6142A	A80
BD18IA5M	A42	BD3020	A46	BD3552	A46	BD47xx Series	A65	BD6164	A80
BD18IA5W	A42	BD3021	A46	BD3570Y	A33	BD48Exx Series	A64, A66	BD62011A	A74
BD18IC0M	A41	BD30FC0W	A35	BD3571Y	A33	BD48Kxx Series	A64	BD62012A	A74
BD18IC0W	A41	BD30FD0W	A34	BD3572Y	A33	BD48Lxx Series	A64	BD62013A	A74
BD18KA5	A42	BD30GA3M	A39	BD3573Y	A33	BD48xx Series	A64	BD62014A	A74
BD18KA5W	A42	BD30GA3W	A38	BD3574Y	A33	BD49101A	A55	BD6210	A68
BD1CIC0W	A41	BD30GA5M	A38	BD3575Y	A33	BD49Exx Series	A64, A66	BD6211	A68
BD1HC500	A23	BD30GA5W	A38	BD3650	A34	BD49Kxx Series	A64	BD62110A	A68
BD1HD500	A23	BD30GC0M	A37	BD37033	A100	BD49Lxx Series	A64	BD6212	A68
BD1LB500	A23	BD30GC0W	A37	BD37034	A100	BD49xx Series	A64	BD6220	A68
BD2041A	A61	BD30HA3M	A41	BD37067	A100	BD50C0A	A35	BD6221	A68
BD2042A	A61	BD30HA3W	A41	BD37068	A100	BD50C0AW	A35, A36	BD62210A	A75
BD2045A	A61	BD30HA5M	A40	BD37069	A100	BD50FA1	A36	BD6222	A68
BD2046A	A61	BD30HA5W	A40	BD37201	A46	BD50FC0	A35	BD62220A	A75
BD2051A	A61	BD30HC0M	A40	BD37210	A46	BD50FC0W	A35	BD62222	A68
BD2052A	A61	BD30HC0W	A40	BD37215	A46	BD50FD0W	A34	BD6225	A68
BD2055A	A61	BD30HC5M	A39	BD37503	A99	BD50GA3M	A39	BD6226	A68
BD2056A	A61	BD30HC5W	A39	BD37511	A99	BD50GA3W	A38	BD6230	A68
BD2061A	A61	BD30IA5M	A42	BD37512	A99	BD50GA5M	A38	BD6231	A68
BD2062	A61	BD30IA5W	A42	BD37513	A99	BD50GA5W	A38	BD6232	A68
BD2065A	A61	BD30IC0M	A41	BD37514	A99	BD50GC0M	A37	BD62321	A68
BD2066	A61	BD30IC0W	A41	BD37515	A99	BD50GC0W	A37	BD6236	A68

Part No. List

Part No.	Page	Part No.	Page	Part No.	Page	Part No.	Page	Part No.	Page
BD6237	A68	BD6961	A72	BD8119	A81	BD8962	A49	BD95831	A50
BD6290	A70	BD6962	A72	BD8132	A55	BD8963	A49	BD95841	A50
BD63001A	A71	BD6964	A72	BD8139A	A55	BD89630	A49	BD95861	A50
BD63002A	A71	BD6965	A72	BD8143	A55	BD8964	A49	BD9596B	A57
BD63005A	A71	BD6966	A72	BD8149	A55	BD8966	A49	BD9611	A51
BD63006	A71	BD6967	A72	BD8152	A51	BD8967	A49	BD9634	A56
BD63007	A71	BD6968	A72	BD8153	A55	BD8LA700	A23	BD9639	A56
BD63035	A71	BD6971	A73	BD8157	A55	BD8LB600	A23	BD9701	A50
BD63242	A73	BD69730	A73	BD8158	A51	BD9015	A52	BD9702	A50
BD63251	A73	BD69740	A73	BD8160A	A55	BD9016	A52	BD9703	A50
BD6326	A73	BD6981	A72	BD8162A	A55	BD9035A	A52	BD9757	A56
BD63441A	A73	BD6982	A72	BD8163	A55	BD9060	A52	BD9778	A50
BD63510A	A70	BD69830	A72	BD8165	A55	BD90610	A52	BD9845	A51
BD63511	A70	BD6994	A73	BD8166	A55	BD90620	A52	BD9848	A51
BD63520A	A70	BD6995	A73	BD8179	A55	BD90640	A52	BD9851	A51
BD63521	A70	BD7003	A47	BD81842	A55	BD90C0A	A35	BD9859	A50
BD63524A	A70	BD7004	A47	BD81849	A55	BD90C0AW	A36	BD9862	A55
BD63525A	A70	BD70511	A47	BD81870	A55	BD90FC0W	A35	BD9865	A56
BD63536	A51	BD70522	A49	BD81A24	A81	BD90FD0W	A34	BD9866	A56
BD63565	A68	BD70FC0W	A35	BD81A44	A81	BD90GA3M	A39	BD9870	A50
BD63573	A68	BD70GA3M	A39	BD82000	A61	BD90GA3W	A38	BD9873	A50
BD6360	A78	BD70GA3W	A38	BD82001	A61	BD90GA5M	A38	BD9874	A50
BD63610A	A70	BD70GA5M	A38	BD82004	A61	BD90GA5W	A38	BD99010	A52
BD63620A	A70	BD70GA5W	A38	BD82005	A61	BD90GC0M	A37	BD99011	A52
BD6369	A78	BD70GC0M	A37	BD82006	A61	BD90GC0W	A37	BD99950	A63
BD6370	A76	BD70GC0W	A37	BD82007	A61	BD9102	A49	BD99A41	A66
BD63710A	A69	BD70HA3M	A41	BD82020	A61	BD9104	A49	BD9A100	A49
BD63715A	A69, A75	BD70HA3W	A41	BD82021	A61	BD9106	A49	BD9A101	A49
BD63720A	A69	BD70HA5M	A40	BD82022	A61	BD9107	A49	BD9A300	A49
BD63725B	A69	BD70HA5W	A40	BD82023	A61	BD9109	A49	BD9A301	A49
BD6373	A76	BD70HC0M	A40	BD82024	A61	BD9110	A49	BD9A302	A49
BD63730	A69	BD70HC0W	A40	BD82025	A61	BD9111	A49	BD9A400	A49
BD6376	A68, A76	BD70HC5M	A39	BD82028	A61	BD9120	A49	BD9A600	A49
BD6380	A70	BD70HC5W	A39	BD82029	A61	BD9122	A49	BD9B100	A49
BD63801	A70, A75	BD71801A	A56	BD8203	A74	BD9123	A49	BD9B200	A49
BD6381	A70	BD71805	A57	BD82030	A61	BD9130	A49	BD9B300	A49
BD6382	A70	BD71815A	A57	BD82031	A61	BD9132	A49	BD9B301	A49
BD63821	A75	BD71L4Lx Series	A65	BD82032	A61	BD9134	A49	BD9B304	A49
BD63823	A75	BD7212	A56	BD82033	A61	BD91361	A49	BD9B331	A49
BD6383	A69	BD7213	A56	BD82034	A61	BD91364B	A49	BD9B333	A49
BD63843	A70	BD7214	A56	BD82035	A61	BD9137	A49	BD9B400	A49
BD63847	A70	BD733L2	A34	BD8205	A74	BD9139	A49	BD9B500	A49
BD6385	A69	BD733L5	A34	BD82061	A61	BD91409	A63	BD9B600	A49
BD63860	A70	BD7411	A88	BD82065	A61	BD9141	A50	BD9C301	A50
BD6387	A69	BD750L2	A34	BD8226	A74	BD91411	A23	BD9C401	A50
BD6389	A69	BD750L5	A34	BD8229	A74	BD91501	A51	BD9C501	A50
BD63910	A69	BD7541	A13	BD8255	A75	BD9151	A51	BD9C601	A50
BD63920	A69	BD7541S	A13	BD8256	A75	BD9152	A51	BD9D320	A50
BD6393	A70	BD7542	A13	BD8263	A74	BD9161	A49	BD9D321	A50
BD63940	A70	BD7542S	A13	BD8266	A74	BD9206	A82	BD9D322	A50
BD6395	A70	BD7561	A11	BD8271	A74	BD9207	A81	BD9D323	A50
BD63960	A70	BD7561S	A11	BD8303	A51	BD9227	A50	BD9E100	A50
BD6422	A71	BD7562	A11	BD8306	A51	BD9251	A89	BD9E101	A50
BD6423	A71	BD7562S	A11	BD8311	A51	BD9271	A82	BD9E102	A50
BD6425	A71	BD7602	A47	BD8312	A50	BD9305A	A51	BD9E151	A50
BD6516	A61	BD7672B	A58	BD8313	A50	BD9306A	A51	BD9E300	A50
BD6517	A61	BD7673A	A58	BD8314	A51	BD9325	A50	BD9E301	A50
BD6519	A61	BD7678F	A58	BD8316	A51	BD9326	A50	BD9E302	A50
BD6520	A62	BD7679	A58	BD8317	A51	BD9327	A50	BD9E303	A50
BD6522	A62	BD7682	A59	BD8325	A59	BD9328	A50	BD9G101	A50
BD6524	A62	BD7683	A59	BD8355	A56	BD93291	A51	BD9G201	A52
BD6528	A62	BD7684	A59	BD8372	A82	BD9329A	A50	BD9G341A	A50
BD6529	A62	BD7685	A59	BD83732	A82	BD9355	A56	BD9G401	A52
BD6538	A60	BD7690	A58	BD83733	A82	BD9361	A56	BD9S000	A52
BD65491	A68, A76	BD7691	A58	BD8374	A82	BD93941	A80	BD9S100	A52
BD65492	A68, A76	BD7710	A80	BD8378	A82	BD9397	A80	BD9S200	A52
BD65494	A68, A76	BD7757	A80	BD8379	A82	BD93W20	A30	BD9S300	A52
BD65496	A68, A76	BD7763	A75	BD8381A	A81	BD93W26	A30	BD9S301	A52
BD65499	A76	BD7830	A96	BD8664	A63	BD9411	A80	BD9S400	A52
BD6583	A80	BD7836	A96	BD8665	A63	BD94121	A81	BD9V100	A52
BD6586	A80	BD7931	A74	BD8668	A63	BD9413	A80	BD9V101	A50
BD65B60	A80	BD7F100	A59	BD87A28	A66	BD9416	A80	BDJ0FC0W	A35
BD65D00	A80	BD7F200	A59	BD87A29	A66	BD9423	A80	BDJ0GA3M	A39
BD6701	A73	BD7J200	A59	BD87A34	A66	BD9478	A82	BDJ0GA3W	A38
BD6735	A68, A76	BD7J200EF	A59	BD87A41	A66	BD9479	A80	BDJ0GA5M	A38
BD6736	A68, A76	BD80C0A	A35	BD88200	A97	BD9483	A80	BDJ0GA5W	A38
BD6753	A76	BD80C0AW	A36	BD88210	A97	BD9486	A80	BDJ0GC0M	A37
BD6758	A76	BD80FC0W	A35	BD88215	A97	BD9528A	A51	BDJ0GC0W	A37
BD6761	A71, A75	BD80FD0W	A34	BD88220	A97	BD9535	A51	BDJ2FA1	A36
BD6762	A71, A75	BD80GA3M	A39	BD88400	A97	BD9536	A51	BDJ2FC0W	A35
BD67929	A71, A75	BD80GA3W	A38	BD88410	A97	BD95500	A50	BDJ2FD0W	A34
BD68610	A70	BD80GA5M	A38	BD88415	A97	BD95513	A50	BDJ2GA3M	A39
BD68620	A70	BD80GA5W	A38	BD88420	A97	BD95514	A50	BDJ2GA3W	A38
BD68710	A69	BD80GC0M	A37	BD8876	A98	BD95601	A51	BDJ2GA5M	A38
BD68715	A69, A75	BD80GC0W	A37	BD8878	A98	BD95602	A51	BDJ2GA5W	A38
BD68720	A69	BD81010	A55	BD8960	A49	BD95821	A50	BDJ2GC0M	A37
BD6889	A76	BD81026	A55	BD8961	A49	BD95830	A51	BDJ2GC0W	A37

Part No.	Page	Part No.	Page	Part No.	Page	Part No.	Page	Part No.	Page
BDJ5FC0W	A35	BH76331	A102	BM521Q25	A81	BP5041A	F3	BSS123	C3, C21
BDJ5FD0W	A34	BH76332	A102	BM531Q11	A81	BP5041A5	F3	BSS138BK	C3, C21
BDJ6FD0W	A34	BH76333	A102	BM533Q11	A81	BP5041B15	F3	BSS138BKW	C3, C21
BDJxxx0 Series	A89	BH76360	A102	BM60014	A59	BP5045A	F3	BSS138W	C3, C21
BDS2EJAA	A62	BH76361	A102	BM60051	A59	BP5045A5	F3	BSS4130	C26
BH12PB1W	A45	BH76362	A102	BM60055	A59	BP5047A24	F3	BSS5130	C26
BH15M0AW	A43	BH76363	A102	BM6101	A59	BP5047B15	F3	BSS63	C26
BH15PB1W	A45	BH7649	A102	BM6102	A59	BP5048	F3	BSS64	C26
BH15RB1W	A45	BH76706	A102	BM6104	A59	BP5048-15	F3	BSS670	C3, C21
BH1603	A88	BH7673	A102	BM6108	A59	BP5048-24	F3	BSS84	C3, C21
BH1620	A88	BH76806	A102	BM6202	A74	BP5053-12	F3	BSS84W	C3, C21
BH1680	A88	BH76809	A102	BM6203	A74	BP5055-12	F3	BU10JA2M	A45
BH1682	A88	BH76812	A102	BM6204	A74	BP5061	F3	BU10JA2V	A45
BH1721	A88	BH76816	A102	BM6205	A74	BP5062A	F3	BU11JA2M	A45
BH1726	A88	BH76906	A102	BM6206	A74	BP5062A5	F3	BU12JA2M	A45
BH1730	A88	BH76909	A102	BM6207	A74	BP5063-5	F3	BU12JA2V	A45
BH1745	A88	BH76912	A102	BM6208	A74	BP5065C	F3	BU12SD2M	A44
BH1747	A88	BH76916	A102	BM6209	A74	BP5067-12	F3	BU1523	A103
BH1790	A88	BH7824	A96	BM63363S-VA	B14	BP5067-15	F3	BU1573	A103
BH1792	A88	BH7826	A96	BM63363S-VC	B14	BP5068-15	F3	BU15JA2M	A45
BH18M0AW	A43	BH7881	A98	BM63364S-VA	B14	BP5068A	F3	BU15JA2V	A45
BH18PB1W	A45	BH7884	A98	BM63364S-VC	B14	BP5068A24	F3	BU15SD2M	A44
BH18RB1W	A45	BM1050A	A58	BM63563S-VA	B14	BP5122	F4	BU15TA2W	A44
BH18SA3W	A45	BM1051	A58	BM63563S-VC	B14	BP5220A	F4	BU16501	A82
BH1900	A89	BM1383A	A89	BM63564S-VA	B14	BP5221A	F4	BU17074	A28
BH20M0AW	A43	BM1386	A89	BM63564S-VC	B14	BP5222A	F4	BU17101A	A28
BH21M0AW	A43	BM1C101	A58	BM63763S-VA	B14	BP5223	F4	BU17102A	A28
BH2219	A26	BM1C102	A58	BM63763S-VC	B14	BP5224-33	F4	BU1840A	A63
BH2220	A26	BM1P061	A58	BM63764S-VA	B14	BP5226-18	F4	BU18JA2D	A45
BH2221	A26	BM1P062	A58	BM63764S-VC	B14	BP5293-12	F4	BU18JA2M	A45
BH2223	A26	BM1P065	A58	BM63767S-VA	B14	BP5293-33	F4	BU18JA2V	A45
BH2226	A26	BM1P066	A58	BM63767S-VC	B14	BP5293-50	F4	BU18SA4W	A45
BH2227	A26	BM1P067	A58	BM63963S-VA	B14	BP5324A	F4	BU18SD2M	A44
BH2228	A26	BM1P068	A58	BM63963S-VC	B14	BP5510-24	F4	BU18SD5W	A42
BH25M0AW	A43	BM1P101	A58	BM63964S-VA	B14	BP5512A	F4	BU18TA2W	A44
BH25NB1W	A45	BM1P102	A58	BM63964S-VC	B14	BP5710-1	F3	BU1CJA2M	A45
BH25PB1W	A45	BM1P105	A58	BM63967S-VA	B14	BP5716	F3	BU1CJA2V	A45
BH25RB1W	A45	BM1P107	A58	BM63967S-VC	B14	BP5717	F3	BU1S12S1	A26
BH26M0AW	A43	BM1Q002	A58	BM65364S-VA	B14	BP5718A12	F3	BU2050	A22
BH2715	A26	BM1Q021	A58	BM65364S-VC	B14	BP5720-5	F3	BU2090	A22
BH27M0AW	A43	BM1Q041	A58	BM66002	A60	BP5722A12	F3	BU2092	A22
BH28M0AW	A43	BM1R00146	A59	BM67290	A60	BP5725	F3	BU2098	A22
BH28NB1W	A45	BM1R00147	A59	BM81004	A55	BP5726-15	F3	BU2099	A22
BH28PB1W	A45	BM1R00148	A59	BM81028A	A55	BP5728	F3	BU21023	A89
BH28RB1W	A45	BM1R00149	A59	BM81100	A55	BP5729	F3	BU21024	A89
BH28SA3W	A45	BM1R00150	A59	BM81110	A55	BP5811	F4	BU21025	A89
BH29M0AW	A43	BM28720	A96	BM81810	A55	BR24Axx-WM Series	A6	BU21026	A89
BH29NB1W	A45	BM28723	A96	BM91AD2-01	A28	BR24C21	A5	BU21027	A89
BH29PB1W	A45	BM2LB110	A23	BM92A11	A30	BR24Gxxx-3A Series	A4	BU21028	A89
BH29RB1W	A45	BM2LB150	A23	BM92A12	A30	BR24Gxxx-3 Series	A4	BU21029	A89
BH2JNB1W	A45	BM2LB300	A23	BM92A13	A30	BR24Txx-3AM Series	A6	BU21072	A89
BH30M0AW	A43	BM2LC105	A23	BM92A14	A30	BR25Axxx-3M Series	A6	BU21077	A89
BH30NB1W	A45	BM2P011	A58	BM92A15	A30	BR25Gxxx-3 Series	A4	BU21078	A89
BH30PB1W	A45	BM2P012	A58	BM92A20	A30	BR25Hxxx-2AC Series	A6	BU21079	A89
BH30RB1W	A45	BM2P013	A58	BM92A21	A30	BR25Hxxx-2C Series	A6	BU21170	A89
BH30SA3W	A45	BM2P014	A58	BM92A26	A30	BR25S128GUZ-W	A5	BU21180	A89
BH31M0AW	A43	BM2P015	A58	BM92A30	A30	BR34E02	A5	BU2152	A22
BH31NB1W	A45	BM2P016	A58	BM92A31	A30	BR34L02	A5	BU22210	A26
BH31PB1W	A45	BM2P01A	A58	BM92A32	A30	BR93Axx-WM Series	A6	BU2280	A20
BH31RB1W	A45	BM2P01B	A58	BM92A33	A30	BR93Gxx-3/3A/3B Series	A5	BU2360	A20
BH32M0AW	A43	BM2P031	A58	BM92A34	A30	BR93Hxx-2C Series	A6	BU2362	A20
BH33M0AW	A43	BM2P032	A58	BM92A35	A30	BRCA016GWZ-W	A5	BU2363	A20
BH33NB1W	A45	BM2P033	A58	BM92A50	A30	BRCB008GWZ-3	A5	BU2394	A20
BH33PB1W	A45	BM2P034	A58	BM92A56	A30	BRCB016GWL-3	A5	BU2396	A20
BH33RB1W	A45	BM2P0391	A58	BM92A70	A30	BRCB032GWZ-3	A5	BU24020	A77
BH34M0AW	A43	BM2P051	A58	BM94715	A101	BRCB064GWZ-3	A5	BU24031	A77
BH3544	A97	BM2P052	A58	BM94803A	A101	BRCD016GWZ-3	A5	BU24033	A77
BH3547	A97	BM2P053	A58	BP3580	F6	BRCCE064GWZ-3	A5	BU24035	A77
BH3548	A97	BM2P054	A58	BP3591	F6	BRCF016GWZ-3	A5	BU24036	A77
BH5510	A75	BM2P074K	A58	BP3595	F6	BRCG016GWZ-3	A5	BU24038	A77
BH5511	A75	BM2P091	A58	BP3599	F6	BRCH064GWZ-3	A5	BU2505	A26
BH6062	A56	BM2P092	A58	BP359B	F6	BS2101	A59	BU2506	A26
BH6172	A56	BM2P093	A58	BP35A1	F6	BS2103	A59	BU2507	A26
BH6173	A56	BM2P094	A58	BP35C0	F6	BS2114	A59	BU2508	A26
BH6174	A56	BM2P095	A58	BP35C2	F6	BS2130	A59	BU25JA2M	A45
BH6176	A56	BM2P109T	A57	BP5033-12	F3	BSM080D12P2C008	B7	BU25JA2V	A45
BH6178	A56	BM2P129T	A57	BP5034D12	F3	BSM120C12P2C201	B7	BU25SA4W	A45
BH6179	A56	BM2P135T	A57	BP5034D15	F3	BSM120D12P2C005	B7	BU25SD2M	A44
BH6260	A23	BM2P137TK	A57	BP5034D24	F3	BSM180C12P2E202	B7	BU25TA2W	A44
BH6578	A74	BM2P139T	A57	BP5034D5	F3	BSM180C12P3C202	B7	BU26154	A103
BH67173	A73	BM2P159P	A57	BP5035A5	F3	BSM180D12P2C101	B7	BU26156	A103
BH6766	A72	BM2P159T1	A57	BP5037B12	F3	BSM180D12P2E002	B7	BU26503	A82
BH76106	A102	BM2P161W	A57	BP5037B15	F3	BSM180D12P3C007	B7	BU26507	A82
BH76109	A102	BM2P163W	A57	BP5038A1	F3	BSM300C12P3E201	B7	BU26TA2W	A44
BH76112	A102	BM2P249Q	A57	BP5039-15	F3	BSM300D12P2E001	B7	BU27TA2W	A44
BH76206	A102	BM2P249T	A57	BP5039A	F3	BSM400D12P3G001	B7	BU28JA2D	A45
BH76330	A102	BM2PA96	A58	BP5039B12	F3	BSM600D12P3G002	B7	BU28JA2M	A45

Part No. List

Part No.	Page	Part No.	Page	Part No.	Page	Part No.	Page	Part No.	Page
BU28JA2W	A45	BU64981A	A78	BU7481S	A12	BU9891GUL-W	A5	DTA023JEB	C44
BU28SA4W	A45	BU64985	A78	BU7485	A12	BU9897GUL-W	A5	DTA023JM	C44
BU28SD2M	A44	BU64987	A78	BU7485S	A12	BU99022	A5	DTA023JUB	C45
BU28TA2W	A44	BU6521	A103	BU7486	A12	BUS1DJCO	A62	DTA023YEB	C44
BU29TA2W	A44	BU6650	A47	BU7486S	A12	BUS1DJC3	A62	DTA023YM	C44
BU2FSA4W	A45	BU6651	A47	BU7487	A12	BUxxTD2W Series	A44	DTA023YUB	C45
BU2JJA2M	A45	BU6652	A47	BU7487S	A12	BUxxTD3W Series	A44	DTA024EEB	C44
BU2JJA2V	A45	BU6653	A47	BU7495	A12	BV1HD090	A23	DTA024EM	C44
BU2JTA2W	A44	BU6654	A47	BU7495S	A12	BV1LB028	A23	DTA024EUB	C45
BU3087	A20	BU6655	A47	BU7985	A28	BV1LB045	A23	DTA024XEB	C44
BU30JA2M	A45	BU69090	A72	BU7988	A28	BV1LB085	A23	DTA024XM	C44
BU30JA2V	A45	BU6909A	A72	BU8179	A28	BV1LB150	A23	DTA024XUB	C45
BU30SA4W	A45	BU7150	A97	BU82204	A29	BV1LB300	A23	DTA043EEB	C44
BU30SA5W	A42	BU7205	A13	BU82205	A29	BV1LC105	A23	DTA043EM	C44
BU30SD2M	A44	BU7205S	A13	BU8254	A28	BZX84B Series	C77	DTA043EUB	C45
BU30TA2W	A44	BU7230	A17	BU90002	A49	BZX84C Series	C77	DTA043TEB	C44
BU31TA2W	A44	BU7230S	A17	BU90003	A49	CDZC6.8B	C79	DTA043TM	C44
BU32TA2W	A44	BU7231	A17	BU90004	A49	CDZCV5.1B	C79	DTA043TUB	C45
BU33DV5	A51	BU7231S	A17	BU90005	A49	CDZCV6.8B	C79	DTA043XEB	C44
BU33DV7	A51	BU7232	A17	BU90006	A49	CDZV Series	C76	DTA043XM	C44
BU33JA2M	A45	BU7232S	A17	BU90007	A49	CDZ Series	C76	DTA043XUB	C45
BU33JA2V	A45	BU7233	A17	BU90008	A49	CSL0406WBCW	E7	DTA043ZEB	C44
BU33SA4W	A45	BU7233S	A17	BU90009	A49	CSL0701DT	E7	DTA043ZM	C44
BU33SA5W	A42	BU7233Y	A17	BU90023	A49	CSL0701UT	E7	DTA043ZUB	C45
BU33SD2M	A44	BU7241	A13	BU90028	A49	CSL0901BT	E6, E7	DTA044EEB	C44
BU33SD5W	A42	BU7241S	A13	BU90030	A81	CSL0901DT	E6, E7	DTA044EM	C44
BU33TA2W	A44	BU7241Y	A14	BU90054	A49	CSL0901ET	E6, E7	DTA044EUB	C45
BU33UV7	A51	BU7242	A13	BU9006	A49	CSL0901MT	E6, E7	DTA044TEB	C44
BU34DV7	A51	BU7242S	A13	BU90090	A49	CSL0901PT	E6, E7	DTA044TM	C44
BU34TA2W	A44	BU7242Y	A14	BU90104	A49	CSL0901UT	E6, E7	DTA044TUB	C45
BU4030B	A22	BU7244	A13	BU90AD2-01	A28	CSL0901VT	E6, E7	DTA113ZCA	C41
BU4051BC	A22	BU7244S	A13	BU90AL210	A28	CSL0901WT	E6, E7	DTA113ZE	C39
BU4052BC	A22	BU7245	A13	BU90AL211	A28	CSL0901YT	E6, E7	DTA113ZEB	C38
BU4066BC	A22	BU7245S	A13	BU90AM4-03	A28	CSL0902BT	E6, E7	DTA113ZKA	C42
BU4069UB	A22	BU7250	A17	BU90LV047A	A28	CSL0902DT	E6, E7	DTA113ZM	C38
BU4094BC	A22	BU7250S	A17	BU90LV048	A28	CSL0902ET	E6, E7	DTA113ZU3	C41
BU42xx Series	A65	BU7251	A17	BU90LV049A	A28	CSL0902MT	E6, E7	DTA113ZUA	C40
BU43xx Series	A65	BU7251S	A17	BU90R102	A28	CSL0902PT	E6, E7	DTA113ZUB	C39
BU4551B	A22	BU7252	A17	BU90R104	A28	CSL0902UT	E6, E7	DTA114ECA	C41
BU45Kxx2 Series	A65	BU7252S	A17	BU90RT102	A28	CSL0902VT	E6, E7	DTA114EE	C39
BU45Kxx4 Series	A65	BU7253	A17	BU90T81	A28	CSL0902WT	E6, E7	DTA114EEB	C38
BU45Lxx2 Series	A65	BU7253S	A17	BU90T82	A28	CSL0902YT	E6, E7	DTA114EKA	C42
BU45Lxx4 Series	A65	BU7255	A11	BU91501	A85	CSL1001BT	E5	DTA114EM	C38
BU46Kxx2 Series	A65	BU7255S	A11	BU91510	A85	CSL1001ET	E5	DTA114EU3	C41
BU46Kxx4 Series	A65	BU7261	A11	BU91520	A85	CSL1001MT	E5	DTA114EUA	C40
BU46Lxx2 Series	A65	BU7261S	A11	BU91530	A85	CSL1001VT	E5	DTA114EUB	C39
BU46Lxx4 Series	A65	BU7262	A11	BU91600	A85	CSL1001YT	E5	DTA114GUA	C40
BU48xx Series	A65	BU7262S	A11	BU91795	A85	DA204K	C84	DTA114TCA	C41
BU49xx Series	A65	BU7264	A11	BU91796	A85	DA221	C84	DTA114TE	C39
BU4S01	A22	BU7264S	A11	BU91797	A85	DA221M	C84	DTA114TEB	C38
BU4S11	A22	BU7265	A13	BU91799	A85	DA227	C84	DTA114TKA	C42
BU4S584	A22	BU7265S	A13	BU91R63CH-M3BW	A85	DA227Y	C84	DTA114TM	C38
BU4S66	A22	BU7266	A13	BU92001	A29	DA228K	C84	DTA114TU3	C41
BU4S71	A22	BU7266S	A13	BU92747	A29	DA228UM	C84	DTA114TUA	C40
BU4S81	A22	BU7271	A13	BU94605A	A101	DA228WM	C84	DTA114TUB	C39
BU4SU69	A22	BU7271S	A13	BU94607A	A101	DAN202K	C84	DTA114WM	C38
BU52040	A88	BU7275	A13	BU94702A	A101	DAN202UM	C84	DTA114WUA	C40
BU52054	A88	BU7275S	A13	BU94705A	A101	DAN217	C84	DTA114YCA	C41
BU52055	A88	BU7291	A11	BU95306	A84	DAN217UM	C84	DTA114YE	C39
BU5207	A88	BU7291S	A11	BU97501	A84	DAN217WM	C84	DTA114YEB	C38
BU52072	A88	BU7294	A11	BU97510C	A85	DAN222M	C84	DTA114YKA	C42
BU52074	A88	BU7294S	A11	BU97520A	A85	DAN222WM	C84	DTA114YM	C38
BU52075	A88	BU7295	A11	BU97530	A84, A85	DAP202K	C84	DTA114YU3	C41
BU52077	A88	BU7295S	A11	BU97540	A85	DAP202UM	C84	DTA114YUA	C40
BU52078	A88	BU7411	A14	BU97550	A84, A85	DAP222M	C84	DTA114YUB	C39
BU52092	A88	BU7411S	A14	BU97601	A85	DAP222WM	C84	DTA115ECA	C41
BU52095	A88	BU7421	A14	BU97930	A84	DTA013ZEB	C44	DTA115EE	C39
BU52097	A88	BU7421S	A14	BU97931	A84, A85	DTA013ZM	C44	DTA115EEB	C38
BU52098	A88	BU7441	A14	BU97941	A84, A85	DTA013ZUB	C45	DTA115EKA	C42
BU52177	A88	BU7441S	A14	BU9794A	A84	DTA014EEB	C44	DTA115EM	C38
BU52272	A88	BU7442	A14	BU9795	A84	DTA014EM	C44	DTA115EU3	C41
BU52273	A88	BU7442S	A14	BU97950	A84	DTA014EUB	C45	DTA115EUA	C40
BU52274	A88	BU7444	A14	BU9795A	A84, A85	DTA014TEB	C44	DTA115EUB	C39
BU5255	A17	BU7444S	A14	BU9795B	A84	DTA014TM	C44	DTA115GUA	C40
BU5255S	A17	BU7445	A14	BU9796A	A84	DTA014TUB	C45	DTA115TCA	C41
BU5265	A17	BU7445S	A14	BU9797	A85	DTA014YEB	C44	DTA115TUA	C40
BU5265S	A17	BU7461	A12	BU9797A	A84	DTA014YM	C44	DTA123ECA	C41
BU52792	A88	BU7461S	A12	BU9797A	A84	DTA014YUB	C45	DTA123EE	C39
BU64241	A78	BU7462	A12	BU9799	A84	DTA015EEB	C44	DTA123EEB	C38
BU64243	A78	BU7462S	A12	BU9829GUL-W	A5	DTA015EM	C44	DTA123EKA	C42
BU64244	A78	BU7464	A12	BU9832GUL-W	A5	DTA015EUB	C45	DTA123EM	C38
BU64291	A78	BU7464S	A12	BU9833GUL-W	A5	DTA015TEB	C44	DTA123EU3	C41
BU64295	A78	BU7465	A12	BU9847GUL-W	A5	DTA015TM	C44	DTA123EUA	C40
BU64296	A78	BU7465S	A12	BU9873	A20	DTA015TUB	C45	DTA123EUB	C39
BU64297	A78	BU7475	A14	BU9882	A5	DTA023EEB	C44	DTA123JCA	C41
BU64562	A78	BU7475S	A14	BU9883	A5	DTA023EM	C44	DTA123JE	C39
BU64980A	A78	BU7481	A12	BU9889GUL-W	A5	DTA023EUB	C45	DTA123JEB	C38

Part No.	Page	Part No.	Page	Part No.	Page	Part No.	Page	Part No.	Page
DTA123JKA	C42	DTB113ZU	C46	DTC113ZUB	C39	DTC143ECA	C41	DTD543XE	C47
DTA123JMJ	C38	DTB114EC	C46	DTC114ECA	C41	DTC143EE	C39	DTD543XM	C47
DTA123JU3	C41	DTB114EK	C46	DTC114EE	C39	DTC143EEB	C38	DTD543ZE	C47
DTA123JUA	C40	DTB114EU	C46	DTC114EEB	C38	DTC143EKA	C42	DTD543ZM	C47
DTA123JUB	C39	DTB114GC	C46	DTC114EKA	C42	DTC143EM	C38	DTDG14GP	C48
DTA123TCA	C41	DTB114GK	C46	DTC114EM	C38	DTC143EU3	C41	DTDG23YP	C48
DTA123TM	C38	DTB114GU	C46	DTC114EU3	C41	DTC143EUA	C40	ECO 200	F8
DTA123TUA	C40	DTB123EC	C46	DTC114EUA	C40	DTC143EUB	C39	EDK 350	F8
DTA123YCA	C41	DTB123EK	C46	DTC114EUB	C39	DTC143TCA	C41	EDK 400J	F8
DTA123YE	C39	DTB123EU	C46	DTC114GU3	C41	DTC143TE	C39	EDZCV6.8B	C79
DTA123YEB	C38	DTB123TC	C46	DTC114GUA	C40	DTC143TEB	C38	EDZV Series	C76
DTA123YKA	C42	DTB123TK	C46	DTC114TCA	C41	DTC143TKA	C42	EM6J1	C3
DTA123YM	C38	DTB123TU	C46	DTC114TE	C39	DTC143TM	C38	EM6K31	C3
DTA123YU3	C41	DTB123YC	C46	DTC114TEB	C38	DTC143TU3	C41	EM6K33	C3, C21
DTA123YUA	C40	DTB123YK	C46	DTC114TKA	C42	DTC143TUA	C40	EM6K34	C3
DTA123YUB	C39	DTB123YU	C46	DTC114TM	C38	DTC143TUB	C39	EM6K6	C3
DTA124ECA	C41	DTB143EC	C46	DTC114TU3	C41	DTC143XCA	C41	EM6K7	C3
DTA124EE	C39	DTB143EK	C46	DTC114TUA	C40	DTC143XE	C39	EM6M2	C3
DTA124EEB	C38	DTB143EU	C46	DTC114TUB	C39	DTC143XEB	C38	EMA2	C52
DTA124EKA	C42	DTB513ZE	C47	DTC114TUC	C41	DTC143XKA	C42	EMA3	C52
DTA124EM	C38	DTB513ZM	C47	DTC114WU	C40	DTC143XMA	C38	EMA4	C52
DTA124EU3	C41	DTB523YE	C47	DTC114YCA	C41	DTC143XU3	C41	EMA5	C52
DTA124EUA	C40	DTB523YM	C47	DTC114YE	C39	DTC143XUA	C40	EMB10	C50
DTA124EUB	C39	DTB543EE	C47	DTC114YEB	C38	DTC143XUB	C39	EMB11	C50
DTA124TCA	C41	DTB543EM	C47	DTC114YKA	C42	DTC143ZCA	C41	EMB2	C50
DTA124TUA	C40	DTB543XE	C47	DTC114YM	C38	DTC143ZE	C39	EMB3	C50
DTA124XCA	C41	DTB543XM	C47	DTC114YU3	C41	DTC143ZEB	C38	EMB4	C50
DTA124XE	C39	DTB543ZE	C47	DTC114YUA	C40	DTC143ZKA	C42	EMB51	C51
DTA124XEB	C38	DTB543ZM	C47	DTC114YUB	C39	DTC143ZMA	C38	EMB52	C51
DTA124XKA	C42	DTC013ZEB	C44	DTC115ECA	C41	DTC143ZU3	C41	EMB53	C51
DTA124XMA	C38	DTC013ZM	C44	DTC115EE	C39	DTC143ZUA	C40	EMB59	C51
DTA124XU3	C41	DTC013ZUB	C45	DTC115EEB	C38	DTC143ZUB	C39	EMB60	C51
DTA124XUA	C40	DTC014EEB	C44	DTC115EKA	C42	DTC144ECA	C41	EMB61	C51
DTA124XUB	C39	DTC014EM	C44	DTC115EM	C38	DTC144EE	C39	EMB75	C51
DTA143ECA	C41	DTC014EUB	C45	DTC115EU3	C41	DTC144EEB	C38	EMD12	C50
DTA143EE	C39	DTC014TEB	C44	DTC115EUA	C40	DTC144EKA	C42	EMD2	C50
DTA143EEB	C38	DTC014TM	C44	DTC115EUB	C39	DTC144EM	C38	EMD22	C50
DTA143EKA	C42	DTC014TUB	C45	DTC115GU3	C41	DTC144EU3	C41	EMD29	C53
DTA143EM	C38	DTC014YEB	C44	DTC115GUA	C40	DTC144EUA	C40	EMD3	C50
DTA143EU3	C41	DTC014YM	C44	DTC115TCA	C41	DTC144EUB	C39	EMD38	C50
DTA143EUA	C40	DTC014YUB	C45	DTC115TUA	C40	DTC144GUA	C40	EMD4	C50
DTA143EUB	C39	DTC015EEB	C44	DTC123ECA	C41	DTC144TCA	C41	EMD5	C50
DTA143TCA	C41	DTC015EM	C44	DTC123EE	C39	DTC144TUA	C40	EMD52	C51
DTA143TE	C39	DTC015EUB	C45	DTC123EEB	C38	DTC144VCA	C41	EMD53	C51
DTA143TEB	C38	DTC015TEB	C44	DTC123EKA	C42	DTC144VMA	C38	EMD59	C51
DTA143TKA	C42	DTC015TM	C44	DTC123EM	C38	DTC144WCA	C41	EMD6	C50
DTA143TM	C38	DTC015TUB	C45	DTC123EU3	C41	DTC144WMA	C38	EMD62	C51
DTA143TU3	C41	DTC023EEB	C44	DTC123EUA	C40	DTC144WUA	C40	EMD72	C51
DTA143TUA	C40	DTC023EM	C44	DTC123EUB	C39	DTC614TK	C48	EMD9	C50
DTA143TUB	C39	DTC023EUB	C45	DTC123JCA	C41	DTC614TU	C48	EMF5	C35
DTA143XCA	C41	DTC023JEB	C44	DTC123JE	C39	DTC623TK	C48	EMG1	C52
DTA143XE	C39	DTC023JM	C44	DTC123JEB	C38	DTC623TU	C48	EMG11	C52
DTA143XEB	C38	DTC023JUB	C45	DTC123JKA	C42	DTC643TK	C48	EMG2	C52
DTA143XKA	C42	DTC023YEB	C44	DTC123JMA	C38	DTC643TU	C48	EMG3	C52
DTA143XM	C38	DTC023YM	C44	DTC123JU3	C41	DTC914TUB	C48	EMG4	C52
DTA143XU3	C41	DTC023YUB	C45	DTC123JUA	C40	DTC923TUB	C48	EMG5	C52
DTA143XUA	C40	DTC024EEB	C44	DTC123JUB	C39	DTC943TUB	C48	EMG6	C52
DTA143XUB	C39	DTC024EM	C44	DTC123TCA	C41	DTD113EC	C46	EMG8	C52
DTA143ZCA	C41	DTC024EUB	C45	DTC123TM	C38	DTD113EK	C46	EMG9	C52
DTA143ZE	C39	DTC024XEB	C44	DTC123TUA	C40	DTD113EU	C46	EMH1	C50
DTA143ZEB	C38	DTC024XM	C44	DTC123YCA	C41	DTD113ZC	C46	EMH10	C50
DTA143ZKA	C42	DTC024XUB	C45	DTC123YE	C39	DTD113ZK	C46	EMH11	C50
DTA143ZM	C38	DTC043EEB	C44	DTC123YEB	C38	DTD113ZU	C46	EMH2	C50
DTA143ZU3	C41	DTC043EM	C44	DTC123YKA	C42	DTD114EC	C46	EMH25	C50
DTA143ZUA	C40	DTC043EUB	C45	DTC123YMA	C38	DTD114EK	C46	EMH3	C50
DTA143ZUB	C39	DTC043TEB	C44	DTC123YU3	C41	DTD114EU	C46	EMH4	C50
DTA144ECA	C41	DTC043TM	C44	DTC123YUA	C40	DTD114GC	C46	EMH51	C51
DTA144EE	C39	DTC043TUB	C45	DTC123YUB	C39	DTD114GK	C46	EMH52	C51
DTA144EEB	C38	DTC043XEB	C44	DTC124ECA	C41	DTD114GU	C46	EMH53	C51
DTA144EKA	C42	DTC043XM	C44	DTC124EE	C39	DTD123EC	C46	EMH59	C51
DTA144EM	C38	DTC043XUB	C45	DTC124EEB	C38	DTD123EK	C46	EMH60	C51
DTA144EU3	C41	DTC043ZEB	C44	DTC124EKA	C42	DTD123EU	C46	EMH61	C51
DTA144EUA	C40	DTC043ZM	C44	DTC124EM	C38	DTD123TC	C46	EMH75	C51
DTA144EUB	C39	DTC043ZUB	C45	DTC124EU3	C41	DTD123TK	C46	EMH9	C50
DTA144GUA	C40	DTC044EEB	C44	DTC124EUA	C40	DTD123TU	C46	EML22	C35
DTA144TCA	C41	DTC044EM	C44	DTC124EUB	C39	DTD123YC	C46	EMT1	C33
DTA144TUA	C40	DTC044EUB	C45	DTC124GUA	C40	DTD123YK	C46	EMT18	C33
DTA144VCA	C41	DTC044TEB	C44	DTC124TCA	C41	DTD123YU	C46	EMT51	C33
DTA144VMA	C38	DTC044TM	C44	DTC124TUA	C40	DTD143EC	C46	EMT52	C33
DTA144WCA	C41	DTC044TUB	C45	DTC124XCA	C41	DTD143EK	C46	EMX1	C33
DTA144WMA	C38	DTC113ZCA	C41	DTC124XE	C39	DTD143EU	C46	EMX18	C33
DTA144WUA	C40	DTC113ZE	C39	DTC124XEB	C38	DTD513ZE	C47	EMX26	C33
DTB113EC	C46	DTC113ZEB	C38	DTC124XKA	C42	DTD513ZM	C47	EMX51	C33
DTB113EK	C46	DTC113ZKA	C42	DTC124XMA	C38	DTD523YE	C47	EMX52	C33
DTB113EU	C46	DTC113ZMA	C38	DTC124XU3	C41	DTD523YM	C47	EMY1	C33
DTB113ZC	C46	DTC113ZU3	C41	DTC124XUA	C40	DTD543EE	C47	EMZ1	C33
DTB113ZK	C46	DTC113ZUA	C40	DTC124XUB	C39	DTD543EM	C47	EMZ51	C33

Part No. List

Part No.	Page	Part No.	Page	Part No.	Page	Part No.	Page	Part No.	Page
EMZ52	C33	KD2002-D3JX20A	F12	LA-401VD/VN	E19	MK71050-03	F7	ML610Q412P	A118
EMZ6.8E	C79	KD2002-D5JX20A	F12	LA-501MD/MN	E19	MK71251-01	F7	ML610Q418	A118
EMZ6.8N	C79	KD2002-DAFW00A	F14	LA-501VD/VN	E19	MK71251-02	F7	ML610Q418C	A118
EMZ7	C33	KD2002-DC72A	F15	LA-601AB/AL	E19	MK71251-02A	F7	ML610Q419	A118
EMZ8	C33	KD2002-DC92A	F15	LA-601EB/EL	E19	MK71251-02B	F7	ML610Q419C	A118
EMZT6.8E	C79	KD2002-DEFW00A	F14	LA-601MB/ML	E19	MK72750A-01	F7	ML610Q421	A116
ES6U1	C9	KD2003-CAFW00A	F13	LA-601VB/VL	E19	ML22321	A106	ML610Q421P	A116
ES6U2	C9	KD2003-CE22A	F13	LAP-301DB/DL	E18	ML22Q321	A106	ML610Q422	A116
ES6U3	C9	KD2003-CG11A	F13	LAP-301MB/ML	E18	ML22420	A107	ML610Q422P	A116
ES6U41	C9	KD2003-CG22A	F13	LAP-301VB/VL	E18	ML22460	A107	ML610Q426	A116
ES6U42	C9	KD2003-D0FW00A	F14	LAP-401DD/DN	E18	ML22562	A106	ML610Q426C	A116
ESR01	D8	KD2003-D3JX20A	F12	LAP-401MD/MN	E18	ML22563	A106	ML610Q428	A116
ESR03	D8	KD2003-D5FW00A	F14	LAP-401VD/VN	E18	ML22Q563	A106	ML610Q429	A116
ESR10	D8	KD2003-D5GW00A	F14	LAP-601DB/DL	E18	ML22572	A106	ML610Q431	A116
ESR18	D8	KD2003-D5JX20A	F12	LAP-601MB/ML	E18	ML22573	A106	ML610Q431A	A116
ESR25	D8	KD2003-DAFW00A	F14	LAP-601VB/VL	E18	ML22Q573	A106	ML610Q432	A116
FDZ Series	C76	KD2003-DC72A	F15	LB-402MD/MN	E19	ML22594	A107	ML610Q432A	A116
FMA1A	C52	KD2003-DC92A	F15	LB-402VD/VN	E19	ML22723	A106	ML610Q435	A116
FMA2A	C52	KD2003-DEFW00A	F14	LB-502MD/MN	E19	ML22724	A106	ML610Q435A	A116
FMA3A	C52	KD2003-DEGW00A	F14	LB-502VD/VN	E19	ML22725	A106	ML610Q436	A116
FMA4A	C52	KD2003-FOFW00A	F14	LB-602AA2/AK2	E19	ML22763	A106	ML610Q436A	A116
FMA5A	C52	KD2003-FOGW00A	F14	LB-602EA2/EK2	E19	ML22764	A106	ML610Q438	A116
FMA9A	C52	KD2003-F5FW00A	F14	LB-602MA2/MK2	E19	ML22765	A106	ML610Q439	A116
FMG1A	C52	KD2003-F5GW00A	F14	LB-602VA2/VK2	E19	ML22802	A106	ML610Q439P	A116
FMG2A	C52	KD2004-C1GW00A	F13	LB-603VF/VP	E19	ML22804	A106	ML610Q461	A118
FMG3A	C52	KD2004-CAFW00A	F13	LBP-602DA2/DK2	E18	ML22808	A106	ML610Q462	A118
FMG4A	C52	KD2004-CAGW00A	F13	LBP-602MA2/MK2	E18	ML22823	A106	ML610Q463	A118
FMG6A	C52	KD2004-CG11A	F13	LBP-602VA2/VK2	E18	ML22824	A106	ML610Q477	A118
FMG9A	C52	KD2004-D0GW00A	F14	LF-3011MA/MK	E18	ML22825	A106	ML610Q478	A118
FMY1A	C33	KD2004-D1GW00A	F14	LF-3011VA/VK	E18	ML22863	A106	ML610Q479	A118
FTZ30E	C79	KD2004-D5JX20A	F12	LM2901	A16	ML22864	A106	ML610Q482	A116
FTZ4.3E	C79	KD2004-DAFW00A	F14	LM2902	A10	ML22865	A106	ML610Q482P	A116
FTZ5.6E	C79	KD2004-DAGW00A	F14	LM2903	A16	ML22Q374	A106	ML610Q486P	A63
FTZ6.8E	C79	KD2004-DC72A	F15	LM2904	A10	ML22Q394	A106	ML610Q488P	A63
FTZU6.2E	C79	KD2004-DC92A	F15	LM324	A14	ML22Q553	A106	ML610Q793	A120
GDZ Series	C76	KD2004-DEFW00A	F14	LM339	A16	ML26700CGD	A89	ML610Q794G	A120
GMR100	D18	KD2006-DC72A	F15	LM358	A14	ML26700SGD	A89	ML620Q1xx	A114
GMR320	D18	KD2006-DC92A	F15	LM393	A16	ML5203	A63	ML620Q4xxA	A116
GMR50	D18	KD2008-CF10A	F13	LM4559	A15	ML5204	A63	ML620Q5xxH	A116
HP8K22	C14	KD2008-CF16A	F13	LM4565	A15	ML5232	A63	ML62Q12xxA	A110
HP8K24	C14	KD2008-CG50A	F13	LMR321	A14	ML5233	A63	ML62Q14xx	A110
HP8KA1	C14	KD3002-DC72A	F15	LMR324	A14	ML5235	A63	ML62Q15xx	A110
HP8M31	C14	KD3002-DC92A	F15	LMR341	A14	ML5236	A63	ML62Q16xx	A112
HP8M51	C14	KD3002-DF11A	F14	LMR342	A14	ML5238	A63	ML62Q17xx	A112
HP8MA2	C14	KD3003-DC72A	F15	LMR344	A14	ML5239	A63	ML630Q4xx	A116
HP8S36	C14	KD3003-DC92A	F15	LMR358	A14	ML5241	A63	ML630Q791	A120
HS8K1	C11	KD3003-DF11A	F14	LMR821	A14	ML5245	A63	ML7029	A94
HS8K11	C11	KD3003-KEFW00A	F14	LMR822	A14	ML5248	A63	ML7033-01	A94
HS8S2	C11	KD3003-LEGW00A	F13	LMR824	A14	ML610401	A118	ML7037-003	A93
HSM 100	F8	KD3004-DC72A	F15	LMR931	A13	ML610401P	A118	ML7041	A94
IMB10A	C50	KD3004-DC92A	F15	LMR932	A13	ML610402	A118	ML7066	A92
IMB11A	C50	KD3004-DF11A	F14	LMR934	A13	ML610402P	A118	ML7074-003	A93
IMB2A	C50	KD3004-K1GW00A	F14	LMR981	A13	ML610403	A118	ML7074-004	A93
IMB3A	C50	KD3006-DC72A	F15	LMR982	A13	ML610403P	A118	ML7105-002	A92
IMD10A	C53	KD3006-DC92A	F15	LTR10	D9, D14	ML610404	A118	ML7125-001	A92
IMD16A	C53	KD3008-CF10A	F13	LTR100	D9, D14	ML610404P	A118	ML7125-002	A92
IMD2A	C50	KD3008-DF54A	F14	LTR18	D9, D14	ML610405	A118	ML7147	A92
IMD3A	C50	KDZLV Series	C77	LTR50	D9, D14	ML610405P	A118	ML7154	A94
IMD6A	C50	KDZV Series	C77	MCR004	D4	ML610406	A118	ML7174	A94
IMD9A	C50	KMX62-1031	A90	MCR006	D4, D12	ML610406P	A118	ML7183	A94
IMH11A	C50	KR2002-D06N10A	F12	MCR01	D4, D12	ML610407	A118	ML7202-001	A93
IMH1A	C50	KTR03	D10	MCR03	D4, D12	ML610407P	A118	ML7204-003	A93
IMH21	C53	KTR10	D10	MCR10	D4, D12	ML610408	A118	ML7214A-001	A93
IMH23	C53	KTR18	D10	MCR100	D5, D12	ML610408P	A118	ML7224A-001	A93
IMH2A	C50	KTR25	D10	MCR18	D5, D12	ML610409	A118	ML7247-001	A93
IMH3A	C50	KX112-1042	A90	MCR25	D5, D12	ML610409P	A118	ML7275	A92
IMH4A	C50	KX122-1037	A90	MCR50	D5, D12	ML610421	A116	ML7344C	A92
IMH9A	C50	KX123-6000	A90	MD56V62160M	A3	ML610426	A116	ML7344J	A92
IMN10	C84	KX124-1051	A90	MD56V62161M	A3	ML610429	A116	ML7345	A92
IMT18	C33	KX126-1063	A90	MD56V62161M-xxTAL42X	A3	ML610482	A116	ML7345C	A92
IMT1A	C33	KX220 Series	A90	MD56V62161M-xxTALQ2X	A3	ML610482P	A116	ML7345D	A92
IMX1	C33	KX222-1054	A90	MD56V62161M-xxTAP	A3	ML610Q1xx	A114	ML7386	A92
IMX25	C33	KX224-1053	A90	MD56V72160C	A3	ML610Q3xx	A120	ML7386B	A92
IMZ1A	C33	KXCJB-1041	A90	MD56V72161C	A3	ML610Q407	A118	ML7396A	A92
KA2002-B35N00A	F12	KXG07	A90	MD56V72161C-xxTAL42X	A3	ML610Q407A	A118	ML7396D	A92
KA2002-BE13A	F12	KXG08	A90	MD56V72161C-xxTALQ2X	A3	ML610Q407D	A118	ML7404	A93
KA2002-D35N20A	F12	KXTC9 Series	A90	MD56V72161C-xxTAP	A3	ML610Q407P	A118	ML7406	A92
KA2002-FB20A	F12	KXTJ3-1057	A90	MD56V82161A	A3	ML610Q407PA	A118	ML7416N	A93
KA2003-B35N00A	F12	LA-101MA/MK	E19	MD56V82161A-xxTAL42X	A3	ML610Q408	A118	ML7630	A62
KA2003-BE51A	F12	LA-101VA/VK	E19	MD56V82161A-xxTALQ2X	A3	ML610Q408P	A118	ML7631	A62
KA2003-D35N20A	F12	LA-301AB/AL	E19	MD56V82161A-xxTAP	A3	ML610Q409	A118	ML8540	A90
KA2004-BE51A	F12	LA-301EB/EL	E19	MD60S1G160A-xxLAL43L	A3	ML610Q409A	A118	ML86101A	A103
KA2004-D35N90A	F12	LA-301MB/ML	E19	MD60S1G160A-xxLALQ3L	A3	ML610Q409P	A118	ML86173	A104
KA2008-AF10A	F12	LA-301VB/VL	E19	MD60S1G160A-xxLAZP	A3	ML610Q411	A118	ML86203	A104
KA3002-B05N00A	F12	LA-401AD/AN	E19	MD60Y1G160A-xxLAL43L	A3	ML610Q411P	A118	ML86207	A104
KD2002-CAFW00A	F13	LA-401ED/EN	E19	MD60Y1G160A-xxLALQ3L	A3	ML610Q411PA	A118	ML86209	A104
KD2002-CG11A	F13	LA-401MD/MN	E19	MD60Y1G160A-xxLAZP	A3	ML610Q412	A118	ML86240	A104

Part No.	Page	Part No.	Page	Part No.	Page	Part No.	Page	Part No.	Page
ML86241	A104	MR44V064A	A7	QS5U36	C9	R6011KNJ	C19	R6515ENZ	C18
ML86287	A104	MR44V064B	A7	QS5W1	C36	R6011KNX	C19	R6515KNJ	C19
ML86289	A104	MR44V100A	A7	QS5W2	C36	R6012JNJ	C20	R6515KNX	C19
ML86640	A103	MR45V032A	A7	QS5Y1	C36	R6012JNX	C20	R6515KNX1	C19
ML86790	A103	MR45V064B	A7	QS5Y2	C36	R6015ENJ	C18	R6515KNZ	C19
ML86795	A103	MR45V100A	A7	QS6J11	C7	R6015ENX	C18	R6520ENJ	C18
ML86V7655	A103	MR45V200A	A7	QS6K1	C7, C21	R6015ENZ	C18	R6520ENX	C18
ML86V76580	A103	MR45V256A	A7	QS6K21	C21	R6015KNJ	C19	R6520ENZ	C18
ML86V7668A	A103	MR48V256C	A7	QS6M4	C7	R6015KNX	C19	R6520ENZ1	C18
ML86V7675	A103	MS81V26000	A4	QS6U22	C9	R6015KNZ	C19	R6520KNJ	C19
ML86V8101	A104	MS81V26000-25TPZP3	A4	QS6U24	C9	R6018JNJ	C20	R6520KNX	C19
ML86V8102	A104	MSL0104RGBU	E8	QS6Z5	C36	R6018JNX	C20	R6520KNX1	C19
ML86V8201	A104	MSL0104RGBW	E8	QS8J12	C8	R6020ENJ	C18	R6520KNZ	C19
ML86V8202C	A104	MSL0402RGBU	E8	QS8J13	C8	R6020ENX	C18	R6520KNZ1	C19
ML86V8207	A104	MSL0501RGBW	E8	QS8J2	C8	R6020ENZ	C18	R6524ENJ	C18
ML86V8401	A104	MSL0502RGBW	E8	QS8J4	C8, C21	R6020ENZ1	C18	R6524ENX	C18
ML9042-0x	A85	MSL0601RGBU	E8	QS8J5	C8	R6020JNJ	C20	R6524ENZ	C18
ML9042-1x	A85	MSM56V16160N	A3	QS8K11	C8	R6020JNX	C20	R6524ENZ1	C18
ML9042-2x	A85	MSM56V16160NP	A3	QS8K13	C8	R6020JNZ	C20	R6524KNJ	C19
ML9058E	A85	MSM56V16161N	A3	QS8K2	C21	R6020JNZ1	C20	R6524KNX	C19
ML9059E	A85	MSM56V16161NP	A3	QS8K21	C8	R6020KNJ	C19	R6524KNX1	C19
ML9092-01	A85	MSM56V16161NP-xxTFEL	A3	QS8M13	C8	R6020KNX	C19	R6524KNZ	C19
ML9092-02	A85	MSM7533V	A94	QS8M31	C8	R6020KNZ	C19	R6524KNZ1	C19
ML9092-03	A85	MSM7578V	A94	QS8M51	C8, C21	R6020KNZ1	C19	R6530ENX	C18
ML9092-04	A85	MSM7704-01	A94	QSH29	C53	R6020PNJ	C23	R6530ENZ	C18
ML9098B	A86	MSM7717-01	A94	QST2	C29	R6024ENJ	C18	R6530ENZ1	C18
ML9208-xxGA	A86	MSM7732A	A94	QST3	C29	R6024ENX	C18	R6530KNX	C19
ML9208-xxMB	A86	MSM9563	A94	QST8	C36	R6024ENZ	C18	R6530KNX1	C19
ML9208A-xxGA	A86	PDZVB Series	C77	QST9	C36	R6024ENZ1	C18	R6530KNZ	C19
ML9208A-xxTB	A86	PML10	D16	QSX1	C29	R6024KNJ	C19	R6530KNZ1	C19
ML9209-xxGA	A86	PML100	D16	QSX2	C29	R6024KNX	C19	R6535ENZ	C18
ML9212GA	A86	PML18	D16	QSX7	C36	R6024KNZ	C19	R6535ENZ1	C18
ML9213GP	A86	PML50	D16	QSX8	C36	R6024KNZ1	C19	R6535KNX1	C19
ML9271	A86	PMR01	D15	QSZ2	C36	R6025JNX	C20	R6535KNZ	C19
ML9272	A86	PMR03	D15	QSZ4	C36	R6025JNZ	C20	R6535KNZ1	C19
ML9286-xxGA	A86	PMR10	D15	R5205PND3	C23	R6025JNZ1	C20	R6547ENZ1	C18
ML9286-xxTB	A86	PMR100	D15	R6002END3	C18	R6030ENX	C18	R6547KNZ1	C19
ML9289-xxGA	A86	PMR18	D15	R6003KND3	C19	R6030ENZ	C18	R6576ENZ1	C18
ML9289-xxTB	A86	PMR25	D15	R6004END3	C18	R6030ENZ1	C18	R6576KNZ1	C19
ML9298	A86	PMR50	D15	R6004ENJ	C18	R6030JNZ	C20	R8001CND3	C23
ML9445	A85	PSR100	D17	R6004ENX	C18	R6030JNZ1	C20	R8002ANJ	C23
ML9460	A85	PSR400	D17	R6004JND3	C20	R6030KNX	C19	R8002ANX	C19
ML9461B	A85	PSR500	D17	R6004JNJ	C20	R6030KNZ	C19	R8002CND3	C23
ML9470-12	A86	PTM 210	F8	R6004JNX	C20	R6030KNZ1	C19	R8005ANJ	C23
ML9471	A86	PTM 210J	F8	R6004KNJ	C19	R6030KNZ	C19	R8005ANX	C19
ML9472	A86	PTM 330	F8	R6004KNX	C19	R6030MNZ	C20	R8008ANJ	C23
ML9473	A86	PTM 430J	F8	R6004PND3	C23	R6030MNZ1	C20	R8008ANX	C19
ML9475	A86	PV3012	A53	R6005JND3	C20	R6035ENZ	C18	R8010ANX	C19
ML9476	A86	PV3101	A53	R6005JNJ	C20	R6035ENZ1	C18	RAF040P01	C6
ML9477	A86	PV3102	A53	R6005JNX	C20	R6035KNZ	C19	RAL025P01	C6
ML9478C	A86	PV3103	A53	R6006JND3	C20	R6035KNZ1	C19	RAL035P01	C6
ML9479E	A86	PV3104	A53	R6006JNJ	C20	R6042JNZ1	C20	RAL045P01	C6
ML9480	A86	PV3105	A53	R6006JNX	C20	R6047ENZ1	C18	RB021VAM90	C63
ML9484	A86	PV3114	A53	R6006KND3	C19	R6047KNZ1	C19	RB050LAM-30	C67
ML9488	A86	PV3201	A53	R6006KNX	C19	R6047MNZ	C20	RB050LAM-40	C67
ML9489	A86	PV3202	A53	R6006PND3	C23	R6047MNZ1	C20	RB050LAM-60	C67
ML9860B	A84	PV3203	A53	R6007END3	C18	R6070JNZ1	C20	RB051LAM-40	C67
ML9863A	A84	PV3204	A53	R6007ENJ	C18	R6076ENZ1	C18	RB051MM-2Y	C67
ML9872	A84	PV3205	A53	R6007ENX	C18	R6076KNZ1	C19	RB055LAM-30	C67
ML9873	A84	PV3207	A53	R6007JND3	C20	R6076MNZ1	C20	RB055LAM-40	C67
ML9881	A84	PV4110	A53	R6007JNJ	C20	R6502END3	C18	RB055LAM-60	C67
ML9882	A84	PV4210	A53	R6007JNX	C20	R6504END3	C18	RB056LAM-40	C67
ML9883	A84	QH6J1	C7	R6007KND3	C19	R6504ENJ	C18	RB058LAM-30	C67
MMBZ10VAL	C81	QH6K21	C7	R6007KNJ	C19	R6504ENX	C18	RB058LAM-40	C67
MMBZ12VAL	C81	QH8JA1	C8	R6007KNX	C19	R6504KND3	C19	RB058LAM-60	C67
MMBZ15VAL	C81	QH8K22	C8	R6007MND3	C20	R6504KNJ	C19	RB058LAM100	C67
MMBZ16VAL	C81	QH8K26	C8	R6007MNJ	C20	R6504KNX	C19	RB058LAM150	C67
MMBZ18VAL	C81	QH8K51	C8	R6007MNX	C20	R6507END3	C18	RB060LAM-40	C67
MMBZ20VAL	C81	QH8KA1	C8	R6008MND3	C20	R6507ENJ	C18	RB060MM-30	C67
MMBZ24VAL	C81	QH8KA2	C8	R6008MNJ	C20	R6507ENX	C18	RB060MM-40	C67
MMBZ27VAL	C81	QH8KA4	C8	R6008MNX	C20	R6507KND3	C19	RB060MM-60	C67
MMBZ27VCL	C81	QH8M22	C8	R6009END3	C18	R6507KNJ	C19	RB061QS-20	C62
MMBZ30VAL	C81	QH8MA2	C8	R6009ENJ	C18	R6507KNX	C19	RB061US-30	C64
MMBZ33VAL	C81	QH8MA3	C8	R6009ENX	C18	R6509END3	C18	RB068LAM-30	C67
MMBZ5V6AL	C81	QH8MA4	C8	R6009JND3	C20	R6509ENJ	C18	RB068LAM-40	C67
MMBZ6V2AL	C81	QS5K2	C7	R6009JNJ	C20	R6509ENX	C18	RB068LAM-60	C67
MMBZ6V8AL	C81	QS5U12	C9	R6009JNX	C20	R6509KND3	C19	RB068LAM100	C67
MMBZ9V1AL	C81	QS5U13	C9	R6009KND3	C19	R6509KNJ	C19	RB068LAM150	C67
MNR02	D6	QS5U16	C9	R6009KNJ	C19	R6509KNX	C19	RB068MM-30	C67
MNR04	D6	QS5U17	C9	R6009KNX	C19	R6511END3	C18	RB068MM-40	C67
MNR12	D6	QS5U21	C9	R6010MND3	C20	R6511ENJ	C18	RB068MM-60	C67
MNR14	D6	QS5U23	C9	R6010MNJ	C20	R6511ENX	C18	RB068MM100	C67
MNR15	D7	QS5U26	C9	R6010MNX	C20	R6511KND3	C19	RB070MM-30	C67
MNR18	D7	QS5U27	C9	R6011END3	C18	R6511KNJ	C19	RB075BM40S	C70
MNR32	D6	QS5U28	C9	R6011ENJ	C18	R6511KNX	C19	RB078BM30S	C70
MNR34	D6	QS5U33	C9	R6011ENX	C18	R6515ENJ	C18	RB080LAM-30	C67
MNR35	D7	QS5U34	C9	R6011KND3	C19	R6515ENX	C18	RB081LAM-20	C67

Part No. List

Part No.	Page	Part No.	Page	Part No.	Page	Part No.	Page	Part No.	Page
RB085BM-30	C70	RB218NS-60	C70	RB521CS-30	C62	RBQ15BM65A	C69	RBS3LAM40C	C66
RB085BM-40	C70	RB218NS100	C70	RB521G-30	C62	RBQ20BM45A	C69	RBS3MM40A	C66
RB085BM-60	C70	RB218NS150	C70	RB521G-40	C62	RBQ20BM65A	C69	RBS3MM40B	C66
RB085BM-90	C70	RB218T-30	C70	RB521SM-30	C62	RBQ20NS45A	C69	RBS5LAM40A	C66
RB085T-40	C70	RB218T-40	C70	RB521SM-40	C62	RBQ20NS65A	C69	RCJ050N25	C17
RB085T-60	C70	RB218T-60	C70	RB521SM-60	C62	RBQ20T45A	C69	RCJ081N20	C17
RB085T-90	C70	RB218T100	C70	RB521VM-30	C63	RBQ20T65A	C69	RCJ100N25	C17
RB088BM-30	C70	RB218T150	C70	RB521VM-40	C63	RBQ30NS45A	C69	RCJ120N20	C17
RB088BM-40	C70	RB225NS-40	C70	RB521ZS-30	C62	RBQ30NS45B	C69	RCJ120N25	C17
RB088BM-60	C70	RB225T-40	C70	RB521ZS-40	C62	RBQ30NS65A	C69	RCJ160N20	C17
RB088BM100	C70	RB225T-60	C70	RB522ES-30	C62	RBQ30T45A	C69	RCJ200N20	C17
RB088BM150	C70	RB228NS-30	C70	RB522FS-30	C62	RBQ30T65A	C69	RCJ220N25	C17
RB088LAM-30	C67	RB228NS-40	C70	RB530CM-30	C62	RBQ30TB45B	C69	RCJ300N20	C17
RB088LAM-40	C67	RB228NS-60	C70	RB530CM-40	C62	RBR10BM30A	C69	RCJ330N25	C17
RB088LAM-60	C67	RB228NS100	C70	RB530CM-60	C62	RBR10BM40A	C69	RCJ450N20	C17
RB088LAM100	C67	RB228NS150	C70	RB530SM-30	C62	RBR10BM60A	C69	RCJ510N25	C17
RB088LAM150	C67	RB228T-30	C70	RB530SM-40	C62	RBR10NS30A	C69	RCJ700N20	C17
RB088NS-30	C70	RB228T-40	C70	RB530VM-30	C63	RBR10NS40A	C69	RCX051N25	C16
RB088NS-40	C70	RB228T-60	C70	RB530VM-40	C63	RBR10NS60A	C69	RCX080N25	C16
RB088NS-60	C70	RB228T100	C70	RB530XN	C64	RBR10T30A	C69	RCX081N20	C16
RB088NS100	C70	RB228T150	C70	RB531CM-30	C62	RBR10T40A	C69	RCX100N25	C16
RB088NS150	C70	RB238NS-30	C70	RB531CM-40	C62	RBR10T60A	C69	RCX120N20	C16
RB088T-30	C70	RB238NS-40	C70	RB531ES-30	C62	RBR15BM30A	C69	RCX120N25	C16
RB088T-40	C70	RB238NS-60	C70	RB531SM-30	C62	RBR15BM40A	C69	RCX160N20	C16
RB088T-60	C70	RB238NS100	C70	RB531SM-40	C62	RBR15BM60A	C69	RCX200N20	C16
RB088T100	C70	RB238NS150	C70	RB531VM-30	C63	RBR1LAM30A	C66	RCX220N25	C16
RB088T150	C70	RB238T-30	C70	RB531VM-40	C63	RBR1LAM40A	C66	RCX300N20	C16
RB095BM-30	C70	RB238T-40	C70	RB531XN	C64	RBR1LAM60A	C66	RCX330N25	C16
RB095BM-40	C70	RB238T-60	C70	RB540SM-40	C62	RBR1MM30A	C66	RCX450N20	C16
RB095BM-60	C70	RB238T100	C70	RB540VM-30	C63	RBR1MM40A	C66	RCX511N25	C16
RB095BM-90	C70	RB238T150	C70	RB540VM-40	C63	RBR1MM60A	C66	RCX700N20	C16
RB095T-40	C70	RB298NS100	C70	RB541SM-40	C62	RBR20BM30A	C69	RD3G400GN	C16
RB095T-60	C70	RB298T100	C70	RB541VM-30	C63	RBR20BM40A	C69	RD3G500GN	C16
RB095T-90	C70	RB400D	C64	RB541VM-40	C63	RBR20BM60A	C69	RD3G600GN	C16
RB098BM-30	C70	RB400VAM-50	C63	RB541XN	C64	RBR20NS30A	C69	RD3H045SP	C16, C23
RB098BM-40	C70	RB400VYM-50	C63	RB548WWM	C64	RBR20NS40A	C69	RD3H080SP	C16, C23
RB098BM-60	C70	RB411D	C64	RB550EA	C64	RBR20NS60A	C69	RD3H160SP	C16, C23
RB098BM100	C70	RB411VAM-50	C63	RB550VAM-30	C63	RBR20T30A	C69	RD3H200SN	C16, C23
RB098BM150	C70	RB420D	C64	RB550VM-30	C63	RBR20T40A	C69	RD3L050SN	C16, C23
RB160LAM-40	C67	RB421D	C64	RB550VM-40	C63	RBR20T60A	C69	RD3L06BGN	C16
RB160LAM-90	C67	RB425D	C64	RB550VVM-30	C63	RBR2LAM30A	C66	RD3L080SN	C16, C23
RB160MM-30	C67	RB450UM	C64	RB551VM-30	C62	RBR2LAM40A	C66	RD3L08BGN	C16
RB160MM-40	C67	RB451UM	C64	RB551VM-40	C63	RBR2LAM60A	C66	RD3L08CGN	C16
RB160MM-50	C67	RB461F	C64	RB552EA	C64	RBR2LAM60B	C66	RD3L140SP	C16, C23
RB160MM-60	C67	RB471E	C64	RB557WWM	C64	RBR2MM30A	C66	RD3L150SN	C16, C23
RB160MM-90	C67	RB480K	C64	RB558VAM150	C63	RBR2MM30B	C66	RD3L220SN	C16, C23
RB160VAM-40	C63	RB480Y	C64	RB558VVM150	C63	RBR2MM40A	C66	RD3P050SN	C16, C23
RB160VAM-60	C63	RB480Y-40	C64	RB558WWM	C64	RBR2MM40B	C66	RD3P08BBD	C16
RB160VYM-40	C63	RB480Y-90	C64	RB560VM-40	C63	RBR2MM40C	C66	RD3P100SN	C16, C23
RB160VYM-60	C63	RB481K	C64	RB561VM-40	C63	RBR2MM60A	C66	RD3P130SP	C16, C23
RB161MM-20	C67	RB481Y	C64	RB578VAM100	C63	RBR2MM60B	C66	RD3P175SN	C16, C23
RB161QS-40	C62	RB481Y-40	C64	RB578VVM100	C63	RBR2MM60C	C66	RD3P200SN	C16, C23
RB161VAM-20	C63	RB481Y-90	C64	RB705D	C64	RBR30NS30A	C69	RD3S075CN	C16
RB162LAM-40	C67	RB491D	C64	RB706D-40	C64	RBR30NS40A	C69	RD3S100CN	C16
RB162LAM-60	C67	RB495D	C64	RB706UM-40	C64	RBR30NS60A	C69	RD3T050CN	C16
RB162MM-30	C67	RB496EA	C64	RB706WWM-40	C64	RBR30T30A	C69	RD3T075CN	C16
RB162MM-40	C67	RB496KA	C64	RB715UM	C64	RBR30T40A	C69	RD3T100CN	C16
RB162MM-60	C67	RB500SM-30	C62	RB715WWM	C64	RBR30T60A	C69	RD3U040CN	C16
RB162VAM-20	C63	RB500VM-40	C63	RB715Z	C64	RBR3LAM30A	C66	RD3U041AA	C23
RB168LAM-30	C67	RB501SM-30	C62	RB717UM	C64	RBR3LAM30B	C66	RD3U060CN	C16
RB168LAM-40	C67	RB501VM-40	C63	RB731U	C64	RBR3LAM40A	C66	RD3U080AA	C23
RB168LAM-60	C67	RB510SM-30	C62	RB731XN	C64	RBR3LAM40B	C66	RD3U080CN	C16
RB168LAM100	C67	RB510SM-40	C62	RB751CM-40	C62	RBR3LAM40C	C66	RE1C001UN	C3
RB168LAM150	C67	RB510VM-30	C63	RB751CS-40	C62	RBR3LAM60A	C66	RE1C001ZP	C3
RB168MM-30	C67	RB510VM-40	C63	RB751G-40	C62	RBR3LAM60B	C66	RE1C002UN	C3
RB168MM-40	C67	RB511SM-30	C62	RB751SM-40	C62	RBR3MM30A	C66	RE1C002ZP	C3
RB168MM-60	C67	RB511SM-40	C62	RB751VM-40	C63	RBR3MM40A	C66	RE1E002SP	C3
RB168MM100	C67	RB511VM-30	C63	RB751ZS-40	C62	RBR3MM40B	C66	RE1J002YN	C3
RB168MM150	C67	RB511VM-40	C63	RB851Y	C85	RBR3MM60A	C66	RE1L002SN	C3
RB168VAM-30	C63	RB520AS-30	C62	RB861Y	C85	RBR3MM60B	C66	RESD1CAN	C81
RB168VAM-40	C63	RB520AS-40	C62	RB886CM	C85	RBR40NS30A	C69	RF01VM2S	C71
RB168VAM-60	C63	RB520CM-30	C62	RB886Y	C85	RBR40NS40A	C69	RF04UA2D	C71
RB168VAM100	C63	RB520CM-40	C62	RBE05AS20A	C62	RBR40NS60A	C69	RF05VAM1S	C71
RB168VAM150	C64	RB520CM-60	C62	RBE05SM20A	C62	RBR5LAM30A	C66	RF05VAM2S	C71
RB168VYM-30	C63	RB520CS-30	C62	RBE05VM20A	C62	RBR5LAM30B	C66	RF05VYM1S	C71
RB168VYM-40	C63	RB520G-30	C62	RBE07V20A	C62	RBR5LAM40A	C66	RF05VYM2S	C71
RB168VYM-60	C63	RB520G-40	C62	RBE1KA20A	C64	RBR5LAM60A	C66	RF071LAM4S	C71
RB168VYM100	C63	RB520SM-30	C62	RBE1VAM20A	C63	RBS1LAM40A	C66	RF071MM2S	C71
RB168VYM150	C64	RB520SM-40	C62	RBE2EA20A	C64	RBS1MM40A	C66	RF081LAM2S	C71
RB205T-40	C70	RB520VM-30	C63	RBE2VAM20A	C63	RBS2LAM40A	C66	RF081MM2S	C71
RB205T-60	C70	RB520VM-40	C63	RBQ10BM45A	C69	RBS2LAM40B	C66	RF1001NS2D	C73
RB205T-90	C70	RB520ZS-30	C62	RBQ10BM65A	C69	RBS2LAM40C	C66	RF1001T2D	C73
RB215T-40	C70	RB520ZS-40	C62	RBQ10NS45A	C69	RBS2MM40A	C66	RF1005TF6S	C74
RB215T-60	C70	RB521AS-30	C62	RBQ10NS65A	C69	RBS2MM40B	C66	RF101LAM2S	C71
RB215T-90	C70	RB521AS-40	C62	RBQ10T45A	C69	RBS2MM40C	C66	RF101LAM4S	C71
RB218NS-30	C70	RB521CM-30	C62	RBQ10T65A	C69	RBS3LAM40A	C66	RF1501TF3S	C74
RB218NS-40	C70	RB521CM-40	C62	RBQ15BM45A	C69	RBS3LAM40B	C66	RF1601NS2D	C73

Part No. List

Part No.	Page	Part No.	Page	Part No.	Page	Part No.	Page	Part No.	Page
RF1601T2D	C73	RFUH30TS6D	C73	RJ1L12BGN	C17	RQ3E150BN	C11	RRE04EA4D	C75
RF2001NS2D	C73	RFUH30TS6S	C73	RJ1L12CGN	C17	RQ3E150GN	C11	RRE04EA6D	C75
RF2001NS3D	C73	RFUH5TF6S	C74	RJ1L12DGN	C17	RQ3E160AD	C11	RRE07VSM4S	C75
RF2001T2D	C73	RFUH60TS6D	C73	RJ1P12BBD	C17	RQ3E180AJ	C11	RRE07VSM6S	C75
RF2001T3D	C73	RFV12TG6S	C74	RJ1U330AA	C23	RQ3E180BN	C11	RRE07VTM4S	C75
RF201LAM2S	C71	RFV12TJ6S	C74	RJP020N06	C11, C22	RQ3E180GN	C11	RRE07VTM6S	C75
RF201LAM4S	C71	RFV15TG6S	C74	RK7002BM	C3, C21	RQ3G100GN	C11	RRF015P03	C6
RF202LAM2S	C71	RFV15TJ6S	C74	RLD2WMNL2-00x	E22	RQ3G150GN	C11	RRH040P03	C13
RF301BM2S	C73	RFV30TG6S	C74	RLD2WMNL2-01x	E22	RQ3L050GN	C11	RRH050P03	C13
RF302LAM2S	C71	RFV5BM6S	C73	RLD63NPC5	E22	RQ3L090GN	C11	RRH090P03	C13
RF305BM6S	C73	RFV8BM6S	C73	RLD63NPC6	E22	RQ5A020ZP	C7	RRH100P03	C13
RF4C050AP	C11	RFV8TG6S	C74	RLD63NPC7	E22	RQ5A025ZP	C7	RRH140P03	C13
RF4C100BC	C11	RFV8TJ6S	C74	RLD63NPC8	E22	RQ5A030AP	C7	RRL025P03	C6, C21
RF4E060AJ	C11	RFVS8TG6S	C74	RLD63NC5	E22	RQ5A040ZP	C7	RRL035P03	C6, C21
RF4E070BN	C11	RFVS8TJ6S	C74	RLD65MQX1	E22	RQ5C020TP	C7	RRQ020P03	C7
RF4E070GN	C11	RGCL60TK60	B11	RLD65MZT7	E22	RQ5C025TP	C7	RRQ030P03	C21
RF4E075AT	C11	RGCL60TK60D	B11	RLD65NZX1	E22	RQ5C030TP	C7	RRQ045P03	C21
RF4E080BN	C11	RGCL60TS60	B11	RLD65NZX2	E22	RQ5C035BC	C7	RRR030P03	C21
RF4E080GN	C11	RGCL60TS60D	B11	RLD65NZX3	E22	RQ5C060BC	C7	RRR040P03	C21
RF4E100AJ	C11	RGCL80TK60	B11	RLD65PZX2	E22	RQ5E015RP	C7	RRS040P03	C22
RF4E110BN	C11	RGCL80TK60D	B11	RLD65PZX3	E22	RQ5E020SP	C7	RRS050P03	C22
RF4E110GN	C11	RGCL80TS60	B11	RLD78MZA6	E23	RQ5E025AT	C7	RRS075P03	C22
RF4L055GN	C11	RGCL80TS60D	B11	RLD78MZM7	E23	RQ5E025SN	C7	RRS090P03	C22
RF501BM2S	C73	RGPR10BM40FH	B12	RLD78NZM5	E23	RQ5E025SP	C7	RRS100P03	C22
RF505BM6S	C73	RGPR20BM36HR	B12	RLD78NZM7	E23	RQ5E025TN	C7	RRS140P03	C22
RF505TF6S	C74	RGPR20NS43HR	B12	RLD78PZM7	E23	RQ5E030AJ	C7	RRU1LAM4S	C75
RF5E050AJ	C6	RGPR30BM40HR	B12	RLD82NZJ1	E23	RQ5E030RP	C7	RS1E130GN	C14
RF601BM2D	C73	RGPR30BM56HR	B12	RLD82PZJ1	E23	RQ5E035AT	C7	RS1E150GN	C14
RF601T2D	C73	RGPR30NS40HR	B12	RLD84NZJ2	E23	RQ5E035BN	C7	RS1E170GN	C14
RF6C055BC	C6	RGPR50NS45HR	B12	RLD84PZJ2	E23	RQ5E035XN	C7	RS1E180BN	C14
RF6E045AJ	C6	RGPPZ10BM40FH	B12	RLD85NZJ4	E23	RQ5E040AJ	C7	RS1E200BN	C14
RF6E065BN	C6	RGPPZ30BM56HR	B12	RLD85PZJ4	E23	RQ5E040RP	C7	RS1E200GN	C14
RFC02MM2S	C71	RGS00TS65DHR	B11	RLD94NZJ5	E23	RQ5E040TN	C7	RS1E220AT	C14
RFN10BM3S	C73	RGS00TS65EHR	B11	RLD94NZJ7	E23	RQ5E050AT	C7	RS1E240BN	C14
RFN10BM6S	C73	RGS60TS65DHR	B11	RLD94PZJ5	E23	RQ5E065AJ	C7	RS1E240GN	C14
RFN10NS3S	C73	RGS80TS65DHR	B11	RLD94PZJ7	E23	RQ5E070BN	C7	RS1E260AT	C14
RFN10NS4S	C73	RGTO0TS65D	B11	RN141CM	C85	RQ5H020SP	C7	RS1E280BN	C14
RFN10NS6S	C73	RG116BM65D	B11	RN142SM	C85	RQ5H020TN	C7	RS1E280GN	C14
RFN10NS8D	C73	RG116NL65D	B11	RN142ZS	C85	RQ5H025TN	C7	RS1E300GN	C14
RFN10T2D	C73	RG116NS65D	B11	RN242CS	C85	RQ5H030TN	C7	RS1E320GN	C14
RFN10TB4S	C74	RG116TM65D	B11	RN262CS	C85	RQ5L015SP	C7	RS1E350BN	C14
RFN10TF6S	C74	RG130NL65D	B11	RN731V	C85	RQ5L020SN	C7	RS1E350GN	C14
RFN16T2D	C73	RG130NS65D	B11	RN739F	C85	RQ5L030SN	C7	RS1G120MN	C14
RFN1LAM6S	C71	RG130TM65D	B11	RN771V	C85	RQ5L035GN	C7	RS1G150MN	C14
RFN1LAM7S	C71	RG140NL65D	B11	RN779D	C85	RQ5P010SN	C7	RS1G180MN	C14
RFN20NS3S	C73	RG140NS65D	B11	RN779F	C85	RQ6A045AP	C7	RS1G260MN	C14
RFN20NS4S	C73	RG140TM65D	B11	RPI-0125	E28	RQ6A045ZP	C7	RS1G300GN	C14
RFN20NS6S	C73	RG140TS65D	B11	RPI-0226	E28	RQ6A050ZP	C7	RS1L120GN	C14
RFN20T2D	C73	RG150NL65D	B11	RPI-0352E	E28	RQ6C050BC	C7	RS1L145GN	C14
RFN20TB4S	C74	RG150NS65D	B11	RPI-121	E28	RQ6C050UN	C7	RS1L180GN	C14
RFN20TF6S	C74	RG150TM65D	B11	RPI-122	E28	RQ6C065BC	C7	RS1P600BE	C14
RFN20TJ6S	C74	RG150TS65D	B11	RPI-125	E28	RQ6E030AT	C7	RS3E075AT	C13
RFN2LAM4S	C71	RG160TS65D	B11	RPI-221	E28	RQ6E030SP	C7	RS3E095BN	C13
RFN2LAM6S	C71	RG180TS65D	B11	RPI-222	E28	RQ6E035AT	C7	RS3E130AT	C13
RFN30TS6D	C73	RG188M65D	B11	RPI-243	E28	RQ6E035SP	C7	RS3E135BN	C13
RFN30TS6S	C73	RG18NL65D	B11	RPI-246	E28	RQ6E035TN	C7	RS3E180AT	C13
RFN3BM2S	C73	RG18NS65D	B11	RPI-352	E28	RQ6E040XN	C7	RS3L045GN	C13
RFN3BM6S	C73	RGTH00TK65	B11	RPI-441C1	E28	RQ6E045BN	C7	RS3L140GN	C13
RFN5BM2S	C73	RGTH00TK65D	B11	RPI-441C1E	E28	RQ6E045RP	C7	RSA6.1EN	C79
RFN5BM3S	C73	RGTH00TS65	B11	RPM-20PB	E31	RQ6E045SN	C7	RSA6.1J4	C79
RFN5BM6S	C73	RGTH00TS65D	B11	RPM-22PB	E31	RQ6E045TN	C7	RSA6.1U5	C79
RFN5TF6S	C74	RGTH40TK65	B11	RPR-0521RS	E31	RQ6E050AJ	C7	RSAC16CM	C79
RFN5TF8S	C74	RGTH40TK65D	B11	RPT-34PB3F	E31	RQ6E050AT	C7	RSAC18CS	C79
RFN60TS6D	C73	RGTH40TS65	B11	RPT-37PB3F	E31	RQ6E055BN	C7	RSAC6.8CM	C79
RFN6BM2D	C73	RGTH40TS65D	B11	RPT-38PB3F	E31	RQ6E060AT	C7	RSB12JS2	C79
RFN6T2D	C73	RGTH50TK65	B11	RQ1A060ZP	C8	RQ6E080AJ	C7	RSB12V	C80
RFNL10TJ6S	C74	RGTH50TK65D	B11	RQ1A070AP	C8	RQ6E085BN	C7	RSB12WM	C80
RFNL15TJ6S	C74	RGTH50TS65	B11	RQ1A070ZP	C21	RQ6P015SP	C7	RSB16F2	C80
RFNL20TJ6S	C74	RGTH50TS65D	B11	RQ1C065UN	C8	RQ7E055AT	C8	RSB16V	C80
RFNL5BM6S	C73	RGTH60TK65	B11	RQ1C075UN	C8, C21	RQ7E100AT	C8	RSB16VA	C80
RFNL5TJ6S	C74	RGTH60TK65D	B11	RQ1E050RP	C8, C21	RQ7E110AJ	C8	RSB16X3N	C80
RFU01SM4S	C71	RGTH60TS65	B11	RQ1E070RP	C8, C21	RR1LAM4S	C75	RSB18UM2	C80
RFU02VSM6S	C71	RGTH60TS65D	B11	RQ1E075XN	C8	RR1LAM6S	C75	RSB18V	C80
RFU02VSM8S	C71	RGTH80TK65	B11	RQ1E100XN	C8	RR1VWM4S	C75	RSB18VA	C80
RFUH10NS4S	C73	RGTH80TK65D	B11	RQ3C150BC	C11	RR1VWM6S	C75	RSB27UM2	C80
RFUH10NS6S	C73	RGTH80TS65	B11	RQ3E070BN	C11	RR264MM-400	C75	RSB27V	C80
RFUH10TB4S	C74	RGTH80TS65D	B11	RQ3E075AT	C11	RR268MM-600	C75	RSB27VA	C80
RFUH10TF6S	C74	RGTV00TS65	B11	RQ3E080BN	C11	RR274EA-400	C75	RSB33F2	C80
RFUH20NS3S	C73	RGTV00TS65D	B11	RQ3E080GN	C11	RR2LAM4S	C75	RSB33V	C80
RFUH20NS4S	C73	RGTV60TS65	B11	RQ3E100AT	C11	RR2LAM6S	C75	RSB36F2	C80
RFUH20NS6S	C73	RGTV60TS65D	B11	RQ3E100BN	C11	RR601BM4S	C75	RSB36V	C80
RFUH20TB3S	C74	RGTVX6TS65	B11	RQ3E100GN	C11	RRD07MM4S	C75	RSB39F2	C80
RFUH20TB4S	C74	RHP020N06	C11, C22	RQ3E110AJ	C11	RRD20TJ10S	C75	RSB39V	C80
RFUH20TF6S	C74	RHP030N03	C11, C22	RQ3E120AT	C11	RRE02VSM4S	C75	RSB5.6SM	C80
RFUH20TJ6S	C74	RJ1G08CGN	C17	RQ3E120BN	C11	RRE02VSM6S	C75	RSB6.8CM	C80
RFUH25NS3S	C73	RJ1G12BGN	C17	RQ3E120GN	C11	RRE02VTM4S	C75	RSB6.8CS	C80
RFUH25TB3S	C74	RJ1L08CGN	C17	RQ3E130BN	C11	RRE02VTM6S	C75	RSB6.8F2	C80

Part No. List

Part No.	Page	Part No.	Page	Part No.	Page	Part No.	Page	Part No.	Page
RSB6.8SM	C80	RU1C002UN	C3	SCS212AGHR	B3	SH8M11	C13	SLR-322MG	E15
RSB6.8ZS	C80	RU1C002ZP	C3	SCS212AJ	B3	SH8M12	C13	SLR-322VC	E15
RSBC6.8CM	C80	RU1E002SP	C3	SCS212AJHR	B3	SH8M13	C13	SLR-322VVR	E15
RSBC6.8CS	C80	RU1J002YN	C3	SCS212AM	B3	SH8M14	C13	SLR-322YC	E15
RSC002P03	C3	RU1L002SN	C3	SCS215AE	B3	SH8M24	C13	SLR-322YY	E15
RSF010P05	C6	RUC002N05	C3, C21	SCS215AG	B3	SH8M31	C13	SLR-325DC	E15
RSF014N03	C6	RUF015N02	C6	SCS215AGHR	B3	SH8M41	C13	SLR-325DU	E15
RSF015N06	C6, C21	RUF020N02	C6	SCS215AJ	B3	SH8M51	C13	SLR-325MC	E15
RSH040P03	C13	RUF025N02	C6, C21	SCS215AJHR	B3	SH8MA2	C13	SLR-325MG	E15
RSH050P03	C13	RUL035N02	C6, C21	SCS215AM	B3	SH8MA3	C13	SLR-325VC	E15
RSH065N06	C13	RUM001L02	C3	SCS215KG	B3	SH8MA4	C13	SLR-325VR	E15
RSH070N05	C13	RUM002N02	C3, C21	SCS215KGHR	B3	SIM-030ST	E30	SLR-325YC	E15
RSH070P05	C13	RUM002N05	C3	SCS220AE	B3	SIM-040ST	E30	SLR-325YY	E15
RSJ151P10	C17	RUQ050N02	C21	SCS220AE2	B3	SIM-20ST	E30	SLR-332DC	E14
RSJ250P10	C17, C23	RUR020N02	C7	SCS220AE2HR	B3	SIM-22ST	E30	SLR-332DU	E14
RSJ301N10	C17, C23	RUR040N02	C7, C21	SCS220AG	B3	SIR-341ST3F	E30	SLR-332MC	E14
RSJ400N06	C23	RV1C001ZP	C3	SCS220AGHR	B3	SIR-34ST3F	E30	SLR-332MG	E14
RSJ400N10	C17, C23	RV1C002UN	C3	SCS220AJ	B3	SIR-563ST3F	E30	SLR-332VC	E14
RSJ451N04	C23	RV2C001ZP	C3	SCS220AJHR	B3	SIR-568ST3F	E30	SLR-332VVR	E14
RSJ550N10	C17	RV2C002UN	C3	SCS220AM	B3	SIR-56ST3F	E30	SLR-332YC	E14
RSJ650N10	C17	RV2C010UN	C3	SCS220KE2	B3	SLA-360MT	E14	SLR-332YY	E14
RSL020P03	C21	RV2C014BC	C3	SCS220KE2HR	B3	SLA-370MT	E14	SLR-343DC	E14
RSM002N06	C3	RV2E012AT	C3	SCS220KG	B3	SLA-560MT	E14	SLR-343DU	E14
RSM002P03	C3	RV2E014AJ	C3	SCS220KGHR	B3	SLA-570MT	E14	SLR-343MC	E14
RSQ015N06	C7, C21	RV2L009GN	C3	SCS230AE2	B3	SLA-580MT	E14	SLR-343MG	E14
RSQ015P10	C21	RV3C001ZP	C3	SCS230AE2HR	B3	SLA560BC4T	E14	SLR-343PC	E14
RSQ020N03	C7, C21	RV3C002UN	C3	SCS230KE2	B3	SLA560BCT	E14	SLR-343PG	E14
RSQ025P03	C21	RV3CA01ZP	C3	SCS230KE2AHR	B3	SLA560BD2T	E14	SLR-343VC	E14
RSQ035N03	C21	RVQ040N05	C7, C21	SCS240AE2	B3	SLA560EC4T	E14	SLR-343VR	E14
RSQ035N06	C21	RW1A013ZP	C6	SCS240AE2HR	B3	SLA560ECT	E14	SLR-343YC	E14
RSQ035P03	C21	RW1A020ZP	C6	SCS240KE2	B3	SLA560WBD2PT	E14	SLR-343YY	E14
RSQ045N03	C21	RW1A025AP	C6	SCS240KE2AHR	B3	SLA580BC4T	E14	SLR-56DC	E14
RSR010N10	C21	RW1A030AP	C6	SCS302AP	B3	SLA580BCT	E14	SLR-56DU	E14
RSR015P06	C21	RW1C015UN	C6	SCS304AP	B3	SLA580EC4T	E14	SLR-56MC	E14
RSR020N06	C21	RW1C020UN	C6	SCS306AP	B3	SLA580ECT	E14	SLR-56MG	E14
RSR020P05	C21	RW1C025ZP	C6	SCS308AP	B3	SLD430BD2W	E15	SLR-56VC	E14
RSR025N03	C21	RW1E014SN	C6	SCS310AP	B3	SLD430WBD2PT	E15	SLR-56VR	E14
RSR025N05	C7, C21	RW1E015RP	C6	SCT2080KE	B5	SLI-325DC(W)	E15	SLR-56YC	E14
RSR025P03	C21	RW1E025RP	C6	SCT2080KEAHR	B5	SLI-325DU(W)	E15	SLR-56YY	E14
RSR030N06	C21	RX1G08CGN	C16	SCT2120AF	B5	SLI-325UR(W)	E15	SLR343BC4T	E14
RSS060P05	C22	RX1G18BGN	C16	SCT2160KE	B5	SLI-325URC(W)	E15	SLR343BCT	E14
RSS065N06	C22	RX1L06BGN	C16	SCT2160KEAHR	B5	SLI-325YC(W)	E15	SLR343BCT	E14
RSS070N05	C22	RX1L08BGN	C16	SCT2280KE	B5	SLI-325YY(W)	E15	SLR343BD2T	E14
RSS070P05	C22	RX1L16BGN	C16	SCT2280KEAHR	B5	SLI-343D8C	E14	SLR343EC4T	E14
RSS090N03	C22	RX1L18BGN	C16	SCT2450KE	B5	SLI-343D8U	E14	SLR343ECT	E14
RSS095N05	C22	RX1L18CGN	C16	SCT2450KEAHR	B5	SLI-343DC	E14	SLR343WBC7T	E14
RSS100N03	C22	RX1P08BBE	C16	SCT2750NY	B5	SLI-343DC(W)	E14	SLR343WBD2PT	E14
RSS130N03	C22	RXH070N03	C13	SCT2H12NY	B5	SLI-343DU	E14	SMF10V	C81
RSX051VAM30	C63	RXH090N03	C13	SCT2H12NZ	B5	SLI-343DU(W)	E14	SMF11V	C81
RSX051VYM30	C63	RXH100N03	C13	SCT3017AL	B5	SLI-343M8C	E14	SMF12V	C81
RSX071VAM30	C63	RXH125N03	C13	SCT3022AL	B5	SLI-343M8G	E14	SMF13V	C81
RSX071VYM30	C63	RXL035N03	C6	SCT3022KL	B5	SLI-343MC	E14	SMF14V	C81
RSX101MM-30	C67	RYC002N05	C3	SCT3030AL	B5	SLI-343MG	E14	SMF15V	C81
RSX101VAM30	C63	RYM002N05	C3	SCT3030KL	B5	SLI-343P8C	E14	SMF16V	C81
RSX101VYM30	C63	RZ2L18BGN	C17	SCT3040KL	B5	SLI-343P8G	E14	SMF18V	C81
RSX201LAM30	C67	RZ2L18CGN	C17	SCT3060AL	B5	SLI-343U8R	E14	SMF20V	C81
RSX201VAM30	C63	RZF013P01	C6	SCT3080AL	B5	SLI-343U8RC	E14	SMF22V	C81
RSX201VYM30	C63	RZF020P01	C6	SCT3080KL	B5	SLI-343UR	E14	SMF24V	C81
RSX205LAM30	C67	RZF030P01	C6	SCT3120AL	B5	SLI-343UR(W)	E14	SMF26V	C81
RSX301LAM30	C67	RZM001P02	C3	SCT3160KL	B5	SLI-343URC	E14	SMF28V	C81
RSX501LAM20	C67	RZM002P02	C3	SCTMU001F	B5	SLI-343URC(W)	E14	SMF30V	C81
RT1A045AP	C6	SCH2080KE	C3	SDR03	D8	SLI-343V8R	E14	SMF33V	C81
RT1A050ZP	C6	SCM-013RT	E8, E30	SDR10	D8	SLI-343V8RC	E14	SMF50V	C81
RT1A060AP	C6	SCM-014TB	E9, E31	SDZ Series	C76	SLI-343Y8C	E14	SMF60V	C81
RT1E040RP	C6	SCMP13WBC8W	E5	SFR01	D11	SLI-343Y8Y	E14	SMF6V5	C81
RT1E050RP	C6	SCS205KG	B3	SFR03	D11	SLI-343YC	E14	SMF70V	C81
RT1E060XN	C6	SCS205KGHR	B3	SFR10	D11	SLI-343YC(W)	E14	SMF7V5	C81
RTF016N05	C6, C21	SCS206AG	B3	SFR18	D11	SLI-343YY	E14	SMF8V0	C81
RTF025N03	C6, C21	SCS206AGHR	B3	SFR25	D11	SLI-343YY(W)	E14	SMF9V0	C81
RTL020P02	C21	SCS206AJ	B3	SH8J31	C13	SLI-430DU	E15	SML-522MD8W	E8
RTL035N03	C6, C21	SCS206AJHR	B3	SH8J62	C13	SLI-430MG	E15	SML-522MU8W	E8
RTQ020N03	C7	SCS206AM	B3	SH8J65	C13	SLI-430U2R	E15	SML-522MUW	E8
RTQ020N05	C7, C21	SCS208AG	B3	SH8J66	C13	SLI-430Y2U	E15	SML-522MY8W	E8
RTQ025P02	C21	SCS208AGHR	B3	SH8K10S	C13	SLI-560DT	E14	SML-810TB	E9, E31
RTQ035N03	C21	SCS208AJ	B3	SH8K11	C13	SLI-560UT	E14	SML-811DT(A)	E7
RTQ035P02	C21	SCS208AJHR	B3	SH8K12	C13	SLI-560YT	E14	SML-811UT(A)	E7
RTQ045N03	C21	SCS208AM	B3	SH8K25	C13	SLI-570DT	E14	SML-811VT(A)	E7
RTR020N05	C21	SCS210AG	B3	SH8K26	C13	SLI-570U2T	E14	SML-811WT(A)	E7
RTR020P02	C21	SCS210AGHR	B3	SH8K32	C13	SLI-570UT	E14	SML-812MT	E7
RTR025N03	C21	SCS210AJ	B3	SH8K37	C13	SLI-570Y2T	E14	SML-822MV8W	E7, E8
RTR025N05	C21	SCS210AJHR	B3	SH8K39	C13	SLI-570YT	E14	SML-825MVW	E7, E8
RTR025P02	C21	SCS210AM	B3	SH8K41	C13	SLI-580DT	E14	SML-A12D8T	E7
RTR030N05	C21	SCS210KE2	B3	SH8K52	C13	SLI-580UT	E14	SML-A12DT(J)	E7
RTR030P02	C21	SCS210KE2HR	B3	SH8KA1	C13	SLI-580YT	E14	SML-A12M8T	E7
RTR040N03	C21	SCS210KG	B3	SH8KA2	C13	SLR-322DC	E15	SML-A12MT(J)	E7
RU1C001UN	C3	SCS210KGHR	B3	SH8KA4	C13	SLR-322DU	E15	SML-A12P8T	E7
RU1C001ZP	C3	SCS212AG	B3	SH8KA7	C13	SLR-322MC	E15	SML-A12U8T	E7

Part No.	Page	Part No.	Page	Part No.	Page	Part No.	Page	Part No.	Page
SML-A12UT(J)	E7	SML-S13DT	E7	SST4403	C26	UMD12N	C50	USB 400J	F8
SML-A12V8T	E7	SML-S13MT	E7	SSTA06	C26	UMD22N	C50	UT6JA2	C11
SML-A12WT(J)	E7	SML-S13PT	E7	SSTA28	C26	UMD25N	C50	UT6JA3	C11
SML-A12Y8T	E7	SML-S13RT	E8, E30	SSTA56	C26	UMD2N	C50	UT6K3	C11
SML-A15YT	E7	SML-S13UT	E7	STM 300	F8	UMD3N	C50	UT6K30	C11
SML-D11YW	E5	SML-S13VT	E7	STM 320	F8	UMD4N	C50	UT6MA2	C11
SML-D12D1W	E5	SML-S13YT	E7	STM 331	F8	UMD5N	C50	UT6MA3	C11
SML-D12D8W	E5	SML-S15R2T	E8, E30	STM 400J	F8	UMD6N	C50	VMZ6.8N	C79
SML-D12FW	E5	SML-Z14D4T	E6	STM 429J	F8	UMD9N	C50	VS10VUA1LAM	C82
SML-D12M1W	E5	SML-Z14DT(A)	E6	STM 431J	F8	UMF28N	C35	VS11VUA1LAM	C82
SML-D12M8W	E5	SML-Z14F4T	E6	STZ5.6N	C79	UMF5N	C35	VS12VUA1LAM	C82
SML-D12P8W	E5	SML-Z14FT(A)	E6	STZ6.2N	C79	UMG11N	C52	VS13VUA1LAM	C82
SML-D12U1W	E5	SML-Z14M4T	E6	STZ6.8N	C79	UMG1N	C52	VS14VUA1LAM	C82
SML-D12U8W	E5	SML-Z14MT(A)	E6	STZ6.8T	C79	UMG2N	C52	VS15VUA1LAM	C82
SML-D12V1W	E5	SML-Z14P4T	E6	TCM 310	F8	UMG3N	C52	VS16VUA1LAM	C82
SML-D12V8W	E5	SML-Z14PT(A)	E6	TCM 410J	F8	UMG4N	C52	VS17VUA1LAM	C82
SML-D12W8W(A)	E5	SML-Z14U4T	E6	TCO Series (B case)	D25	UMG5N	C52	VS18VUA1LAM	C82
SML-D12Y1W	E5	SML-Z14UT(A)	E6	TCO Series (M case)	D22	UMG6N	C52	VS20VUA1LAM	C82
SML-D12Y3W	E5	SML-Z14V4T	E6	TCO Series (PL case)	D22	UMG8N	C52	VS22VUA1LAM	C82
SML-D12Y8W	E5	SML-Z14VT(A)	E6	TCO Series (PS case)	D22	UMG9N	C52	VS24VUA1LAM	C82
SML-D13DW(A)	E5	SML-Z14Y4T	E6	TCO Series (P case)	D22	UMH10N	C50	VS26VUA1LAM	C82
SML-D13FW	E5	SML-Z14YT(A)	E6	TCS Series (M case)	D26	UMH11N	C50	VS28VUA1LAM	C82
SML-D13M8W	E5	SML522BU1W	E8	TCS Series (PS case)	D26	UMH1N	C50	VS30VUA1LAM	C82
SML-D13MW(A)	E5	SML812BCT	E7	TCS Series (P case)	D26	UMH25N	C50	VS33BA1ES	C82
SML-D13U8W	E5	SML813WBC8W	E7	TCTO Series (AL case)	D24	UMH2N	C50	VS33BA1FS	C82
SML-D13UW(A)	E5	SMLA12EC6T	E7	TCTO Series (AS case)	D24	UMH32N	C53	VS33BB1ES	C82
SML-D13VW(A)	E5	SMLA12WBC7W	E7	TCTO Series (A case)	D24	UMH33N	C53	VS33BB1FS	C82
SML-D13WW(A)	E5	SMLA13BC8T	E7	TCTO Series (BL case)	D24	UMH37N	C53	VS33BC1HS	C82
SML-D13Y2W	E5	SMLD12BN1W	E5	TCTO Series (M case)	D23	UMH3N	C50	VS33BT1FS	C82
SML-D13Y8W	E5	SMLD12E2N1W	E5	TCTO Series (PL case)	D23	UMH4N	C50	VS5V0BA1ES	C82
SML-D14DW(A)	E5	SMLD12E3N1W	E5	TCTO Series (P case)	D23	UMH9N	C50	VS5V0BA1FS	C82
SML-D14MW(A)	E5	SMLD12EN1W	E5	TCTO Series (U2 case)	D23	UML1N	C35	VS5V0BB1ES	C82
SML-D14U2W(A)	E5	SMLD12WBN1W	E5	TCT Series (AL case)	D28	UML23N	C35	VS5V0BB1FS	C82
SML-D14VW(A)	E5	SML13EC8T	E5	TCT Series (AS case)	D28	UML2N	C35	VS5V0BC1ES	C82
SML-D14WW(A)	E5	SML13BC8T	E5	TCT Series (ML case)	D27	UML4N	C35	VS5V0BL1HS	C82
SML-D14YW(A)	E5	SML13WBC8W	E5	TCT Series (M case)	D27	UML6N	C35	VS5V0BN1HS	C82
SML-D15DW	E5	SMLK18WBJCW	E6	TCT Series (PL case)	D28	UMN10N	C84	VS5V0UA1LAM	C82
SML-D15MW	E5	SMLK18WBJDW	E6	TCT Series (P case)	D28	UMN1N	C84	VS6V0UA1LAM	C82
SML-D15U2W	E5	SMLK28WBJCW	E6	TCT Series (U case)	D27	UMN20N	C84	VS7V0UA1LAM	C82
SML-D15UW	E5	SMLMN2BCT(C)	E6	TC Series (A case)	D29	UMR12N	C84	VS8V0UA1LAM	C82
SML-D15VW	E5	SMLMN2ECT(C)	E6	TC Series (ML case)	D27	UMT18N	C33	VS9V0UA1LAM	C82
SML-D15YW	E5	SMLMN2WB1CW(C)	E6	TC Series (M case)	D27	UMT1N	C33	VT6J1	C3
SML-D22MUW	E5, E8	SMLP13BC8T	E5	TC Series (P case)	D29	UMT2222A	C26	VT6K1	C3
SML-D22YVW	E5, E8	SMLP13EC8T	E5	TC Series (U case)	D27	UMT2907A	C26	VT6M1	C3
SML-E12D8W	E5	SMLP13WBC9W	E5	TDZV Series	C77	UMT3904	C26	VT6T1	C33
SML-E12DW	E5	SMLP34RGB2W	E8	TFZV Series	C76	UMT3906	C26	VT6T11	C34
SML-E12M8W	E5	SMLP36RGB2W(R)	E8	TLR341	A14	UMT4401U3	C26	VT6T12	C34
SML-E12P8W	E5	SMLS14BET	E7	TLR342	A14	UMT4403U3	C26	VT6T2	C33
SML-E12U8W	E5	SMLS14EET	E7	TLR344	A14	UMX18N	C33	VT6X1	C33
SML-E12UW	E5	SMLVN6RGB1U	E8	TT8J11	C6	UMX1N	C33	VT6X11	C34
SML-E12V8W	E5	SMLVN6RGB1W	E8	TT8J13	C6	UMY1N	C33	VT6X12	C34
SML-E12Y8W	E5	SMLVN6RGB7W	E8	TT8J2	C6	UMZ12NUM	C79	VT6X2	C33
SML-H10TB	E9, E31	SMLZ14BGT(A)	E6	TT8J21	C6	UMZ16NUM	C79	VT6Z1	C33
SML-H12D8T	E6	SMLZ14EGT(A)	E6	TT8J3	C6	UMZ18NUM	C79	VT6Z2	C33
SML-H12M8T	E6	SMLZN4BGT(A)	E6	TT8K1	C6	UMZ1N	C33	YDZV Series	C77
SML-H12P8T	E6	SMLZN4WBGUW(A)	E6	TT8K11	C6	UMZ27NUM	C79	YFZV Series	C77
SML-H12U8T	E6	SMR003	D3	TT8K2	C6	UMZ30NUM	C79		
SML-H12V8T	E6	SP8J5	C22	TT8M1	C6	UMZ36NUM	C79		
SML-H12Y8T	E6	SP8J66	C22	TT8M11	C6	UMZ5.1NUM	C79		
SML-M13DT	E6	SP8K1	C22	TT8M2	C6	UMZ6.8EN	C79		
SML-M13MT	E6	SP8K2	C22	TT8M3	C6	UMZ6.8N	C79		
SML-M13PT	E6	SP8K22	C22	TT8U1	C9	UMZ8.2NUM	C79		
SML-M13RT	E8, E30	SP8K23	C22	TT8U2	C9	UMZK Series	C77		
SML-M13UT	E6	SP8K24	C22	UCR006	D13	US5U1	C9		
SML-M13VT	E6	SP8K3	C22	UCR01	D13	US5U2	C9		
SML-M13YT	E6	SP8K31	C22	UCR03	D13	US5U30	C9		
SML-P11DT(R)	E5	SP8K32	C22	UCR10	D13	US5U35	C9		
SML-P11MT(R)	E5	SP8K33	C22	UCR18	D13	US6H23	C53		
SML-P11UT(R)	E5	SP8K41	C22	UDZLV Series	C77	US6J11	C6		
SML-P11VT(R)	E5	SP8K5	C22	UDZV Series	C76	US6J12	C6		
SML-P11YT(R)	E5	SP8K52	C22	UFZV Series	C76	US6J41	C21		
SML-P12DT(R)	E5	SP8K80	C19	UM2222AU3	C26	US6K1	C6		
SML-P12M2T(R)	E5	SP8M10	C22	UM6J1N	C3	US6K2	C6		
SML-P12MT(R)	E5	SP8M21	C22	UM6K31N	C3, C21	US6K4	C6		
SML-P12U2T(R)	E5	SP8M24	C22	UM6K33N	C3	US6K41	C21		
SML-P12UT(R)	E5	SP8M3	C22	UM6K34N	C3	US6M1	C6		
SML-P12VT(R)	E5	SP8M4	C22	UMA1N	C52	US6M11	C6		
SML-P12WT(R)	E5	SP8M41	C22	UMA2N	C52	US6M2	C6		
SML-P12Y2T(R)	E5	SP8M5	C22	UMA3N	C52	US6T4	C29		
SML-P12Y3T(R)	E5	SP8M51	C22	UMA4N	C52	US6T5	C29		
SML-P12YT(R)	E5	SP8M6	C22	UMA5N	C52	US6T8	C36		
SML-P13FT(R)	E5	SP8M8	C22	UMA9N	C52	US6T9	C36		
SML-P13PT(R)	E5	SST2222A	C26	UMA10N	C50	US6X3	C29		
SML-P15DT(A)	E5	SST2907A	C26	UMB11N	C50	US6X4	C29		
SML-P15R2T	E8, E30	SST3904	C26	UMB2N	C50	US6X7	C36		
SML-P15UT(A)	E5	SST3906	C26	UMB3N	C50	US6X8	C36		
SML-P24MUW(R)	E8	SST4401	C26	UMB4N	C50	USB 300	F8		

The ROHM Sales Network



THE AMERICAS

1: Santa Clara / ROHM Semiconductor U.S.A., LLC
 2323 Owen Street, Santa Clara, CA 95054 U.S.A.
 TEL: +1-408-720-1900 FAX: +1-408-720-1918

2: Atlanta / ROHM Semiconductor U.S.A., LLC
 11680 Great Oaks Way, Suite A, Alpharetta, GA 30022 U.S.A.
 TEL: +1-770-754-5972 FAX: +1-770-754-0691

3: San Diego / ROHM Semiconductor U.S.A., LLC
 6020 Cornerstone Court West, Suite 320, San Diego, CA 92121 U.S.A.
 TEL: +1-858-625-3600 FAX: +1-858-625-3640

4: Sao Paulo / ROHM Semiconductor do Brasil Ltda.
 Rua Dr.Candido Espinheira, No.396, 12th floor, Rooms123 and 124,
 Bairro Perdizes, Sao Paulo SP 05004-000 Brasil
 TEL: +55-11-3539-6320 FAX: +55-11-4508-6213

5: Santa Clara / LAPIS Semiconductor America, Inc.
 2323 Owen Street, Santa Clara, CA 95054 U.S.A.
 TEL: +1-408-720-6223 FAX: +1-408-720-1921

EUROPE

6: Germany / ROHM Semiconductor GmbH
 Karl-Arnold-Strasse 15, 47877 Willich Germany
 TEL: +49-2154-921-0 FAX: +49-2154-921-400

7: France / ROHM Semiconductor GmbH
 40 rue d'Oradour sur Glane, 75015 Paris France
 TEL: +33(0)1 40 60 87 30 FAX: +33(0)1 40 60 63 44

8: United Kingdom / ROHM Semiconductor GmbH
 41 Sunningdale House, Caldecotte Lake Drive,
 Caldecotte Lake Business Park, Milton Keynes MK78LF UK
 TEL: +44-1-908-272400 FAX: +44-1-908-630011



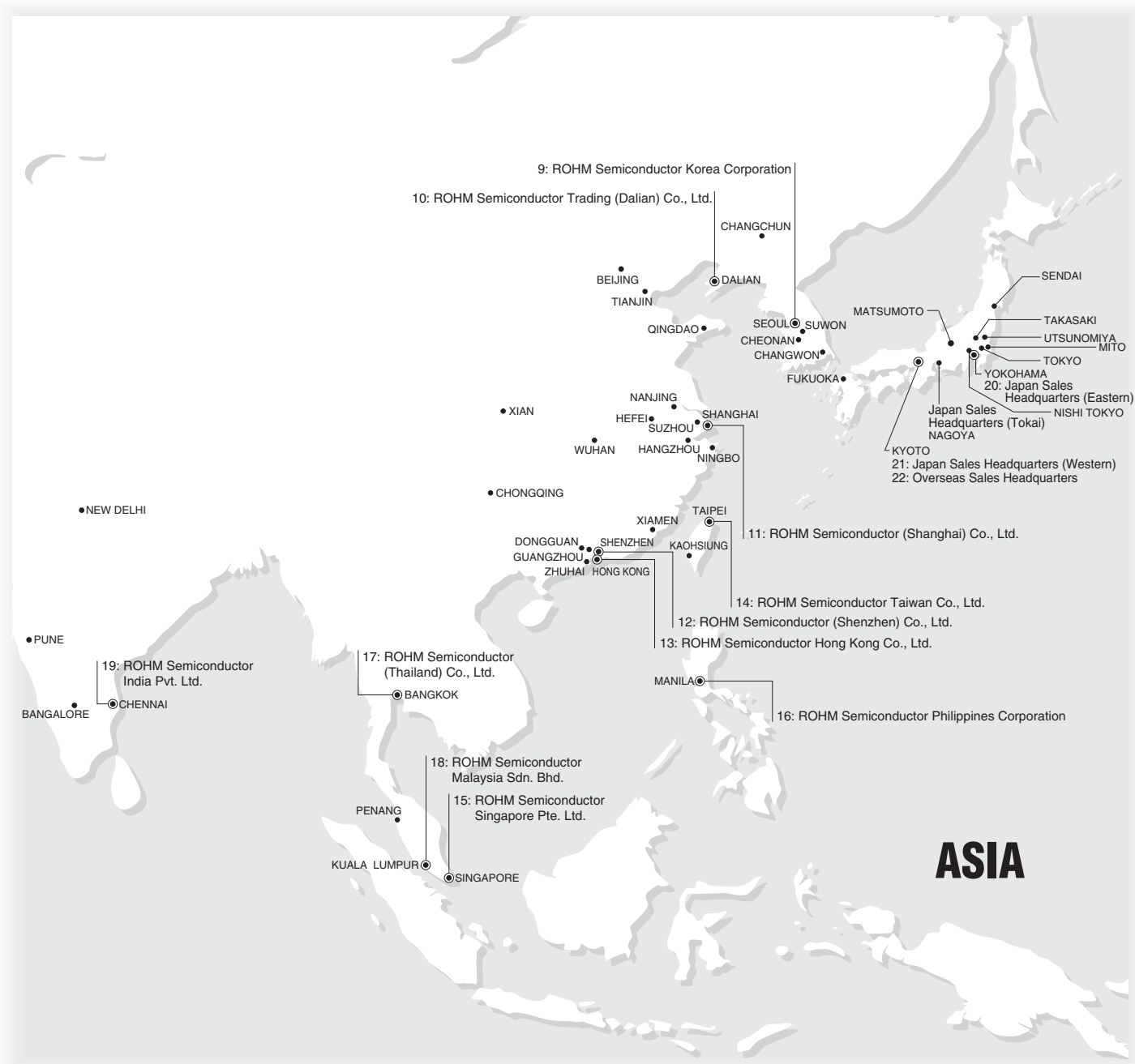

JAPAN

20: Japan

Sales Headquarters (Eastern)

ROHM Shin Yokohama Ekimae Building,
2-4-8 Shin Yokohama, Kohoku-ku, Yokohama 222-8575 JAPAN
TEL: +81-45- 476-2121 FAX: +81-45- 476-2295

21: Japan

Sales Headquarters (Western)

ROHM Kyoto Ekimae Building,
579-32 Higashi Shioikoji-cho, Karasuma Nishi-iru,
Shioikoji-dori, Shimogyo-ku, Kyoto 600-8216 Japan
TEL: +81-75-365-1077 FAX: +81-75-365-1080

22: Overseas Sales Headquarters

21, Saiin Mizosaki-cho, Ukyo-ku, Kyoto 615-8585 Japan
TEL: +81-75-311-2121 FAX: +81-75-315-0172

ASIA

9: Korea / ROHM Semiconductor Korea Corporation

159-13, Gasan Digital 1-ro, Geumcheon-gu, Seoul, 08506 Korea
TEL: +82-2-8182-700 FAX: +82-2-8182-715

10: Dalian / ROHM Semiconductor Trading (Dalian) Co., Ltd.

1201 Swish-hotel, 21 Wuhui Road, Zhong Shan District,
Dalian 116001 China
TEL: +86-411-8230-8549 FAX: +86-411-8230-8535

11: Shanghai / ROHM Semiconductor (Shanghai) Co., Ltd.

22F, CENTRAL TOWERS, 567 Langao Road,
Shanghai 200333 China
TEL: +86-21-6072-8612 FAX: +86-21-6072-8610

12: Shenzhen / ROHM Semiconductor (Shenzhen) Co., Ltd.

Room 02B-03 5/F Tower Two, Kerry Plaza, 1 Zhongxinsi Road,
Futian, Shenzhen 518048 China
TEL: +86-755-8307-3008 FAX: +86-755-8307-3003-101

13: Hong Kong / ROHM Semiconductor Hong Kong Co., Ltd.

Room 1402-08 Tower 1, Silvercord, 30 Canton Road,
Tsimshatsui, Kowloon, Hong Kong
TEL: +852-2740-6262 FAX: +852-2375-8971

14: Taiwan / ROHM Semiconductor Taiwan Co., Ltd.

11F No.6 Sec.3 Min Chuan E.Road, Taipei, Taiwan
TEL: +886-2-2500-6956 FAX: +886-2-2503-2869

15: Singapore / ROHM Semiconductor Singapore Pte. Ltd.

83 Clemenceau Avenue, #05-01 UE Square,
Singapore, 239920
TEL: +65-6436-5100 FAX: +65-6436-5190

16: Philippines / ROHM Semiconductor Philippines Corporation

Unit 4B Citibank-Frabelle Building, Madrigal Business Park,
Alabang-Zapote Road, Muntinlupa City 1770 Philippines
TEL: +63-2-807-6872 FAX: +63-2-809-1568

17: Thailand / ROHM Semiconductor (Thailand) Co., Ltd.

11th Floor GPF Witthayu Towers A 93/1 Wireless Road,
Lumpini, Pathumwan, Bangkok 10330 Thailand
TEL: +66-2-254-4890 FAX: +66-2-256-6334

18: Malaysia / ROHM Semiconductor Malaysia Sdn. Bhd.

L12-01-02, Level 12, PJX-HM Shah Tower, N016A, Persiaran Barat, 46050
Petaling Jaya, Selangor, Malaysia
TEL: +60-3-7931-8155 FAX: +60-3-7931-8955

19: India / ROHM Semiconductor India Pvt. Ltd.

Unit 4B&5, Level-2, Bagmane Laurel, Block B, Bagmane Tech Park,
C.V.Raman Nagar, Byrasandra, Bangalore-560093, India
TEL: +91-80-4125-0811 FAX: +91-80-4125-0813

Product Information

All product lineups from LAPIS Semiconductor and Kionix can now be accessed and searched directly on ROHM's website.

Products			
ICs <ul style="list-style-type: none"> Memory Amplifiers & Linear Power Management Clocks & Timers Switch & Multiplexer & Logic Data Converter Sensors & MEMS Digital Power (Povaporation) Display Drivers Motor / Actuator Drivers Interface Communication LSI (LAPIS) Audio & Video Speech Synthesis LSI (LAPIS) Microcontrollers (LAPIS) 	Discrete Semiconductors <ul style="list-style-type: none"> Transistors Diodes 	Passive Devices <ul style="list-style-type: none"> Resistors Tantalum Capacitors 	Commercial Products <ul style="list-style-type: none"> Intel Chipset
Power Devices <ul style="list-style-type: none"> SIC Power Devices IGBT IPM 	Opto Devices <ul style="list-style-type: none"> LED LED Displays Laser Diodes Optical Sensors 	Modules (Sub Systems) <ul style="list-style-type: none"> Power Modules Wireless Communication Modules Contact Image Sensor Heads Printheads Batteryless Radio Module (EnOcean) 	

LAPIS Product Page
Find LAPIS Semiconductor products, such as logic ICs, memory, and display drivers.

Kionix Product Page
Search through Kionix's entire portfolio of products, including sensors and MEMS devices.

High Performance DC/DC CONVERTERS
Broad lineup optimized for a variety of needs

- Fast transient response
- Superior light load efficiency
- Compact form factor

Products

- ICs
- Discrete Semiconductors
- Passive Devices
- Commercial Products

Design Simulation Models
Access emulation models, including SPICE, Thermal, and timing models.

White Paper and Selection Guides
Access various white papers and selection guides available for the range of ROHM products.

ROHM's Electronic Laboratory
ROHM's online design tool, ROHM Electronic Laboratory (REL), allows designers to evaluate products and circuits directly from the web.

Distribution Inventory
Search for thousands of ROHM products in stock every day at any one of our global distributors.

News
2017-08-01 Posted 1st quarter financial results and related documents for fiscal year ending March 31, 2018
2017-07-11 New Evaluation Boards for USB Type-C USB Power Delivery
2017-06-29 Posted the notice of resolution of the 56th Ordinary General Meeting of Shareholders
2017-06-29 ROHM's Automated Machine Health Monitoring Solution

Affiliates
LAPIS SEMICONDUCTOR, Kionix, siCrystal, Intel, Renesas

Design Tools and Support

Design support such as tools and services are provided.

Design Simulation Models
Access emulation models, including SPICE/IBIS models and thermal/frequency characteristics, for hundreds of ROHM products.

White Papers And Selection Guides
Access white papers and selection guides for a range of ROHM products.

ROHM's online design tool
ROHM's online design tool allows designers to evaluate products and circuits directly from the web.

Distribution Inventory
Search online for thousands of in-stock ROHM products at one of our global distributors.

Design Simulation Models

Access emulation models, including SPICE/IBIS models and thermal/frequency characteristics, for hundreds of ROHM products.

White Papers And Selection Guides

Access white papers and selection guides for a range of ROHM products.

ROHM's online design tool

ROHM's online design tool allows designers to evaluate products and circuits directly from the web.

Distribution Inventory

Search online for thousands of in-stock ROHM products at one of our global distributors.

Products and Services

Includes new product announcements (i.e. ICs and modules) and downloadable materials such as product datasheets.

8bit MCU Lineup CSV Parametric search for detailed information >

Searching function On/Off

Show/Hide	Download	Operating voltage (V)	Operating temperature (°C)	ROM type	ROM (Byte)	RAM (Byte)	LCD	Remarks	PKG	Chip support	Sample and Buy
	+ Datasheet + Manual + Errata	1.25 to 3.6	-20 to +70	Mask	6K	192	Max. 55dot 11seg. x 5com.	Selectable oscillation stop detection reset function enable according to softwareLCD bias : 1/3	-	Yes	

Latest News

Access the latest news and information, including Press Releases and New Product Bulletins.

NOR Flash Memory 128Mb "MR29V12852B"

New High Reliability NOR Flash Memory Ideal for Automotive and Industrial Applications

~ 128Mb memory features the industry's first error correcting code circuit for stable system operation and lower costs ~

Apr 22, 2016

Summary

ROHM Group company LAPIS Semiconductor has recently announced the availability of 128Mb NOR Flash memory optimized for data storage in automotive and industrial systems that demand superior quality. Flash memory is categorized into NAND and NOR types depending on how the memory cells (which store data) are connected. NAND, which is characterized by low cost per bit, is primarily adopted as a digital data storage medium for mobile phones, digital cameras, and digital audio devices, while NOR provides high reliability and is often used to store firmware in automotive systems and industrial equipment where high quality is required. Unfortunately, however, non-volatile memory such as Flash are susceptible to accidental data errors, prompting high reliability applications to adopt measures that prevent programs from malfunctioning or stopping due to data error to ensure stable system operation. Data errors in Flash memory are primarily caused by memory read data error (bit error) or electrical noise (radiation noise) generated during data switching, which can lead to signal delay and/or waveform distortion and, ultimately, data communication error between the Flash memory and controller. This greatly affects system reliability. To combat this, many systems typically utilize a bit error correction function to minimize bit errors and implement board design and component layout (and evaluation) that incorporate countermeasures to prevent noise from being

Support Page

Download useful development materials and software updates.

- *Registration required.
- *Some content requires the development board serial number.

Contact us for further information about the products.

[THE AMERICAS]

Santa Clara 2323 Owen Street, Santa Clara CA 95054 U.S.A.
TEL: +1-408-720-1900 FAX: +1-408-720-1918

Atlanta 11680 Great Oaks Way, Suite A, Alpharetta, GA 30022 U.S.A.
TEL: +1-770-754-5972 FAX: +1-770-754-0691

Chicago 21925 W Field Pkway, Suite 206 Deer Park, IL 60010 U.S.A.
TEL: +1-847-368-1006 FAX: +1-847-368-1008

Denver 16-A Inverness Place East, Suite 200, Englewood, CO 80112 U.S.A.
TEL: +1-303-708-0908 FAX: +1-303-708-0858

Detroit 26800 Meadowbrook Road, Suite 120, Novi, MI 48377 U.S.A.
TEL: +1-248-348-9920 FAX: +1-248-348-9942

San Diego 6020 Cornerstone Court West, Suite 320, San Diego, CA 92121 U.S.A.
TEL: +1-858-625-3600 FAX: +1-858-625-3640

Mexico Av. Lazaro Cardenas #4135-PH, Jardines De San Ignacio, Zapopan,
Jalisco 45040 Mexico
TEL: +52-33-3123-2001 FAX: +52-33-3123-2002

Brasil Rua Dr.Candido Espinheira, No.396, 12th floor, Rooms123 and 124,
Bairro Perdizes, Sao Paulo SP 05004-000 Brasil
TEL: +55-11-3539-6320 FAX: +55-11-4508-6213

[ASIA]

Seoul 159-13, Gasan Digital 1-ro, Geumcheon-gu, Seoul, 08506 Korea
TEL: +82-2-8182-700 FAX: +82-2-8182-715

Dalian 1201 Swish-hotel, 21 Wuhui Road, Zhong Shan District, Dalian 116001 China
TEL: +86-411-8230-8549 FAX: +86-411-8230-8535

Shanghai 22F. CENTRAL TOWERS, 567 Langao Road, Shanghai 200333 China
TEL: +86-21-6072-8612 FAX: +86-21-6072-8610

Shenzhen Room 02B-03 5/F Tower Two, Kerry Plaza, 1 Zhongxinsi Road, Futian,
Shenzhen 518048 China
TEL: +86-755-8307-3008 FAX: +86-755-8307-3003-101

Hong Kong Room 1402-08 Tower 1, Silvercord, 30 Canton Road, Tsimshatsui, Kowloon,
Hong Kong
TEL: +852-2740-6262 FAX: +852-2375-8971

Taiwan 11F No.6 Sec.3 Min Chuan E. Road, Taipei, Taiwan
TEL: +886-2-2500-6956 FAX: +886-2-2503-2869

Singapore 83 Clemenceau Avenue, #05-01 UE Square, Singapore, 239920
TEL: +65-6436-5100 FAX: +65-6436-5190

Philippines Unit 4B Citibank-Frabelle Building, Madrigal Business Park, Alabang-Zapote Road,
Muntinlupa City 1770 Philippines
TEL: +63-2-807-6872 FAX: +63-2-809-1568

Thailand 11th Floor GPF Withhayu Towers A, 93/1 Wireless Road, Lumpini,
Pathumwan, Bangkok 10330 Thailand
TEL: +66-2-254-4890 FAX: +66-2-256-6334

Malaysia L12-01-02, Level 12, PJX-HM Shah Tower, NO16A, Persiaran Barat,
46050 Petaling Jaya, Selangor, Malaysia
TEL: +60-3-7931-8155 FAX: +60-3-7931-8955

India Unit 4B&5, Level-2, Bagmane Laurel, Block B, Bagmane Tech Park,
C.V.Raman Nagar, Byrasandra, Bangalore-560093, India
TEL: +91-80-4125-0811 FAX: +91-80-4125-0813

[EUROPE]

Düsseldorf Karl-Arnold-Strasse 15, 47877 Willich Germany
TEL: +49-2154-921-0 FAX: +49-2154-921-400

Germany Zettachring 6, 70567 Stuttgart Germany
TEL: +49-711-7272370 FAX: +49-711-72723720

France 40 rue d' Oradour sur Glane, 75015 Paris France
TEL: +33 (0)1 40 60 87 30 FAX: +33 (0)1 40 60 63 44

United Kingdom 41 Sunningdale House, Caldecotte Lake Business Park,
Milton Keynes MK78LF UK
TEL: +44-1-908-272400 FAX: +44-1-908-630011

Finland Kiviharjuntie 11, 90220 Oulu Finland
TEL: +358-400-726124

Spain c/Sant Christofol, 25 Local A+B, Premia de Mar, 08330 Barcelona Spain
TEL: +34-9375-24320 FAX: +34-9375-24410

Hungary Fehérvári út 84/A, I em. HUN-1119 Budapest Hungary
TEL: +36-1-950-5859

Russia 13F Office No.1301 Savelkinskiy proezd 4, 124482 Moscow Zelenograd Russia
TEL: +74 95 739 4174 FAX: +74 95 739 4174

[JAPAN]

Kyoto 579-32 Higashi Shiokoji-cho, Karasuma Nishi-iru, Shiokoji-dori, Shimogyo-ku,
Kyoto 600-8216 Japan
TEL: +81-75-365-1218 FAX: +81-75-365-1228

Yokohama 2-4-8, Shin Yokohama, Kohoku-ku, Yokohama 222-8575 Japan
TEL: +81-45-476-2289 FAX: +81-45-476-2295

Notes

- 1) The information contained in this document is provided as of 1st. October, 2017.
 - 2) The information contained herein is subject to change without notice. Before you use our Products, please contact our sales representative (as listed below) and verify the before page specifications.
 - 3) Although "ROHM group" (It is said here in after refers to ROHM) is continuously working to improve product reliability and quality, semiconductors can break down and malfunction due to various factors. Therefore, in order to prevent personal injury or fire arising from failure, please take safety measures such as complying with the derating characteristics, implementing redundant and fire prevention designs, and utilizing backups and fail-safe procedures. ROHM shall have no responsibility for any damages arising out of the use of our Products beyond the rating specified by ROHM.
 - 4) Examples of application circuits, circuit constants and any other information contained herein are provided only to illustrate the standard usage and operations of the Products. The peripheral conditions must be taken into account when designing circuits for mass production.
 - 5) The technical information specified herein is intended only to show the typical functions of and examples of application circuits for the Products. ROHM does not grant you, explicitly or implicitly, any license to use or exercise intellectual property or other rights held by ROHM or any other parties. ROHM shall have no responsibility whatsoever for any dispute arising out of the use of such technical information.
 - 6) The Products are intended for use in general electronic equipment (i.e. AV/OA devices, communication, consumer systems, gaming/entertainment sets) as well as the applications indicated in this document.
 - 7) The Products specified in this document are not designed to be radiation tolerant.
 - 8) For use of our Products in applications requiring a high degree of reliability (as exemplified below), please contact and consult with a ROHM representative: transportation equipment (i.e. cars, ships, trains), primary communication equipment, traffic lights, fire/crime prevention, safety equipment, medical systems, servers, solar cells, and power transmission systems.
 - 9) Do not use our Products in applications requiring extremely high reliability, such as aerospace equipment, nuclear power control systems, and submarine repeaters.
 - 10) ROHM shall have no responsibility for any damages or injury arising from non-compliance with the recommended usage conditions and specifications contained herein.
 - 11) ROHM has used reasonable care to ensure the accuracy of the information contained in this document. However, ROHM does not warrant that such information is error-free and ROHM shall have no responsibility for any damages arising from any inaccuracy or misprint of such information.
 - 12) Please use the Products in accordance with any applicable environmental laws and regulations, such as the RoHS Directive. For more details, including RoHS compatibility, please contact a ROHM sales office as listed the before page. ROHM shall have no responsibility for any damages or losses resulting non-compliance with any applicable laws or regulations.
 - 13) When providing our Products and technologies contained in this document to other countries, you must abide by the procedures and provisions stipulated in all applicable export laws and regulations, including without limitation the US Export Administration Regulations and the Foreign Exchange and Foreign Trade Act.
 - 14) This document, in part or in whole, may not be reprinted or reproduced without prior consent of ROHM.
-

[Compliance to RoHS Directive]

All of the products comply with the RoHS Directive.
With the exception of specific exemptions granted under the RoHS Directive and naturally occurring impurities, the products conform to control limits on the six substances regulated by the RoHS Directive (lead, cadmium, mercury, hexavalent chromium, PBB, and PBDE). Indicates that the product's terminals and electrodes contain no lead. The products internal components other than those specifically exempted under the RoHS Directive. It should not be construed as guarantee of compliance with laws and regulations enacted by EU member states in response to the RoHS Directive.

ROHM
SEMICONDUCTOR

ROHM Co.,Ltd.

21 Saiin Mizosaki-cho, Ukyo-ku,
Kyoto 615-8585 Japan
TEL : +81-75-311-2121 FAX : +81-75-315-0172
<http://www.rohm.com>

ROHM GROUP
LAPIS
SEMICONDUCTOR

